



THE DATASHEET OF CNY64ABST





Optocoupler, Phototransistor Output, Very High Isolation Voltage

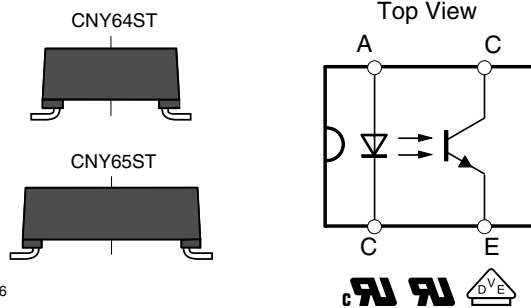

17187-6

FEATURES

- Rated recurring peak voltage (repetitive) $V_{IORM} = 1800 V_{peak}$
- Thickness through insulation ≥ 3 mm
- Creepage current resistance according to VDE 0303 / IEC 60112 comparative tracking index: **CTI ≥ 475**
- Moisture sensitivity level MSL4
 - Follow defined storage and soldering requirements
- Material categorization: for definitions of compliance please see www.vishay.com/doc?99912



LINKS TO ADDITIONAL RESOURCES



DESCRIPTION

The CNY6XST, the high isolation voltage SMD version optocouplers consist of a phototransistor optically coupled to a gallium arsenide infrared-emitting diode in a 4 pin plastic package.

The single components are mounted opposite one another, providing a distance between input and output for highest safety requirements of > 3 mm.

VDE STANDARDS

These couplers perform safety functions according to the following equipment standards:

- **DIN EN 60747-5-5 (VDE 0884-5)**
Optocoupler for electrical safety requirements
- **IEC 60065**
Safety for mains-operated electronic and related household apparatus
- **VDE 0160**
Electronic equipment for electrical power installation

APPLICATIONS

- Solar and wind power diagnostic, monitoring, and communication equipment
- Welding equipment
- High voltage motors
- Switch-mode power supplies
- Line receiver
- Computer peripheral interface
- Microprocessor system interface
- Circuits for safe protective separation against electrical shock according to safety class II (reinforced isolation):
 - for appl. class I to IV at mains voltage ≤ 300 V
 - for appl. class I to IV at mains voltage ≤ 600 V
 - for appl. class I to III at mains voltage ≤ 1000 V according to DIN EN 60747-5-5 (VDE 0884-5)

AGENCY APPROVALS

- [UL 1577](#)
- [cUL 1577](#)
- [DIN EN 60747-5-5 \(VDE 0884-5\)](#)
- [CQC](#)

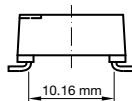
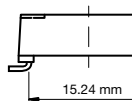
ORDERING INFORMATION																								
<table border="1" style="width: 100%; border-collapse: collapse;"> <tr> <td style="text-align: center;">C</td> <td style="text-align: center;">N</td> <td style="text-align: center;">Y</td> <td style="text-align: center;">6</td> <td style="text-align: center;">#</td> <td style="text-align: center;">X</td> <td style="text-align: center;">X</td> <td style="text-align: center;">X</td> <td style="text-align: center;">S</td> <td style="text-align: center;">T</td> </tr> <tr> <td colspan="4" style="text-align: center;">PART NUMBER</td> <td style="text-align: center;">PACKAGE OPTION</td> <td colspan="5" style="text-align: center;">CTR BIN</td> </tr> </table>	C	N	Y	6	#	X	X	X	S	T	PART NUMBER				PACKAGE OPTION	CTR BIN								
C	N	Y	6	#	X	X	X	S	T															
PART NUMBER				PACKAGE OPTION	CTR BIN																			
AGENCY CERTIFIED/PACKAGE	CTR (%)																							
	5 mA																							
UL, cUL, VDE	50 to 300	50 to 150	80 to 240	100 to 300																				
SMD-4 HV, 400 mil high isolation distance	CNY64ST	CNY64AYST	CNY64ABST	CNY64AGRST																				
SMD-4 HV, 600 mil high isolation distance	CNY65ST	CNY65AYST	CNY65ABST	CNY65AGRST																				



ABSOLUTE MAXIMUM RATINGS (T _{amb} = 25 °C, unless otherwise specified)				
PARAMETER	TEST CONDITION	SYMBOL	VALUE	UNIT
INPUT				
Reverse voltage		V _R	5	V
Forward current		I _F	75	mA
Forward surge current	t _p ≤ 10 μs	I _{FSM}	1.5	A
Power dissipation		P _{diss}	120	mW
Junction temperature		T _j	100	°C
OUTPUT				
Collector emitter voltage		V _{CEO}	32	V
Emitter collector voltage		V _{ECO}	7	V
Collector current		I _C	50	mA
Collector peak current	t _p /T = 0.5, t _p ≤ 10 ms	I _{CM}	100	mA
Power dissipation		P _{diss}	130	mW
Junction temperature		T _j	100	°C
COUPLER				
Total power dissipation		P _{tot}	250	mW
Ambient temperature range		T _{amb}	-55 to +85	°C
Storage temperature range		T _{stg}	-55 to +100	°C
Soldering temperature	See reflow profile in "Soldering Guidelines"	T _{sld}	245	°C

Note

- Stresses in excess of the absolute maximum ratings can cause permanent damage to the device. Functional operation of the device is not implied at these or any other conditions in excess of those given in the operational sections of this document. Exposure to absolute maximum ratings for extended periods of the time can adversely affect reliability.

ELECTRICAL CHARACTERISTICS (T _{amb} = 25 °C, unless otherwise specified)						
PARAMETER	TEST CONDITION	SYMBOL	MIN.	TYP.	MAX.	UNIT
INPUT						
Forward voltage	I _F = 50 mA	V _F	-	1.32	1.6	V
Junction capacitance	V _R = 0 V, f = 1 MHz	C _j	-	50	-	pF
OUTPUT						
Collector emitter voltage	I _C = 1 mA	V _{CEO}	32	-	-	V
Emitter collector voltage	I _E = 100 μA	V _{ECO}	7	-	-	V
Collector emitter leakage current	V _{CE} = 20 V, I _F = 0 mA	I _{CEO}	-	-	200	nA
COUPLER						
Collector emitter saturation voltage	I _F = 10 mA, I _C = 1 mA	V _{CEsat}	-	-	0.3	V
Cut-off frequency	V _{CE} = 5 V, I _F = 10 mA, R _L = 100 Ω	f _c	-	110	-	kHz
Coupling capacitance	f = 1 MHz	C _k	-	0.3	-	pF

Note

- Minimum and maximum values are testing requirements. Typical values are characteristics of the device and are the result of engineering evaluation. Typical values are for information only and are not part of the testing requirements.

CURRENT TRANSFER RATIO (T _{amb} = 25 °C, unless otherwise specified)							
PARAMETER	TEST CONDITION	PART	SYMBOL	MIN.	TYP.	MAX.	UNIT
I _C /I _F	V _{CE} = 5 V, I _F = 5 mA	CNY64ST	CTR	50	-	300	%
		CNY65ST	CTR	50	-	300	%
		CNY64AYST	CTR	50	-	150	%
		CNY65AYST	CTR	50	-	150	%
		CNY64ABST	CTR	80	-	240	%
		CNY65ABST	CTR	80	-	240	%
		CNY64AGRST	CTR	100	-	300	%
		CNY65AGRST	CTR	100	-	300	%

SWITCHING CHARACTERISTICS						
PARAMETER	TEST CONDITION	SYMBOL	MIN.	TYP.	MAX.	UNIT
Delay time	$V_S = 5\text{ V}$, $I_C = 5\text{ mA}$, $R_L = 100\ \Omega$, (see Fig. 3)	t_d	-	2.6	-	μs
Rise time	$V_S = 5\text{ V}$, $I_C = 5\text{ mA}$, $R_L = 100\ \Omega$, (see Fig. 3)	t_r	-	2.4	-	μs
Fall time	$V_S = 5\text{ V}$, $I_C = 5\text{ mA}$, $R_L = 100\ \Omega$, (see Fig. 3)	t_f	-	2.7	-	μs
Storage time	$V_S = 5\text{ V}$, $I_C = 5\text{ mA}$, $R_L = 100\ \Omega$, (see Fig. 3)	t_s	-	0.3	-	μs
Turn-on time	$V_S = 5\text{ V}$, $I_C = 5\text{ mA}$, $R_L = 100\ \Omega$, (see Fig. 3)	t_{on}	-	5	-	μs
Turn-off time	$V_S = 5\text{ V}$, $I_C = 5\text{ mA}$, $R_L = 100\ \Omega$, (see Fig. 3)	t_{off}	-	3	-	μs
Turn-on time	$V_S = 5\text{ V}$, $I_F = 10\text{ mA}$, $R_L = 1\text{ k}\Omega$, (see Fig. 4)	t_{on}	-	25	-	μs
Turn-off time	$V_S = 5\text{ V}$, $I_F = 10\text{ mA}$, $R_L = 1\text{ k}\Omega$, (see Fig. 4)	t_{off}	-	42.5	-	μs

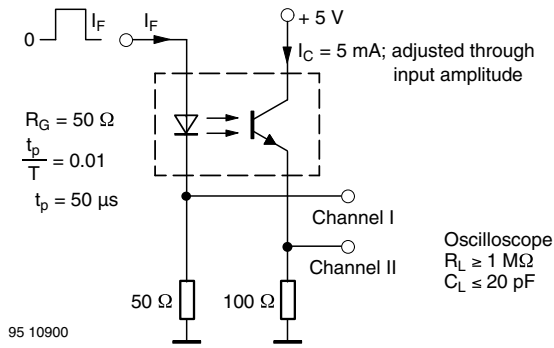

Fig. 1 - Test Circuit, Non-Saturated Operation

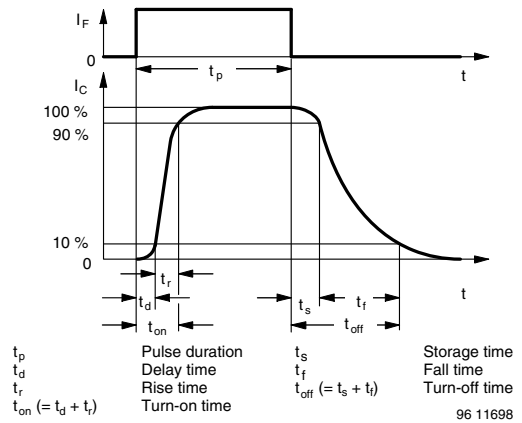

Fig. 3 - Switching Times

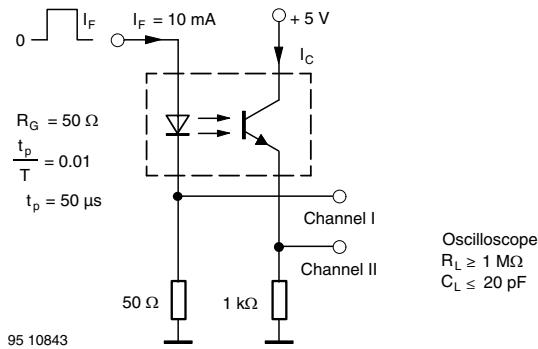

Fig. 2 - Test Circuit, Saturated Operation



SAFETY AND INSULATION RATINGS				
PARAMETER	TEST CONDITION	SYMBOL	VALUE	UNIT
Climatic classification	According to IEC 68 part 1		55 / 85 / 21	
Pollution degree	According to DIN VDE 0109		2	
Comparative tracking index	Insulation group II	CTI	475	
Maximum rated withstanding isolation voltage	According to UL1577, t = 1 min	V_{ISO}	8200	V_{RMS}
Tested withstanding isolation voltage	According to UL1577, t = 1 s	V_{ISO}	13 900	V_{peak}
Maximum transient isolation voltage	According to DIN EN 60747-5-5	V_{IOTM}	12 000	V_{peak}
Maximum repetitive peak isolation voltage	According to DIN EN 60747-5-5	V_{IORM}	1800	V_{peak}
Isolation resistance	$T_{amb} = 25\text{ }^{\circ}\text{C}$, $V_{IO} = 500\text{ V}$	R_{IO}	$\geq 10^{12}$	Ω
	$T_{amb} = 100\text{ }^{\circ}\text{C}$, $V_{IO} = 500\text{ V}$	R_{IO}	$\geq 10^{11}$	Ω
	$T_{amb} = TS$, $V_{IO} = 500\text{ V}$	R_{IO}	$\geq 10^9$	Ω
Output safety power		P_{SO}	250	mW
Input safety current		I_{SI}	120	mA
Input safety temperature		T_S	150	$^{\circ}\text{C}$
Creepage distance	CNY64		≥ 9.5	mm
Clearance distance			≥ 9.5	mm
Creepage distance	CNY65		≥ 14	mm
Clearance distance			≥ 14	mm
Insulation thickness		DTI	≥ 3	mm
Input to output test voltage, method B	$V_{IORM} \times 1.875 = V_{PR}$, 100 % production test with $t_M = 1\text{ s}$, partial discharge $< 5\text{ pC}$	V_{PR}	3375	V_{peak}
Input to output test voltage, method A	$V_{IORM} \times 1.6 = V_{PR}$, 100 % sample test with $t_M = 10\text{ s}$, partial discharge $< 5\text{ pC}$	V_{PR}	2880	V_{peak}

Note

- According to DIN EN 60747-5-5 (see Fig. 5). This optocoupler is suitable for safe electrical isolation only within the safety ratings. Compliance with the safety ratings shall be ensured by means of suitable protective circuits.

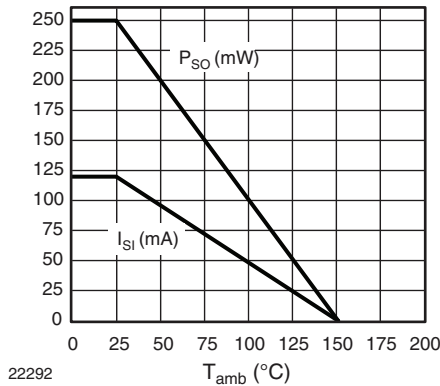

Fig. 4 - Safety Derating Diagram

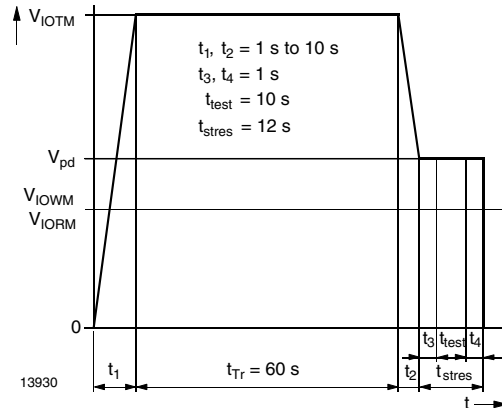

Fig. 5 - Test Pulse Diagram for Sample Test According to DIN EN 60747-5-5 (VDE 0884-5); IEC60747-5-5



TYPICAL CHARACTERISTICS (T_{amb} = 25 °C, unless otherwise specified)

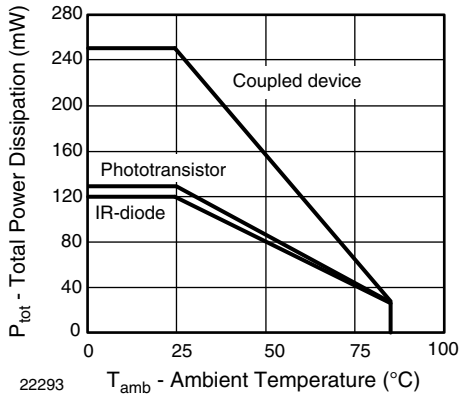

Fig. 6 - Total Power Dissipation vs. Ambient Temperature

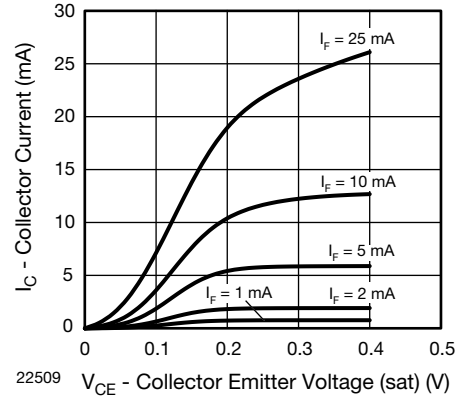

Fig. 9 - Collector Current vs. Collector Emitter Voltage

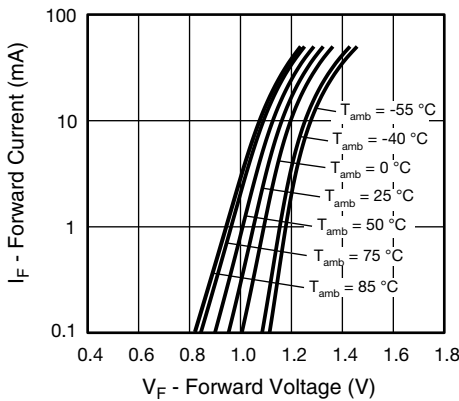

Fig. 7 - Forward Current vs. Forward Voltage

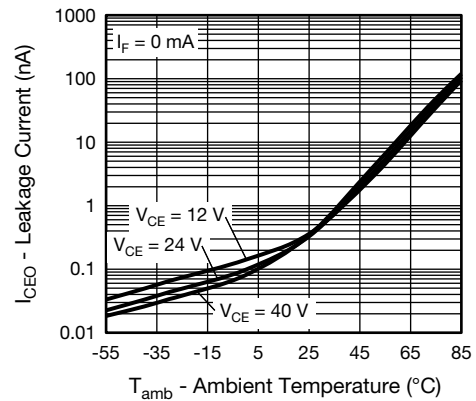

Fig. 10 - Leakage Current vs. Ambient Temperature

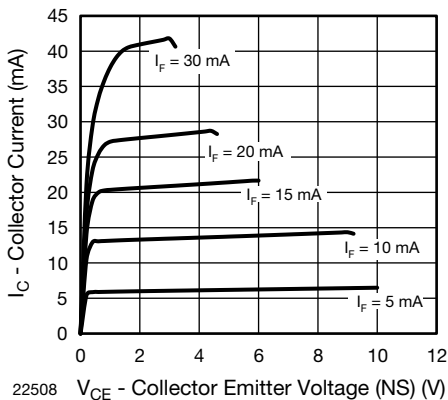

Fig. 8 - Collector Current vs. Collector Emitter Voltage (non-saturated)

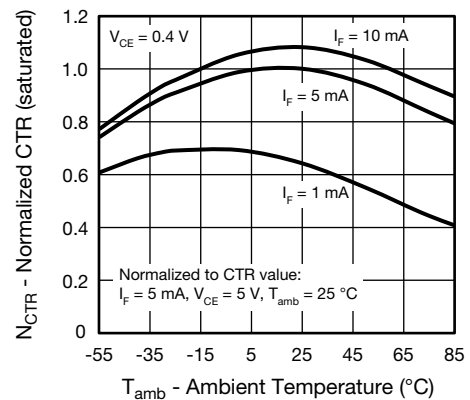

Fig. 11 - Normalized CTR (saturated) vs. Ambient Temperature

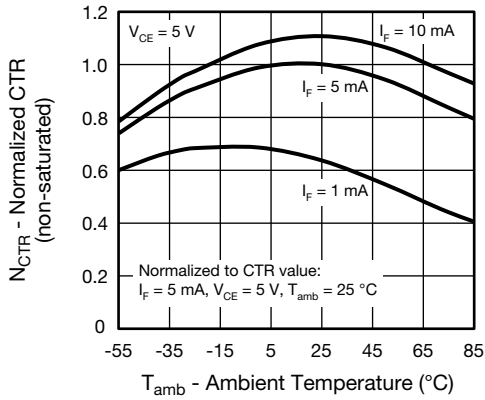

Fig. 12 - Normalized CTR (non-saturated) vs. Ambient Temperature

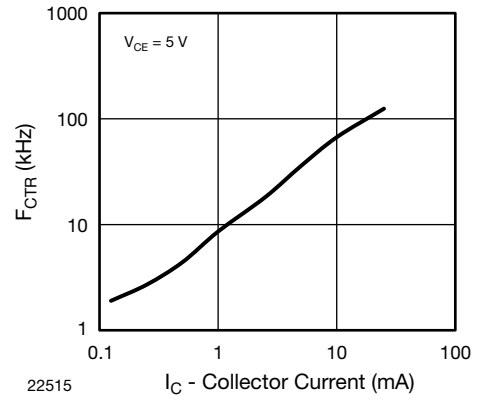

Fig. 15 - F_{CTR} vs. Collector Current

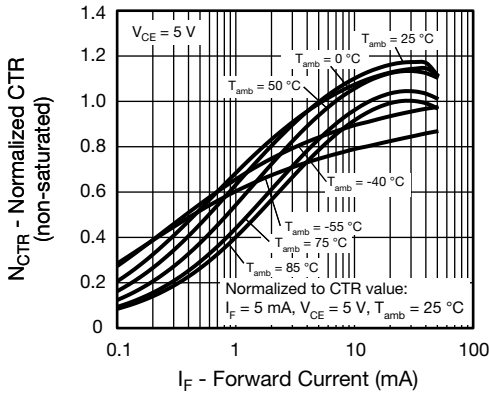

Fig. 13 - Normalized CTR (non-saturated) vs. Forward Current

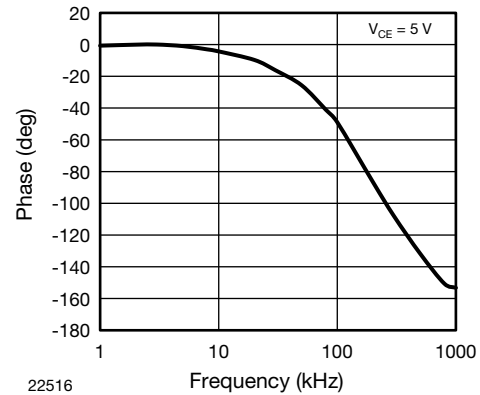

Fig. 16 - F_{CTR} vs. Phase Angle

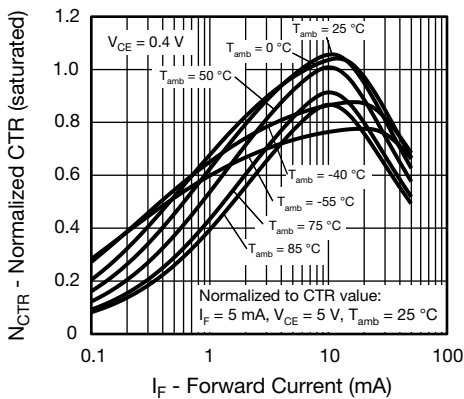

Fig. 14 - Normalized CTR (saturated) vs. Forward Current

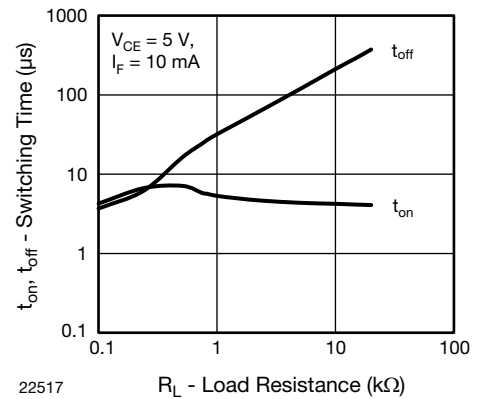
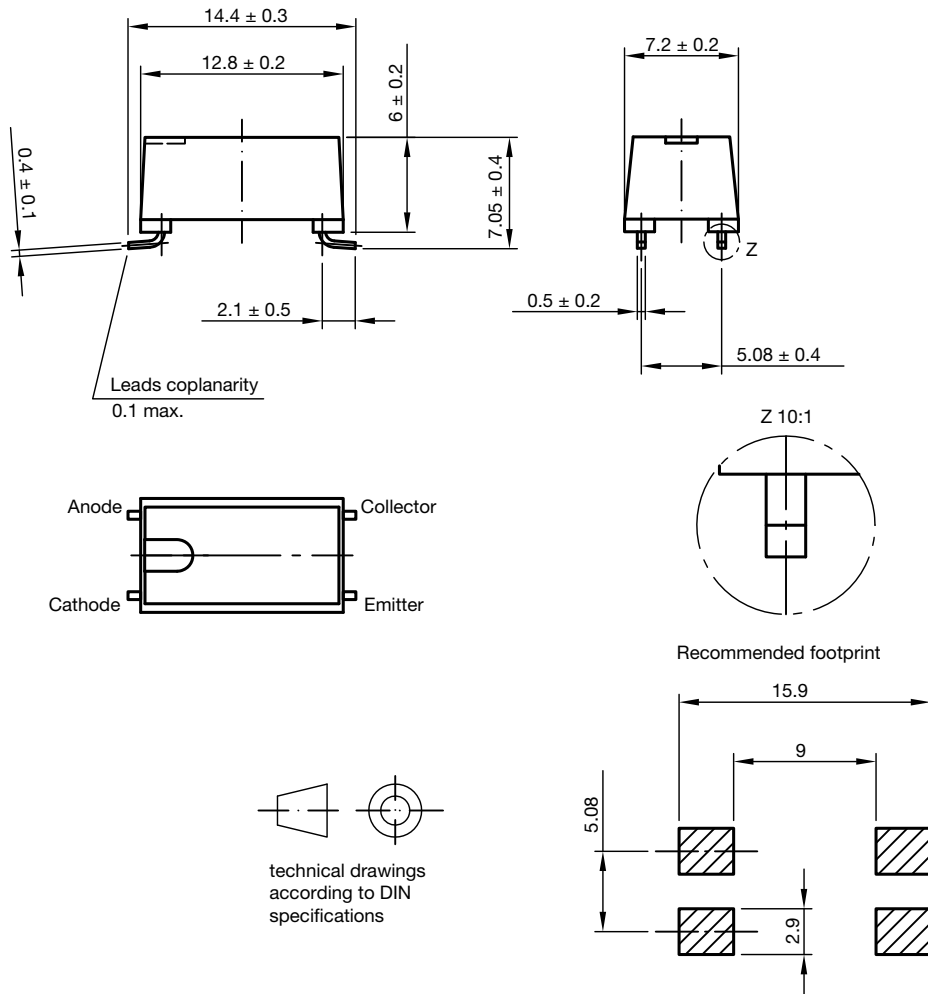

Fig. 17 - Switching Time vs. Load Resistance



PACKAGE DIMENSIONS in millimeters **FOR CNY64A...ST**





PACKAGE DIMENSIONS in millimeters FOR CNY65A...ST

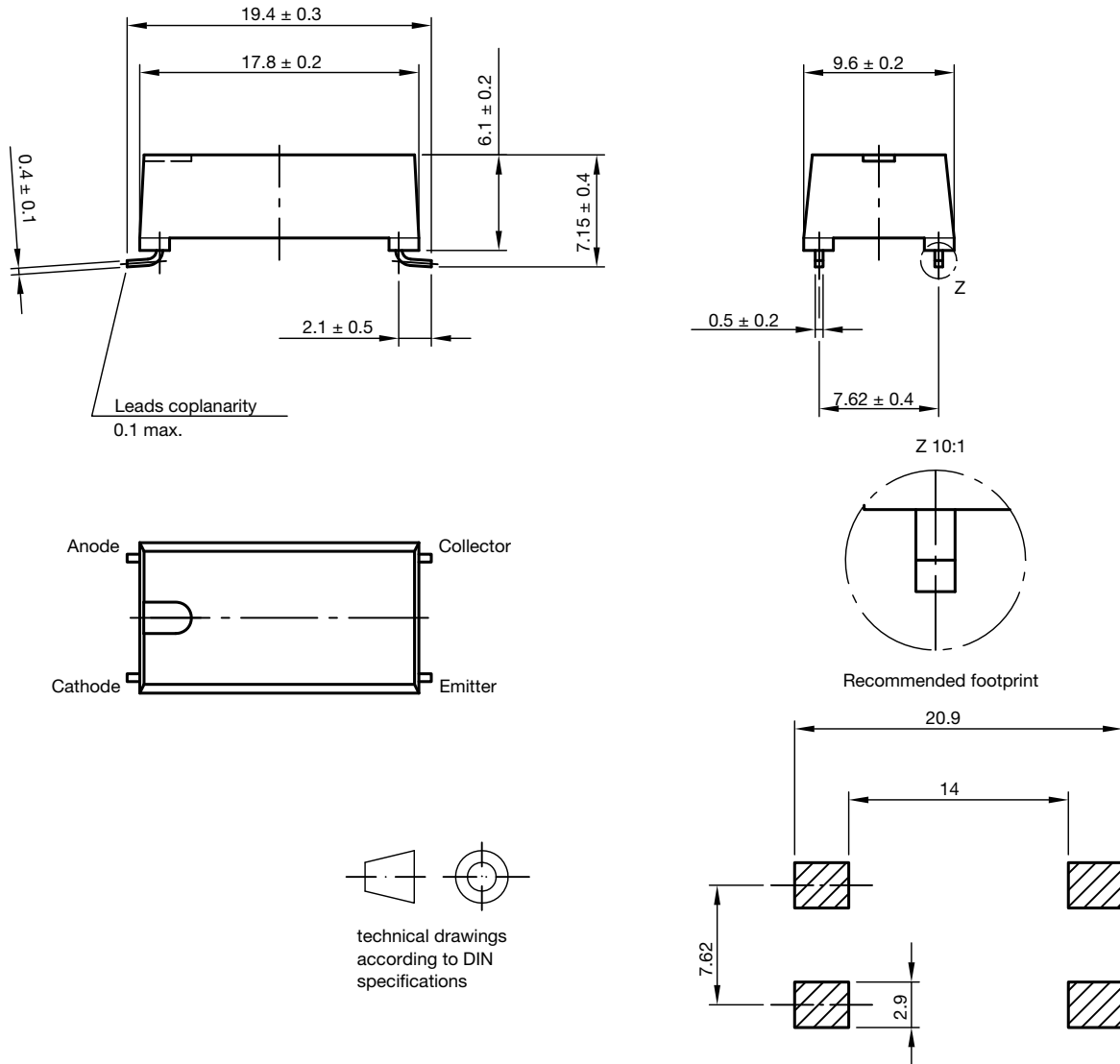

PACKAGE MARKING (Example)

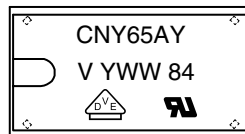

Note

- The "T" at the end of the product designation is not marked on the package



REEL DIMENSIONS in millimeters

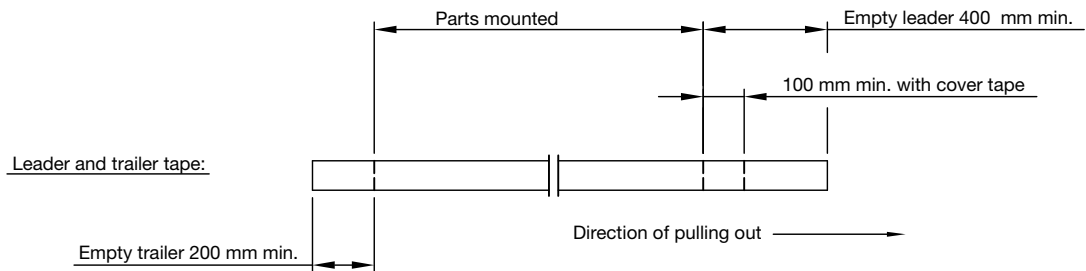
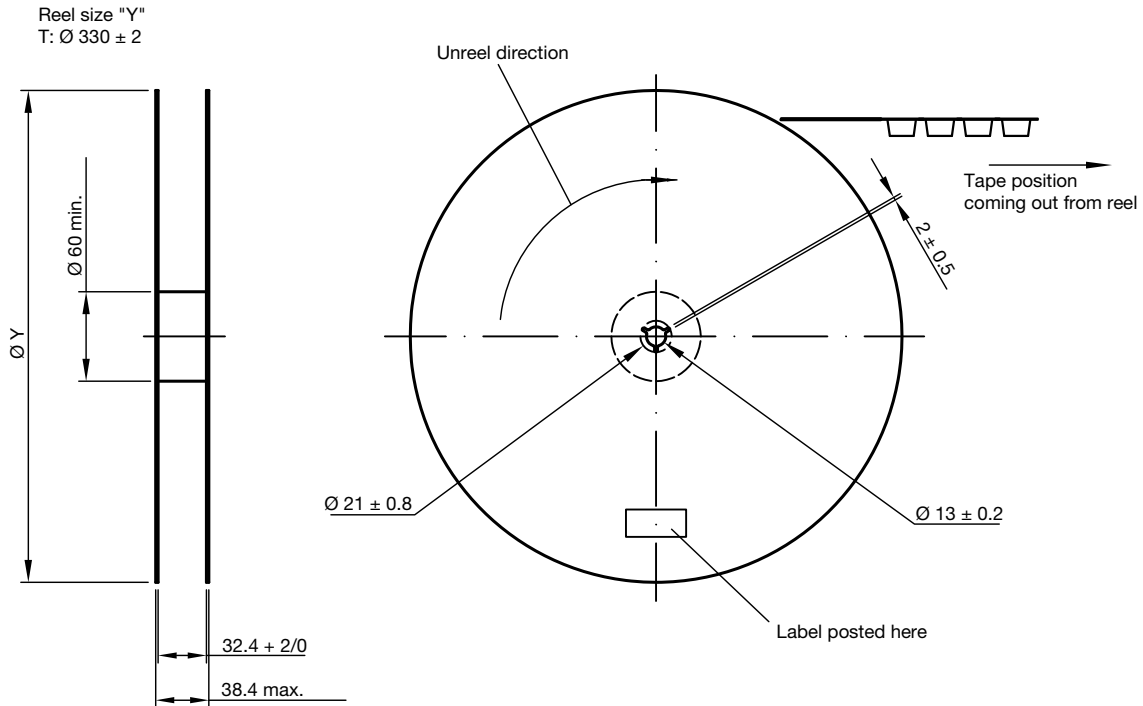

Not indicated tolerances ± 0.1

Drawing-No.: 9.800-5120.01-4
Issue: 1; 23.05.11

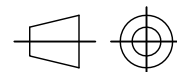

technical drawings according to DIN specifications

TAPE AND REEL INFORMATION			
TYPE	UNITS/REEL	REELS/BOX	UNITS/BOX
CNY64	400	2	800
CNY65	400	2	800



SOLDERING GUIDELINES

Soldering Condition

The CNY64AxST, CNY65AxST are lead (Pb)-free devices. They are suitable for reflow soldering. However due to large package size, the peak package body temperature should not go above 245 °C.

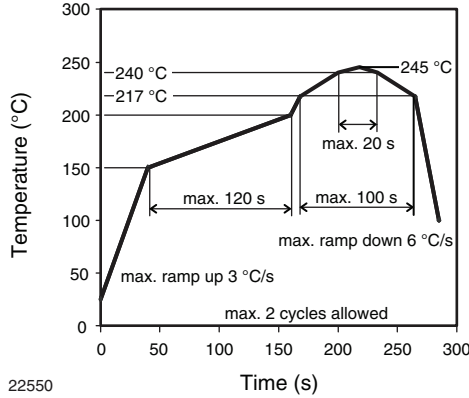

Drypack

Devices are packed in moisture barrier bags (MBB) to prevent moisture absorption during transportation and storage. Each bag contains a desiccant bag.

Floor Life

Floor life (time between soldering and removing from MBB) must not exceed the time indicated on MBB label:

Floor life: 72 h

Conditions: T_{amb} < 30 °C, RH < 60 %

Moisture sensitivity level 4, according to J-STD-020.

Drying

In case of moisture absorption devices should be baked before soldering according to the recommended conditions shown below

48 h at 125 °C ± 5 °C, RH < 5%

(Not suitable for tape and reel)

In case the floor time has not exceeded 10 days the units can be baked in tape and reel according to the following conditions

168 h at 60 °C ± 5 °C, RH < 5 %

(Not suitable, if the floor time was exceeded by more than 10 days, or the allowed factory condition is exceeded)



Disclaimer

ALL PRODUCT, PRODUCT SPECIFICATIONS AND DATA ARE SUBJECT TO CHANGE WITHOUT NOTICE TO IMPROVE RELIABILITY, FUNCTION OR DESIGN OR OTHERWISE.

Vishay Intertechnology, Inc., its affiliates, agents, and employees, and all persons acting on its or their behalf (collectively, "Vishay"), disclaim any and all liability for any errors, inaccuracies or incompleteness contained in any datasheet or in any other disclosure relating to any product.

Vishay makes no warranty, representation or guarantee regarding the suitability of the products for any particular purpose or the continuing production of any product. To the maximum extent permitted by applicable law, Vishay disclaims (i) any and all liability arising out of the application or use of any product, (ii) any and all liability, including without limitation special, consequential or incidental damages, and (iii) any and all implied warranties, including warranties of fitness for particular purpose, non-infringement and merchantability.

Statements regarding the suitability of products for certain types of applications are based on Vishay's knowledge of typical requirements that are often placed on Vishay products in generic applications. Such statements are not binding statements about the suitability of products for a particular application. It is the customer's responsibility to validate that a particular product with the properties described in the product specification is suitable for use in a particular application. Parameters provided in datasheets and / or specifications may vary in different applications and performance may vary over time. All operating parameters, including typical parameters, must be validated for each customer application by the customer's technical experts. Product specifications do not expand or otherwise modify Vishay's terms and conditions of purchase, including but not limited to the warranty expressed therein.

Hyperlinks included in this datasheet may direct users to third-party websites. These links are provided as a convenience and for informational purposes only. Inclusion of these hyperlinks does not constitute an endorsement or an approval by Vishay of any of the products, services or opinions of the corporation, organization or individual associated with the third-party website. Vishay disclaims any and all liability and bears no responsibility for the accuracy, legality or content of the third-party website or for that of subsequent links.

Vishay products are not designed for use in life-saving or life-sustaining applications or any application in which the failure of the Vishay product could result in personal injury or death unless specifically qualified in writing by Vishay. Customers using or selling Vishay products not expressly indicated for use in such applications do so at their own risk. Please contact authorized Vishay personnel to obtain written terms and conditions regarding products designed for such applications.

No license, express or implied, by estoppel or otherwise, to any intellectual property rights is granted by this document or by any conduct of Vishay. Product names and markings noted herein may be trademarks of their respective owners.

Looking for pricing, stock, or lifecycle information?

Click below to explore more details on WIN SOURCE:

 [View CNY64ABST on WIN SOURCE](#)

 [Vishay Information](#)

Optimize Your Supply Chain with WIN SOURCE Solutions

-  Global Sourcing Solution
-  Obsolete Management
-  Cost Control Management
-  Shortage Management
-  Alternative Solution
-  Excess Inventory Management