



**THE DATASHEET OF
AMCV-1206H-380-T**



SMD Multilayer Chip Varistor



AMCV-1206H Series

Request Samples



Check Inventory



3.2 x 1.6 x 1.05mm
RoHS/RoHS II Compliant
MSL Level = 1

Features

- SMD type, small size suitable for high density mounting
- Excellent clamping ratio and strong capability of voltage surge suppression
- Excellent solderability (Ni, Sn plating)

Applications

- Transient voltage protection and voltage surge suppression for LED lighting
- Suitable for LCD-TV, STB, Switch, Router, PLC, Security System, smart meters, mobile phones
- Suppressing Induced / switching over-voltage caused by lightning and power
- Protecting DC-DC Module, I/O ports, IC driver

Electrical Specifications

Part Number	Max. Working Voltage		Varistor Voltage	Max. Clamping Voltage		Rated Single Pulse Transient		
	DC	AC RMS		8/20 μ s	ESD	Energy 10/1000 μ s	Peak Current 8/20 μ s	Nominal Current 8/20 μ s
Test Condition	<20 μ A		@1mA DC					
Units	Volts	Volts	Volts	Volts	Amps	Joules	Amps	Amps
Symbol	VWDC	VWAC	VB	VC	IC	E _T	I _P	I _N
AMCV-1206H-090	9	6.4	14.0 [12.0-16.0]	30	5.0	0.5	500	300
AMCV-1206H-180	18	12.7	25.0 [22.0-28.0]	45	5.0	0.5	500	300
AMCV-1206H-300	30	21.3	42.0 [37.0-46.0]	70	5.0	0.8	500	300
AMCV-1206H-380	38	30.0	50.0 [46.0-54.0]	80	5.0	1.0	500	300
AMCV-1206H-480	48	34.1	60.0 [54.0-67.0]	110	5.0	1.2	500	300
AMCV-1206H-560	56	40.0	68.0 [61.0-75.0]	125	5.0	1.2	500	300
AMCV-1206H-600	60	46.0	76.0 [69.0-83.0]	130	5.0	1.2	500	300
AMCV-1206H-650	65	50.0	82.0 [73.0-91.0]	135	5.0	1.2	500	300
AMCV-1206H-850	85	60.0	100.0 [90.0-110.0]	165	5.0	1.2	400	250
AMCV-1206H-101	100	75.0	120.0 [108.0-132.0]	200	5.0	1.2	400	250

Unless otherwise specified, the standard atmospheric conditions for measurement/test as:

- Ambient Temperature: 20 \pm 15 $^{\circ}$ C
- Relative Humidity: 65 \pm 20%
- Air Pressure: 86 kPa to 106 kPa



12117 Bee Caves Rd Bldg-3, Ste 200
Bee Cave, TX 78738
Phone: 512-371-6159 Fax: 512-351-8858
For terms and conditions of sales, please visit:
www.abracon.com

REVISION C : 3/27/2025

ABRACON IS
ISO9001-2015
CERTIFIED

SMD Multilayer Chip Varistor



AMCV-1206H Series

Request Samples



Check Inventory



3.2 x 1.6 x 1.05mm
RoHS/RoHS II Compliant
 MSL Level = 1

Items	Test Methods and Remarks
Varistor Voltage at 1mA DC (V_B)	Measuring current: 1mA DC Duration: 0.2 to 2 sec
Capacitance (C)	Measure source: 1.0 V_{RMS} Test frequency: 1kHz.
Clamping Voltage (V_C)	Measuring source: 8/20us waveform

Operating Temperature: -55°C ~ +125°C.

Storage Condition: -10°C ~ +40°C (with packaging) and R.H. 70 % max.

AMCV-1206H Series is RoHS Compliant and Pb free.

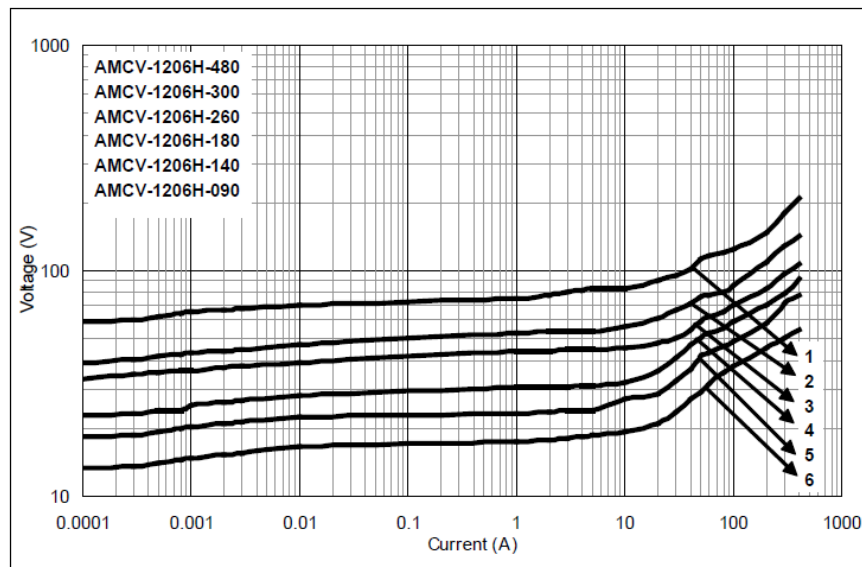

Part Identification

AMCV-1206H- [] - []

Voltage Code

Please refer to the table above

Packaging

T: Tape and Reel
(refer to packaging section)



12117 Bee Caves Rd Bldg-3, Ste 200
 Bee Cave, TX 78738
 Phone: 512-371-6159 Fax: 512-351-8858
 For terms and conditions of sales, please visit:
www.abracon.com

REVISION C : 3/27/2025

ABRACON IS
 ISO9001-2015
 CERTIFIED

SMD Multilayer Chip Varistor



AMCV-1206H Series

Request Samples



Check Inventory



3.2 x 1.6 x 1.05mm
RoHS/RoHS II Compliant
MSL Level = 1

Mechanical Specifications

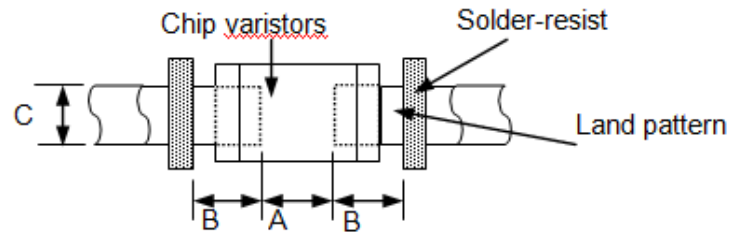
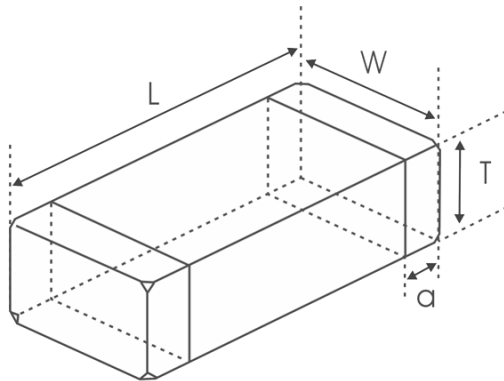

Series	L	W	T	a	A	B	C
AMCV-1206H	3.2±0.2	1.6±0.2	2.0 Max.	0.25~0.75	1.8~2.5	1.0~1.5	1.2~2.0

Dimensions: mm

Materials

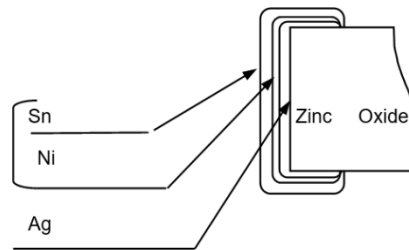
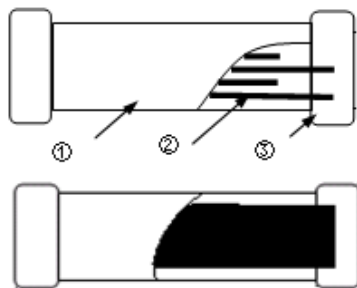

	Part Name	Material
1	Base Material	ZnO
2	Internal Conductor	Ag-Pd
3	Terminal Electrode	Ag (Inner layer) Ni-Sn (Outer layer)



12117 Bee Caves Rd Bldg-3, Ste 200
 Bee Cave, TX 78738
 Phone: 512-371-6159 Fax: 512-351-8858
 For terms and conditions of sales, please visit:
www.abracon.com

REVISION C : 3/27/2025

ABRACON IS
 ISO9001-2015
 CERTIFIED

SMD Multilayer Chip Varistor

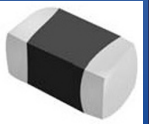

AMCV-1206H Series

Request Samples



Check Inventory



3.2 x 1.6 x 1.05mm
RoHS/RoHS II Compliant
MSL Level = 1

Reflow Profile

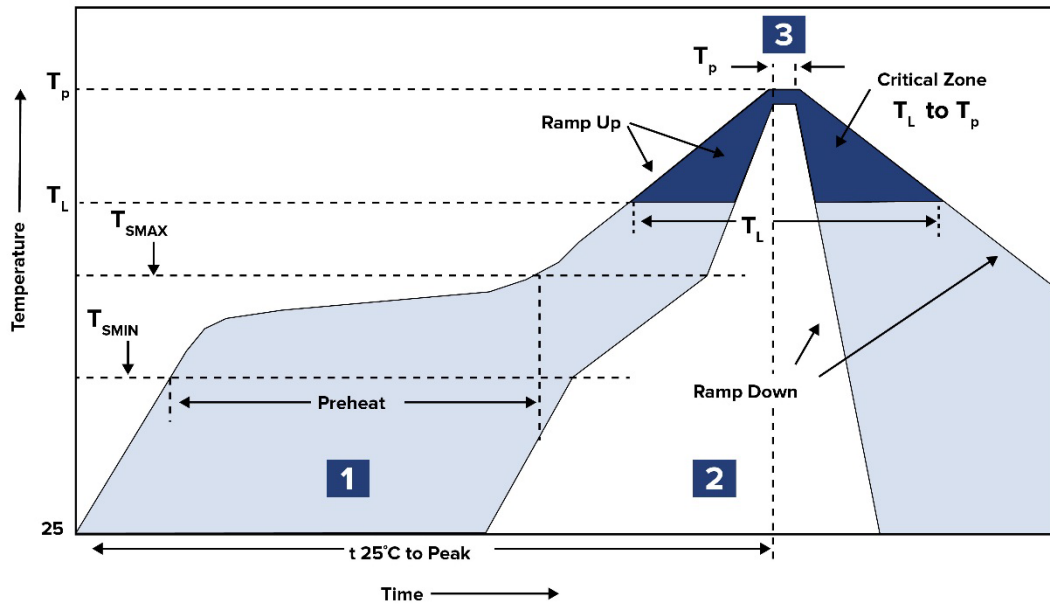

Zone	Description	Temperature	Times
1	Preheat	$T_{SMIN} \sim T_{SMAX}$ 150°C ~ 200°C	60 ~ 120 sec.
2	Reflow	T_L $\geq 217^\circ C$	60 ~ 90 sec.
3	Peak heat	T_p 260°C Max.	10 sec. MAX

Ref Paste: Sn/3.0Ag/0.5Cu (Lead-Free)

Max ramp up rate: 3°C/Sec

Max ramp down rate: 6°C/Sec

SMD Multilayer Chip Varistor

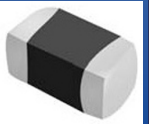

AMCV-1206H Series

Request Samples



Check Inventory



3.2 x 1.6 x 1.05mm
RoHS/RoHS II Compliant
MSL Level = 1

Packaging

Tape & Reel: 3000 pcs/reel (Part number: AMCV-1206H-090)
2000 pcs/reel (Part number: All others)

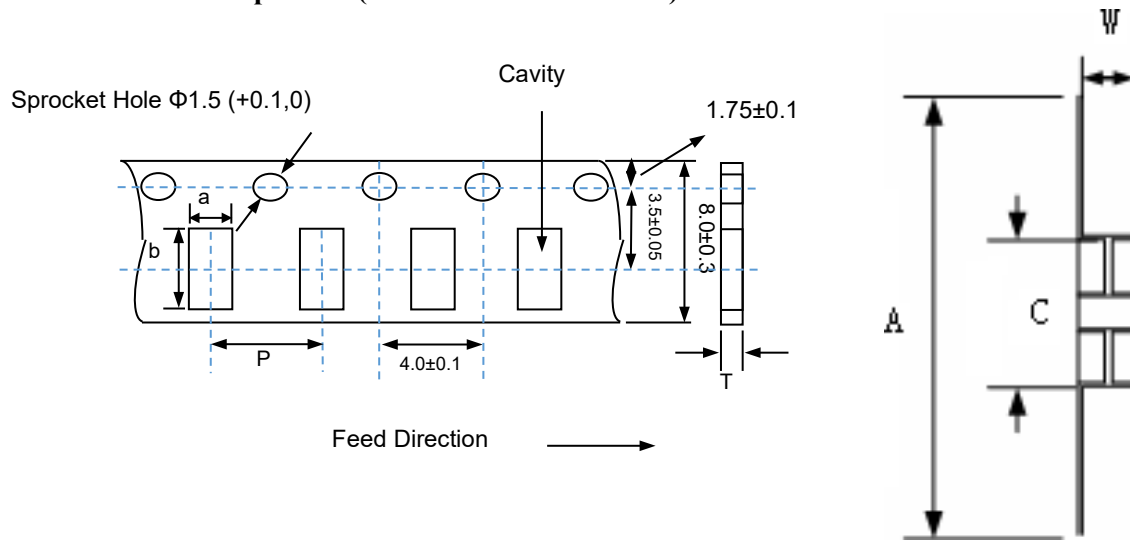

a	b	P	T (max)	A	W	C
2.1	3.9	4.0	1.10±0.1	330	12.4 +2.0/0	100

Dimensions: mm

ATTENTION: Abracon LLC's products are Commercial-Off-The-Shelf (COTS), which are designed, intended and validated for use in commercial, industrial and automotive applications. The customer is responsible for testing and verifying the performance of an Abracon solution to meet their system-level requirements.



12117 Bee Caves Rd Bldg-3, Ste 200
 Bee Cave, TX 78738
 Phone: 512-371-6159 Fax: 512-351-8858
 For terms and conditions of sales, please visit:
www.abracon.com

REVISION C : 3/27/2025

ABRACON IS
 ISO9001-2015
 CERTIFIED

Looking for pricing, stock, or lifecycle information?

Click below to explore more details on WIN SOURCE:

 [View AMCV-1206H-380-T on WIN SOURCE](#)

 [Abracon LLC Information](#)

Optimize Your Supply Chain with WIN SOURCE Solutions

-  Global Sourcing Solution
-  Obsolete Management
-  Cost Control Management
-  Shortage Management
-  Alternative Solution
-  Excess Inventory Management