

1. Features

- Antenna for 2.4GHz applications
- Bluetooth, Wi-Fi, ZigBee, ISM.
- Maintains high performance on device: DFI (Designed for Integration)
- Ultra-low profile innovative design.
- SMD mounting
- Supplied on Tape and Reel
- Automotive temperature rating.

2. Description

Serica is intended for use with 2.4GHz applications. The antenna only requires a small ground plane. It is ideal for single and MIMO antenna systems. This product specification shows the performance of the antenna over the frequency range 2.4 – 2.5GHz.

3. Applications

- Wearable devices
- Medical equipment
- Tablets
- Network Devices
- MIMO Systems
- IP Cameras
- Access Points

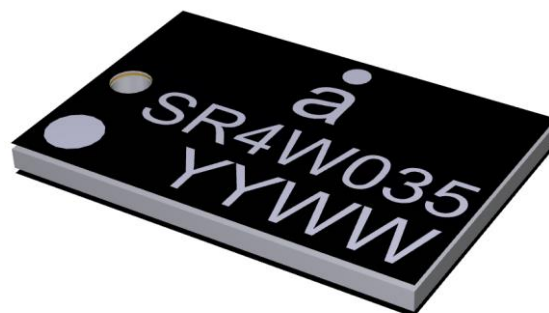

4. Part Number

Serica: SR4W035



5. General Data

Product name	Serica
Part Number	SR4W035
Frequency	2.4 – 2.5 (GHz)
Polarization	Linear
Operating temperature	-40°C to 140°C
Environmental Condition Test	ISO16750-4 5.1.1.1/5.1.2.1/5.3.2
Impedance with matching	50 Ω
Weight	<1g
Antenna type	SMD
Dimensions	6.0 x 4.0 x 0.4 (mm)

6. RF Characteristics

	2400 - 2500 MHz	Conditions
Peak gain	3.50dBi	All data measured on Antenna's evaluation PCB Part No. SR4W035-EVB-1
Average gain (Linear)	-1.50dBi	
Average efficiency	>65%	
Maximum return loss	-10.0dB	
Maximum VSWR	1.85:1	

7. RF Performance

7.1 Return Loss

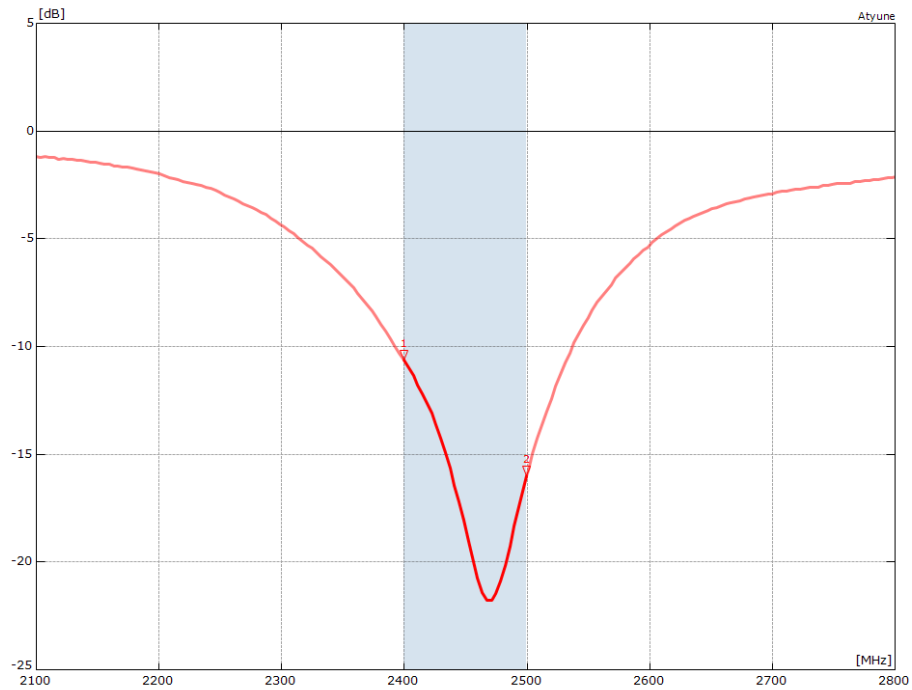

7.2 VSWR

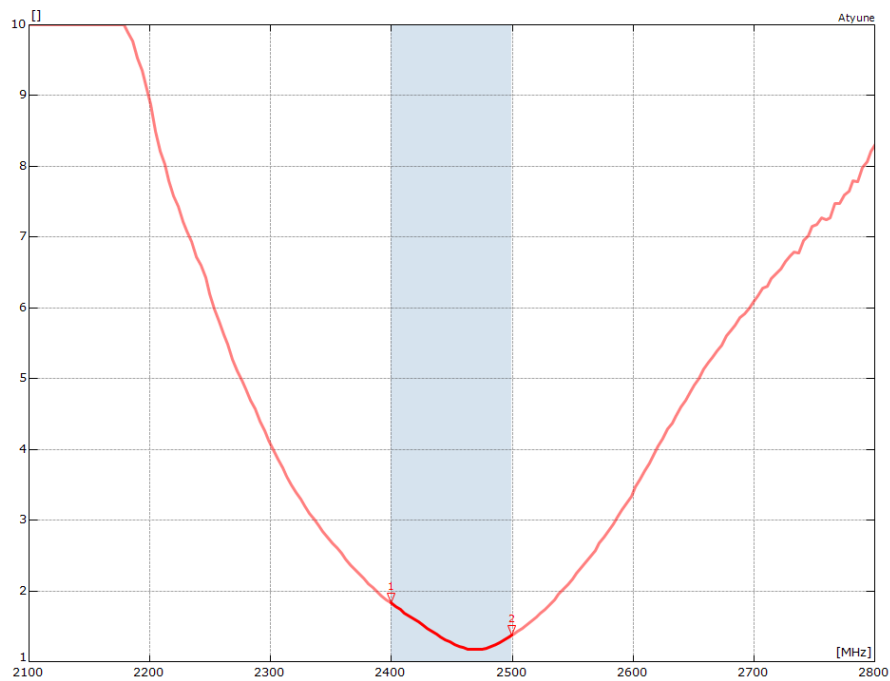

7.3 Antenna pattern

2400 MHz – 2500 MHz

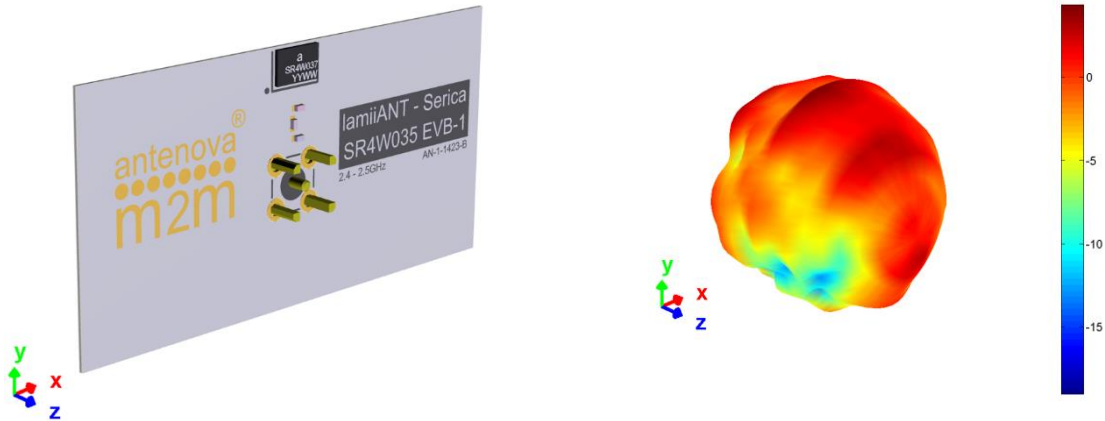

3D pattern at 2.45 GHz

Drag to rotate pattern and PCB by using Adobe Reader
(Click to Activate)

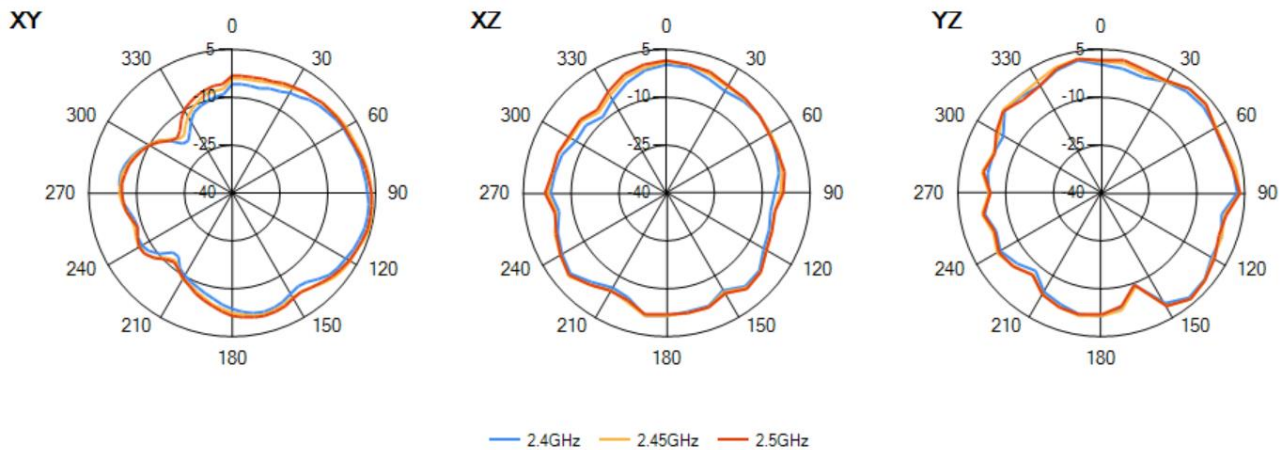

8. Antenna Dimensions

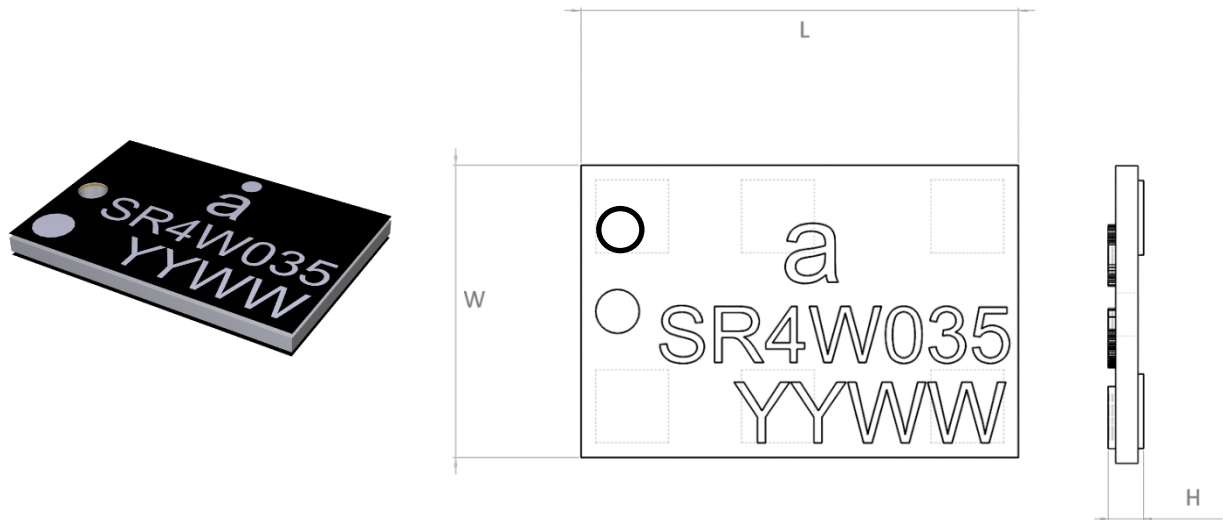

L	W	H
Length	Width	Height
6.0 ±0.1	4.0 ±0.1	0.4 +0.1 -0.0

All Dimensions in (mm)

Bottom Side Dimensions

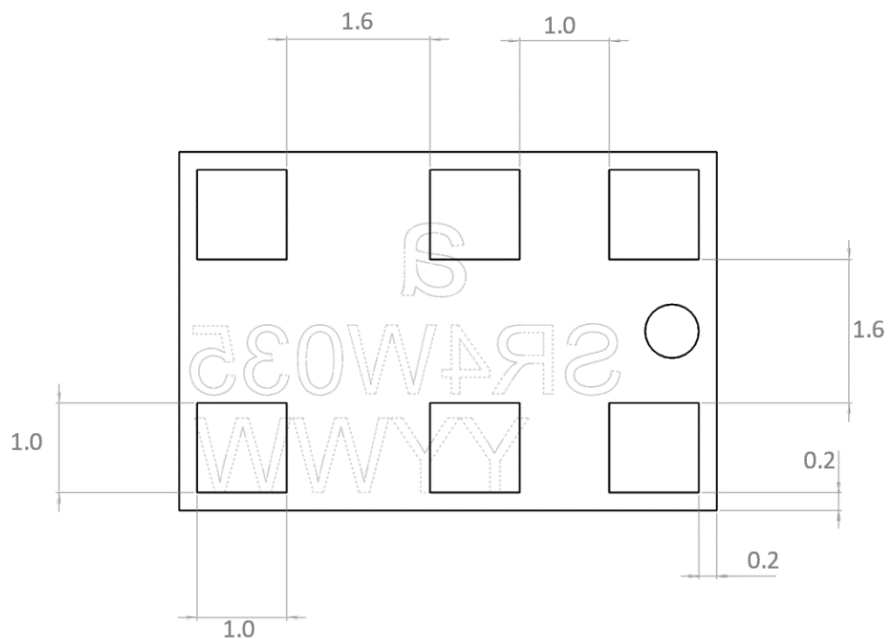

9. Schematic symbol and Pin definition

The circuit symbol for the antenna is shown below. The antenna has 6 pins with only two as functional. All other pins are for mechanical strength.

Pin	Description
2	Feed
3,4,6	Return/GND
1,5	Not used (Mechanical only)

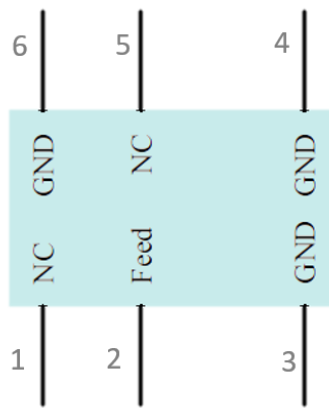

Serica Schematic Symbol

10. Antenna footprint

The recommended host PCB footprint is below.

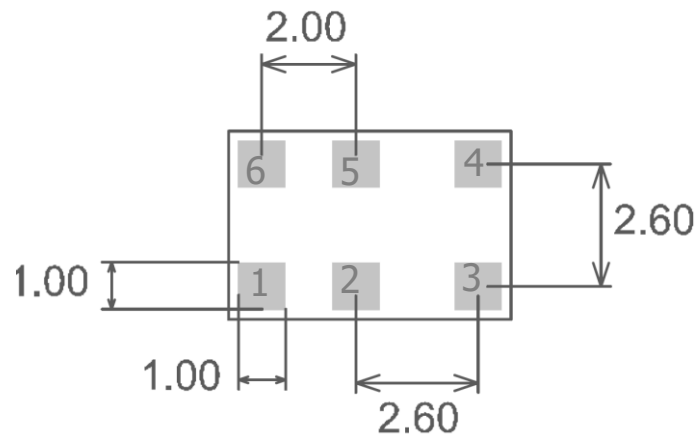

6 copper pads all 1.0 x 1.0 (mm)

11. Electrical Interface

11.1 Transmission Line

All transmission lines should be designed to have a characteristic impedance of 50Ω.

- The length of the transmission lines should be kept to a minimum.
- Any other parts of the RF system like transceivers, power amplifiers, etc, should also be designed to have an impedance of 50 Ω.

Once the material for the PCB has been chosen (PCB thickness and dielectric constant), a coplanar transmission line can easily be designed using any of the commercial software packages for transmission line design. For the chosen PCB thickness, copper thickness and substrate dielectric constant, the program will calculate the appropriate transmission line width and gaps on either side of the track, so the characteristic impedance of the co-planar transmission is 50 Ω.

11.2 Matching Circuit

The antenna requires a matching circuit that must be optimized for each product. The matching circuit will require up to five components and the following circuit should be designed into the host PCB. Not all components may be required but should be included as a precaution. The matching network must be placed close to the antenna feed to ensure it is more effective in tuning the antenna.

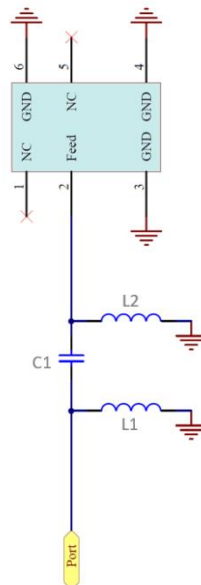

12. Antenna Integration Guide

12.1 Antenna Placement

Whichever size host PCB is used, the antenna should ideally be placed on the host PCB's longest edge at the centre.

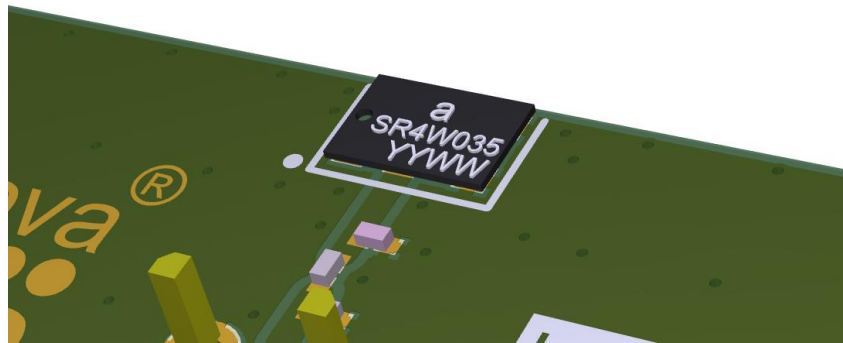

Where the centre is not a viable option, the antenna can be placed offset on the PCB to within the limits shown below. A minimum of 6mm from either PCB edge should be observed. Where possible this distance should be greater than 6mm.

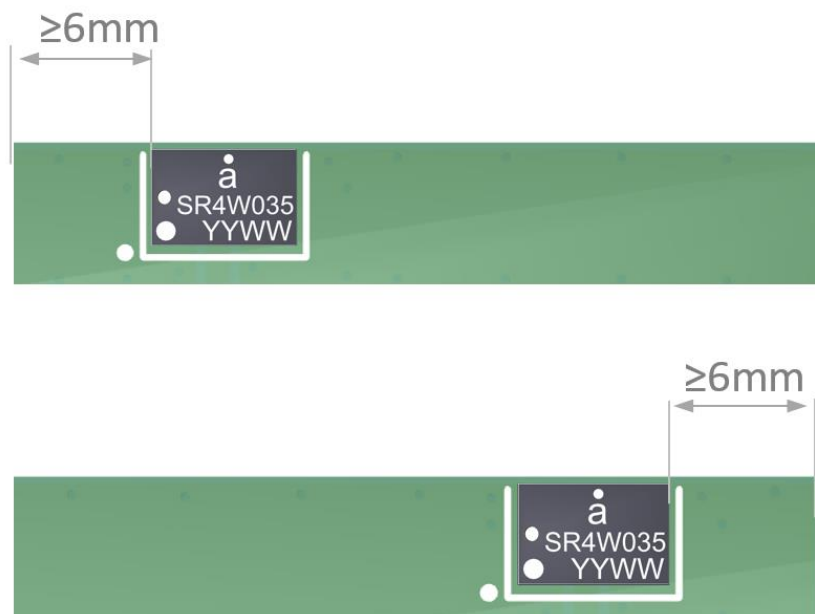

12.2 Host PCB Layout

The footprint and clearance of the host PCB must meet the antenna specification. An example of the PCB layout, below, shows the antenna footprint with clearance. Pins 3, 4 and 6 (GND) are shown directly connecting to the GND with the shortest route. The feed (Pin 2) connects to the matching circuit close to the antenna.

Example host layout

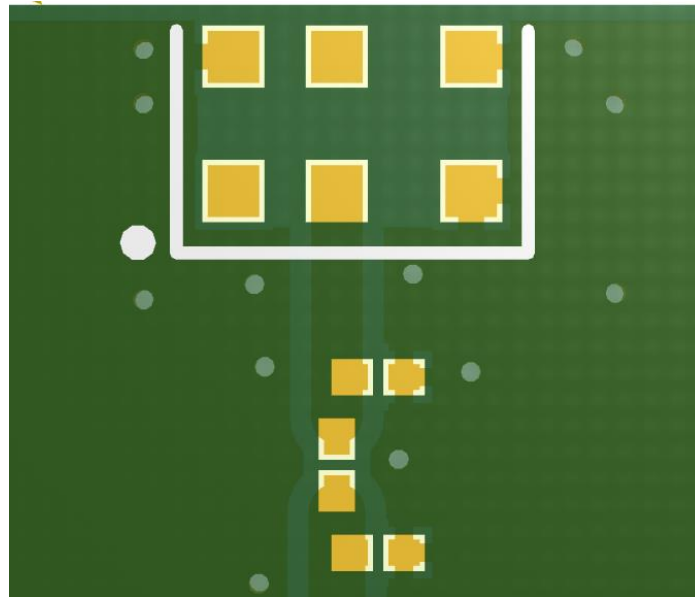

12.3 Host PCB Clearance

The diagram below shows the antenna footprint and clearance through all layers on the PCB. Only the antenna pads and connections to feed and GND are present within this clearance area. The clearance area required is 6.0 x 4.0 (mm).

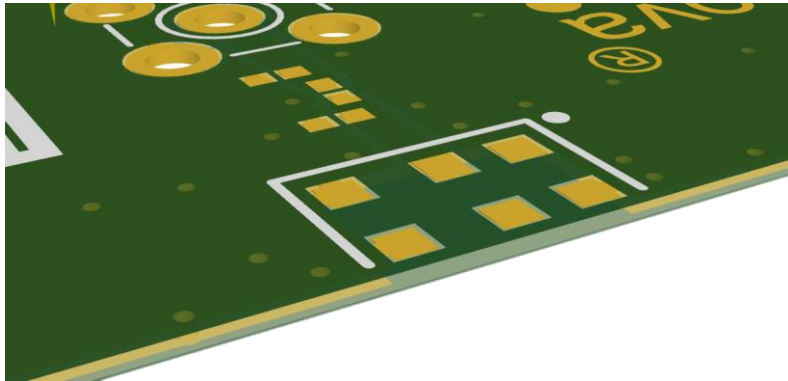

The clear-out area is simply defined as the same size as the antenna. No additional clearance is required.

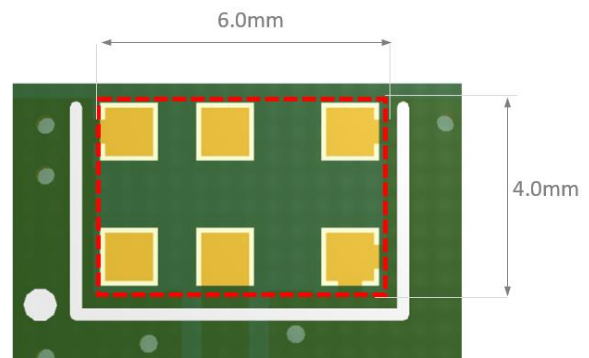
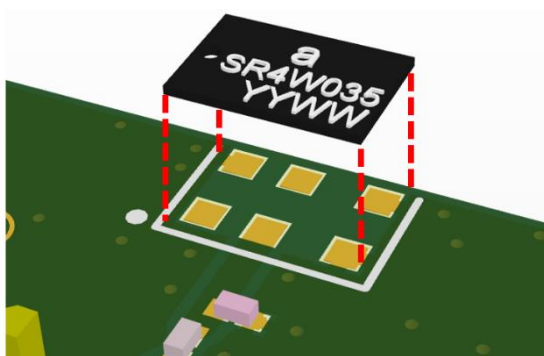

----- Clearance area

13. Reference Board

The reference board has been designed for the purpose of evaluating SR4W035 and includes an SMA female connector.

SR4W035-EVB-1 Evaluation Board



To order a reference board please see www.antenova.com

13.1 Reference Board Matching Circuit

The reference board has been designed for the purposes of evaluating SR4W035 and includes an SMA female connector.

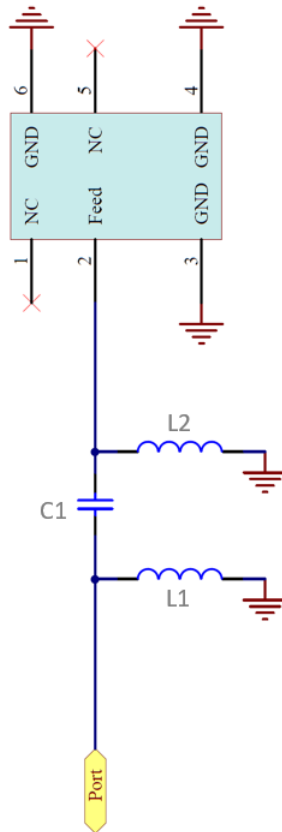

Designator	Type	Value	Description
L1	Not Fitted	Not Fitted	Not Fitted
L2	Inductor	2.2nH	Murata LQG15HN series or equivalent
C1	Capacitor	1.5pF	Murata GRM15HS series or equivalent

14. Soldering

This antenna is suitable for lead free soldering. The reflow profile should be adjusted to suit the device, oven and solder paste, while observing the following conditions:

- The maximum temperature should not exceed 240 °C.
- However for lead free soldering, a maximum temperature of 255 °C for no more than 20 seconds is permitted.
- The antenna should not be exposed to temperatures exceeding 120 °C more than 3 times during the soldering process.

15. Hazardous Material Regulation Conformance

The antenna has been tested to conform to RoHS requirements. A certificate of conformance is available from Antenova's website.

16. Packaging

16.1 Optimal Storage Conditions

Temperature	-10°C to 40°C
Humidity	Less than 75% RH
Shelf life	24 Months
Storage place	Away from corrosive gas and direct sunlight
Packaging	Reels should be stored in unopened sealed manufacturer's plastic packaging.

Note: Storage of open reels of antennas is not recommended due to possible oxidization of pads on antennas. If short term storage is necessary, then it is highly recommended that the bag containing the antenna reel is re-sealed and stored in like storage conditions as in above table.

16.2 Tape Characteristics

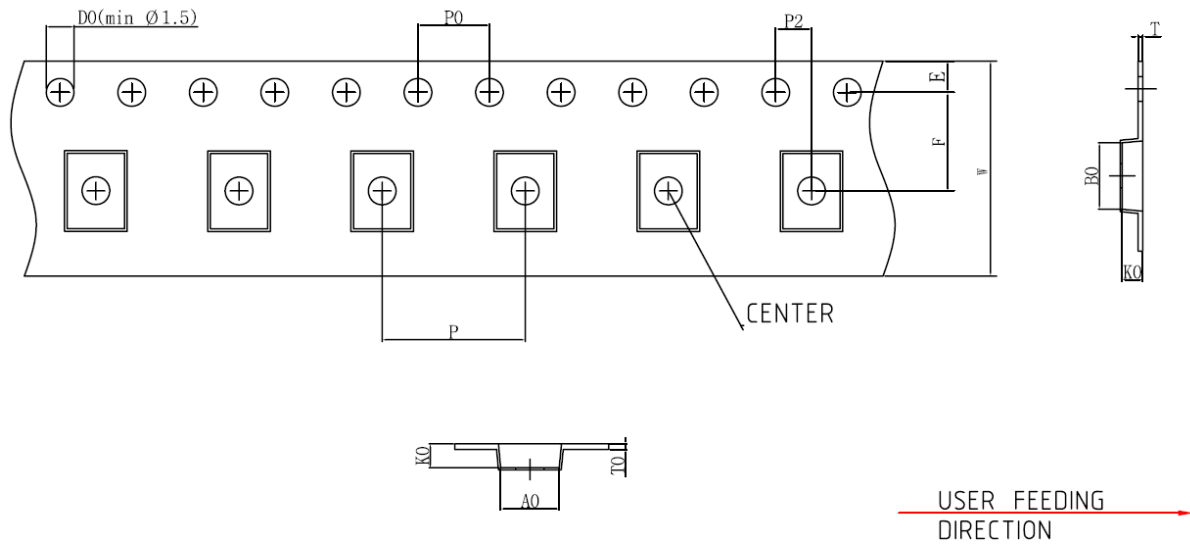

Ko	Ao	Bo	P0	P1	P2
0.95 ± 0.1	4.20 ± 0.1	6.20 ± 0.1	4.00 ± 0.1	8.00 ± 0.1	2.00 ± 0.1

E	F	W
1.75 ± 0.1	7.50 ± 0.15	12.00 ± 0.3

Dimensions in mm

Notes:

- 1) 10 sprocket hole pitch cumulative tolerance ±0.2
- 2) Camber not to exceed 1mm in 100mm
- 3) Ao and Bo measured on a plane 0.1mm above the bottom of the pocket
- 4) Ko measured from a plane on the inside bottom of the pocket to the top surface of the carrier

16.3 Reel Dimensions

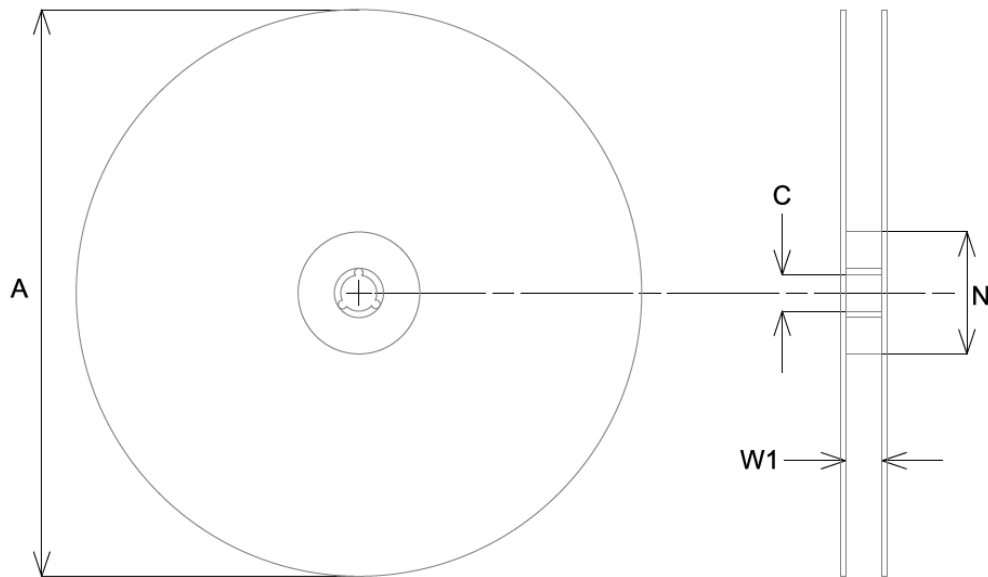

A	C	N	W1
178.0 ± 2.0	13.50 ± 0.5	60.0 ± 0.2	13.0 ± 0.3

All dimensions in mm

16.4 Box Dimensions

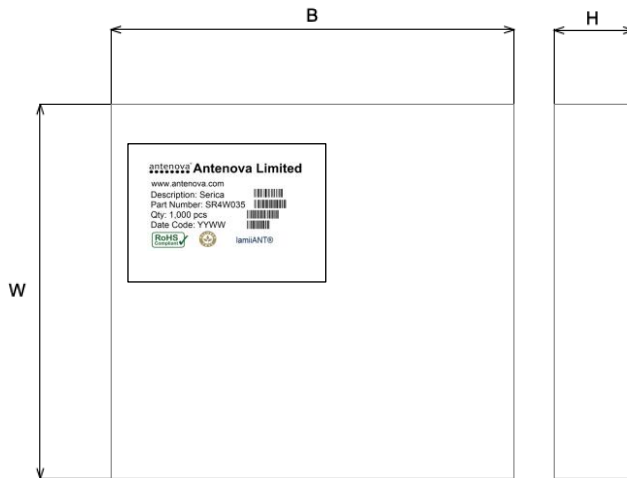

Width (W)	Breadth (B)	Thickness (H)
203mm	188mm	40mm

16.5 Bag Properties

Reels are supplied in protective plastic packaging.

16.6 Reel Label Information



Quality statements

Antenova's products conform to REACH and RoHS legislation. For our statements regarding these and other quality standards, please see www.antenova.com.



Antenna design, integration and test resources

Product designers – the details contained in this datasheet will help you to complete your embedded antenna design. Please follow our technical advice carefully to obtain optimum antenna performance.

It is our goal that every customer will create a high performing wireless product using Antenova's antennas. You will find a wealth of design resources, calculators and case studies to aid your design at our website.

Antenova's design laboratories are equipped with the latest antenna design tools and test chambers. We provide antenna design, test and technical integration services to help you complete your design and obtain certifications.

If you cannot find the antenna you require in our product range, please contact us to discuss creating a bespoke antenna to meet your requirement exactly.

Contacts

Join our online antenna design community: ask.antenova.com

Order antenna samples and evaluation boards at: www.antenova.com

Request a quotation for antennas by volume: sales@antenova.com

Global Headquarters:



**Antenova Ltd, 2nd Floor Titan Court, 3 Bishop Square,
Hatfield, AL10 9NA +44 (0) 1223 810600**

Copyright® Antenova Ltd. All Rights Reserved. Antenova®, gigaNOVA®, RADIONOVA®, the Antenova product family names and the Antenova logos are trademarks and/or registered trademarks of Antenova Ltd. Any other names and/or trademarks belong to their respective companies. The materials provided herein are believed to be reliable and correct at the time of printing. Antenova does not warrant the accuracy or completeness of the information, text, graphics or other items contained within this information. Antenova further assumes no responsibility for the use of this information, and all such information shall be entirely at the user's risk.





Antennas for Wireless Applications

Looking for pricing, stock, or lifecycle information?

Click below to explore more details on WIN SOURCE:

-  [View SR4W035 on WIN SOURCE](#)
-  [Antenova Information](#)

Optimize Your Supply Chain with WIN SOURCE Solutions

-  Global Sourcing Solution
-  Obsolete Management
-  Cost Control Management
-  Shortage Management
-  Alternative Solution
-  Excess Inventory Management