



**THE DATASHEET OF
ECS-160-20-46X**



The HC-46X is the miniature low profile resistance weld type Thru Hole quartz crystal. Reduces footprint of HC-49USX by 50%.

HC-46X QUARTZ CRYSTAL

Request a Sample

HC-46X QUARTZ CRYSTAL



- Cost Effective
- Low Profile
- Pb Free/RoHS Compliant

OPERATING CONDITIONS / ELECTRICAL CHARACTERISTICS

PARAMETERS	CONDITIONS	HC-46X			UNITS
		MIN	TYP	MAX	
Frequency	Fo	12.000		40.000	MHz
Mode of Oscillation	Fundamental				
Frequency Tolerance*	@ +25°C			± 30	ppm
Frequency Stability*	-10 ~ +70°C			± 50	ppm
Shunt Capacitance	Co			7	pF
Load Capacitance	Specify in P/N	10	20	Series	pF
Drive Level	DL			100	μW
Operating Temperature*	Topr	-10		+70	°C
Storage Temperature	Tstg	-40		+85	°C
Aging (First Year)	@ +25°C ±3°C			±5	ppm

DIMENSIONS (mm)

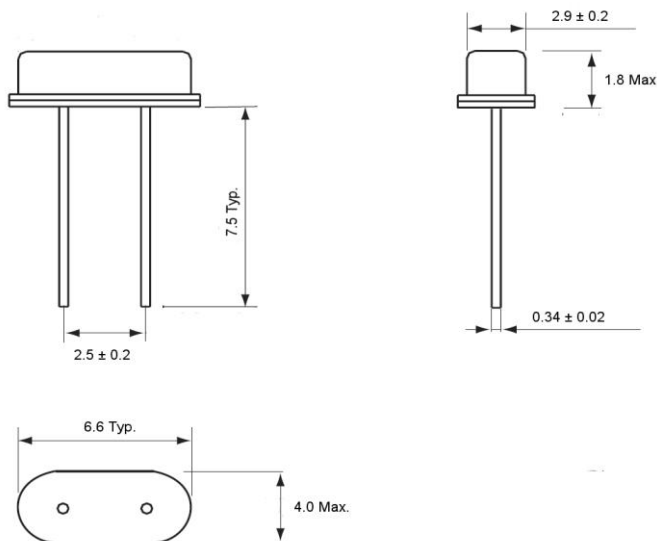

Frequency (MHz)	ESR Ω Max.
12.000 ~ 15.999	60
16.000 ~ 29.999	50
30.000 ~ 40.000	40

Figure 1) Side, Bottom, and End

PART NUMBERING GUIDE: Example ECS-200-20-46X

ECS - FREQUENCY ABBREVIATION	LOAD CAPACITANCE	PACKAGE	AVAILABLE OPTIONS			PACKAGING	
			Tolerance	Stability	Temp Range		
ECS	200 = 20.000 MHz See P/N Guide	20 = 20 pF S = Series	46X = HC-46X	Blank = Std A = ± 25 ppm J = ± 20 ppm R = ± 15 ppm C = ± 10 ppm	Blank = Std D = ± 100 ppm E = ± 50 ppm G = ± 30 ppm H = ± 25 ppm T = ± 20 ppm † W = ± 15 ppm † K = ± 10 ppm †	Blank = Std L = -10 ~ +70°C M = -20 ~ +70°C Y = -30 ~ +85°C N = -40 ~ +85°C P = -40 ~ +105°C S = -40 ~ +125°C U = -55 ~ +125°C	Bulk

* Specify available options in P/N.

† Contact ECS for availability over extended temp range.

Rev.2017

SOLDER PROFILE	
Peak solder Temp	+260°C Max 10 sec Max.
	2 Cycles Max.
	MSL 1, Lead Finish Sn/Cu Matte

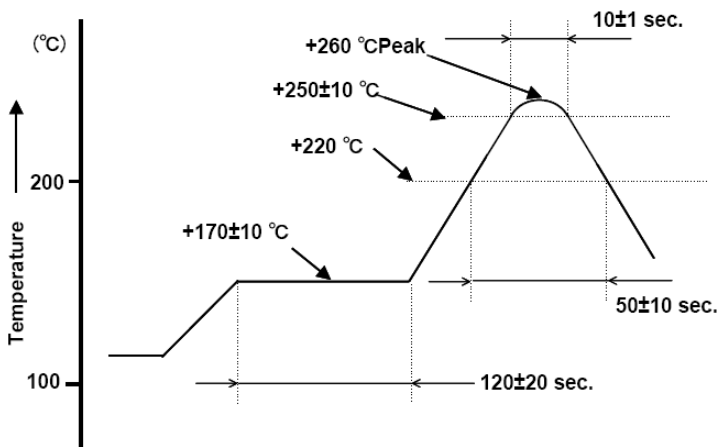

Figure 1) Suggested Solder Profile

DEVELOPED FREQUENCIES	
Abbreviation	Frequency (MHZ)
120	12.000
122.8	12.288
130	13.000
135.6	13.560
143	14.31818
147.4	14.7456
160	16.000
184	18.432
196.6	19.6608
200	20.000
245.7	24.576
250	25.000
270	27.000
286.3	28.63636
300	30.000
330	33.000
400	40.000

Looking for pricing, stock, or lifecycle information?

Click below to explore more details on WIN SOURCE:

 [View ECS-160-20-46X on WIN SOURCE](#)

 [ECS Inc. Information](#)

Optimize Your Supply Chain with WIN SOURCE Solutions

-  Global Sourcing Solution
-  Obsolete Management
-  Cost Control Management
-  Shortage Management
-  Alternative Solution
-  Excess Inventory Management