





## 500ksp/s, Low-Power, Serial 12-/10-/8-Bit ADCs

MAX11661-MAX11666

### General Description

The MAX11661-MAX11666 are 12-/10-/8-bit, compact, low-power, successive approximation analog-to-digital converters (ADCs). These high-performance ADCs include a high-dynamic range sample-and-hold and a high-speed serial interface. These ADCs accept a full-scale input from 0V to the power supply or to the reference voltage.

The MAX11662/MAX11664/MAX11666 feature dual, single-ended analog inputs connected to the ADC core using a 2:1 MUX. The devices also include a separate supply input for data interface and a dedicated input for reference voltage. In contrast, the single-channel devices generate the reference voltage internally from the power supply.

These ADCs operate from a 2.2V to 3.6V supply and consume only 3.3mW. The devices include full power-down mode and fast wake-up for optimal power management and a high-speed 3-wire serial interface. The 3-wire serial interface directly connects to SPI, QSPI™, and MICROWIRE® devices without external logic.

Excellent dynamic performance, low voltage, low power, ease of use, and small package size make these converters ideal for portable battery-powered data-acquisition applications, and for other applications that demand low-power consumption and minimal space.

These ADCs are available in a 10-pin μMAX® package, and a 6-pin SOT23 package. These devices operate over the -40°C to +125°C temperature range.

### Features

- ◆ 500ksp/s Conversion Rate, No Pipeline Delay
- ◆ 12-/10-/8-Bit Resolution
- ◆ 1-/2-Channel, Single-Ended Analog Inputs
- ◆ Low-Noise 73dB SNR
- ◆ Variable I/O: 1.5V to 3.6V (Dual-Channel Only)  
Allows the Serial Interface to Connect Directly to 1.5V, 1.8V, 2.5V, or 3V Digital Systems
- ◆ 2.2V to 3.6V Supply Voltage
- ◆ Low Power  
3.3mW  
Very Low Power Consumption at 8μA/ksp/s
- ◆ External Reference Input (Dual-Channel Devices Only)
- ◆ 1.3μA Power-Down Current
- ◆ SPI-/QSPI-/MICROWIRE-Compatible Serial Interface
- ◆ 10-Pin, 3mm x 5mm μMAX Package
- ◆ 6-Pin, 2.8mm x 2.9mm SOT23 Package
- ◆ Wide -40°C to +125°C Operation

### Applications

Data Acquisition  
Portable Data Logging  
Medical Instrumentation  
Battery-Operated Systems  
Communication Systems  
Automotive Systems

### Ordering Information

PART	PIN-PACKAGE	BITS	NO. OF CHANNELS
MAX11661AUT+	6 SOT23	8	1
MAX11662AUB+	10 μMAX-EP*	8	2
MAX11663AUT+	6 SOT23	10	1
MAX11664AUB+	10 μMAX-EP*	10	2
MAX11665AUT+	6 SOT23	12	1
MAX11666AUB+	10 μMAX-EP*	12	2
MAX11666AUB/V+	10 μMAX-EP*	12	2

**Note:** All devices are specified over the -40°C to +125°C operating temperature range.

+Denotes a lead(Pb)-free/RoHS-compliant package.

\*EP = Exposed pad.

/V denotes an automotive qualified part.

QSPI is a trademark of Motorola, Inc.

MICROWIRE is a registered trademark of National Semiconductor Corp.

μMAX is a registered trademark of Maxim Integrated Products, Inc.



# 500ksps, Low-Power, Serial 12-/10-/8-Bit ADCs

## ABSOLUTE MAXIMUM RATINGS

V <sub>DD</sub> to GND.....	-0.3V to +4V
REF, OVDD, AIN1, AIN2, AIN to GND.....	-0.3V to the lower of (V <sub>DD</sub> + 0.3V) and +4V
$\overline{\text{CS}}$ , SCLK, CHSEL, DOUT TO GND.....	-0.3V to the lower of (VOVDD + 0.3V) and +4V
AGND to GND.....	-0.3V to +0.3V
Input/Output Current (all pins) .....	50mA

Continuous Power Dissipation (T <sub>A</sub> = +70°C)	
6-Pin SOT23 (derate 8.7mW/°C above +70°C) .....	696mW
10-Pin $\mu$ MAX (derate 8.8mW/°C above +70°C).....	707.3mW
Operating Temperature Range .....	-40°C to +125°C
Junction Temperature .....	+150°C
Storage Temperature Range.....	-65°C to +150°C
Lead Temperature (soldering, 10s) .....	+300°C
Soldering Temperature (reflow) .....	+260°C

Stresses beyond those listed under "Absolute Maximum Ratings" may cause permanent damage to the device. These are stress ratings only, and functional operation of the device at these or any other conditions beyond those indicated in the operational sections of the specifications is not implied. Exposure to absolute maximum rating conditions for extended periods may affect device reliability.

## ELECTRICAL CHARACTERISTICS (MAX11666)

(V<sub>DD</sub> = 2.2V to 3.6V, V<sub>REF</sub> = V<sub>DD</sub>, V<sub>OVDD</sub> = V<sub>DD</sub>, f<sub>SCLK</sub> = 8MHz, 50% duty cycle, 500ksps. C<sub>DOUT</sub> = 10pF, T<sub>A</sub> = -40°C to +125°C, unless otherwise noted. Typical values are at T<sub>A</sub> = +25°C.) (Note 1)

PARAMETER	SYMBOL	CONDITIONS	MIN	TYP	MAX	UNITS
<b>DC ACCURACY</b>						
Resolution			12			Bits
Integral Nonlinearity	INL				±1	LSB
Differential Nonlinearity	DNL	No missing codes			±1	LSB
Offset Error	OE			±0.3	±4	LSB
Gain Error	GE	Excluding offset and reference errors		±1	±3	LSB
Total Unadjusted Error	TUE			±1		LSB
Channel-to-Channel Offset Matching				±0.4		LSB
Channel-to-Channel Gain Matching				±0.05		LSB
<b>DYNAMIC PERFORMANCE (f<sub>AIN</sub> = 250kHz)</b>						
Signal-to-Noise and Distortion	SINAD		70	72		dB
Signal-to-Noise Ratio	SNR		70.5	72.5		dB
Total Harmonic Distortion	THD			-85	-74.5	dB
Spurious-Free Dynamic Range	SFDR		75.5	85		dB
Intermodulation Distortion	IMD	f <sub>1</sub> = 239.8kHz, f <sub>2</sub> = 200.2kHz		-84		dB
Full-Power Bandwidth		-3dB point		40		MHz
Full-Linear Bandwidth		SINAD > 68dB		2.5		MHz
Small-Signal Bandwidth				45		MHz
Crosstalk				-90		dB

# 500ksps, Low-Power, Serial 12-/10-/8-Bit ADCs

MAX11661-MAX11666

## ELECTRICAL CHARACTERISTICS (MAX11666) (continued)

( $V_{DD} = 2.2V$  to  $3.6V$ ,  $V_{REF} = V_{DD}$ ,  $V_{OVDD} = V_{DD}$ .  $f_{SCLK} = 8MHz$ , 50% duty cycle, 500ksps.  $C_{DOUT} = 10pF$ ,  $T_A = -40^{\circ}C$  to  $+125^{\circ}C$ , unless otherwise noted. Typical values are at  $T_A = +25^{\circ}C$ .) (Note 1)

PARAMETER	SYMBOL	CONDITIONS	MIN	TYP	MAX	UNITS
<b>CONVERSION RATE</b>						
Throughput			5		500	ksps
Conversion Time			1.56			$\mu s$
Acquisition Time	$t_{ACQ}$		52			ns
Aperture Delay		From $\overline{CS}$ falling edge		4		ns
Aperture Jitter				15		ps
Serial-Clock Frequency	$f_{CLK}$		0.08		8	MHz
<b>ANALOG INPUT (AIN1, AIN2)</b>						
Input Voltage Range	$V_{AIN\_}$		0		$V_{REF}$	V
Input Leakage Current	$I_{ILA}$			0.002	$\pm 1$	$\mu A$
Input Capacitance	$C_{AIN\_}$	Track		20		pF
		Hold		4		
<b>EXTERNAL REFERENCE INPUT (REF)</b>						
Reference Input Voltage Range	$V_{REF}$		1		$V_{DD} + 0.05$	V
Reference Input Leakage Current	$I_{ILR}$	Conversion stopped		0.005	$\pm 1$	$\mu A$
Reference Input Capacitance	$C_{REF}$			5		pF
<b>DIGITAL INPUTS (SCLK, <math>\overline{CS}</math>, CHSEL)</b>						
Digital Input High Voltage	$V_{IH}$		0.75 x $V_{OVDD}$			V
Digital Input Low Voltage	$V_{IL}$				0.25 x $V_{OVDD}$	V
Digital Input Hysteresis	$V_{HYST}$		0.15 x $V_{OVDD}$			V
Digital Input Leakage Current	$I_{IL}$	Inputs at GND or $V_{DD}$		0.001	$\pm 1$	$\mu A$
Digital Input Capacitance	$C_{IN}$			2		pF
<b>DIGITAL OUTPUT (DOUT)</b>						
Output High Voltage	$V_{OH}$	$I_{SOURCE} = 200\mu A$	0.85 x $V_{OVDD}$			V
Output Low Voltage	$V_{OL}$	$I_{SINK} = 200\mu A$			0.15 x $V_{OVDD}$	V
High-Impedance Leakage Current	$I_{OL}$				$\pm 1.0$	$\mu A$
High-Impedance Output Capacitance	$C_{OUT}$			4		pF

## 500ksps, Low-Power, Serial 12-/10-/8-Bit ADCs

### ELECTRICAL CHARACTERISTICS (MAX11666) (continued)

( $V_{DD} = 2.2V$  to  $3.6V$ ,  $V_{REF} = V_{DD}$ ,  $V_{OVDD} = V_{DD}$ .  $f_{SCLK} = 8MHz$ , 50% duty cycle, 500ksps.  $C_{DOUT} = 10pF$ ,  $T_A = -40^{\circ}C$  to  $+125^{\circ}C$ , unless otherwise noted. Typical values are at  $T_A = +25^{\circ}C$ .) (Note 1)

PARAMETER	SYMBOL	CONDITIONS	MIN	TYP	MAX	UNITS
<b>POWER SUPPLY</b>						
Positive Supply Voltage	$V_{DD}$		2.2		3.6	V
Digital I/O Supply Voltage	$V_{OVDD}$		1.5		$V_{DD}$	V
Positive Supply Current (Full-Power Mode)	$I_{VDD}$	$V_{AIN\_} = V_{GND}$			1.67	mA
	$I_{OVDD}$	$V_{AIN\_} = V_{GND}$			0.1	
Positive Supply Current (Full-Power Mode), No Clock	$I_{VDD}$			1.5		mA
Power-Down Current	$I_{PD}$	Leakage only		1.3	10	$\mu A$
Line Rejection		$V_{DD} = 2.2V$ to $3.6V$ , $V_{REF} = 2.2V$		0.7		LSB/V
<b>TIMING CHARACTERISTICS (Note 2)</b>						
Quiet Time	$t_Q$	(Note 3)	4			ns
$\overline{CS}$ Pulse Width	$t_1$	(Note 3)	10			ns
$\overline{CS}$ Fall to SCLK Setup	$t_2$	(Note 3)	5			ns
$\overline{CS}$ Falling Until DOUT High-Impedance Disabled	$t_3$	(Note 3)	1			ns
Data Access Time After SCLK Falling Edge	$t_4$	Figure 2, $V_{OVDD} = 2.2V$ to $3.6V$			15	ns
		Figure 2, $V_{OVDD} = 1.5V$ to $2.2V$			16.5	
SCLK Pulse Width Low	$t_5$	Percentage of clock period (Note 3)	40		60	%
SCLK Pulse Width High	$t_6$	Percentage of clock period (Note 3)	40		60	%
Data Hold Time From SCLK Falling Edge	$t_7$	Figure 3	5			ns
SCLK Falling Until DOUT High Impedance	$t_8$	Figure 4 (Note 3)	2.5		14	ns
Power-Up Time		Conversion cycle (Note 3)			1	Cycle

### ELECTRICAL CHARACTERISTICS (MAX11665)

( $V_{DD} = 2.2V$  to  $3.6V$ ,  $f_{SCLK} = 8MHz$ , 50% duty cycle, 500ksps,  $C_{DOUT} = 10pF$ ,  $T_A = -40^{\circ}C$  to  $+125^{\circ}C$ , unless otherwise noted. Typical values are at  $T_A = +25^{\circ}C$ .) (Note 1)

PARAMETER	SYMBOL	CONDITIONS	MIN	TYP	MAX	UNITS
<b>DC ACCURACY</b>						
Resolution			12			Bits
Integral Nonlinearity	INL				$\pm 1$	LSB
Differential Nonlinearity	DNL	No missing codes			$\pm 1$	LSB
Offset Error	OE			$\pm 1.5$	$\pm 4$	LSB
Gain Error	GE	Excluding offset and reference errors		$\pm 1$	$\pm 3$	LSB
Total Unadjusted Error	TUE			$\pm 1.5$		LSB
<b>DYNAMIC PERFORMANCE (<math>f_{AIN} = 250kHz</math>)</b>						
Signal-to-Noise and Distortion	SINAD		70	72.5		dB
Signal-to-Noise Ratio	SNR		70.5	73		dB

# 500ksps, Low-Power, Serial 12-/10-/8-Bit ADCs

MAX11661-MAX11666

## ELECTRICAL CHARACTERISTICS (MAX11665) (continued)

(V<sub>DD</sub> = 2.2V to 3.6V, f<sub>SCLK</sub> = 8MHz, 50% duty cycle, 500ksps, C<sub>DOUT</sub> = 10pF, T<sub>A</sub> = -40°C to +125°C, unless otherwise noted. Typical values are at T<sub>A</sub> = +25°C.) (Note 1)

PARAMETER	SYMBOL	CONDITIONS	MIN	TYP	MAX	UNITS
Total Harmonic Distortion	THD			-85	-76	dB
Spurious-Free Dynamic Range	SFDR		77	85		dB
Intermodulation Distortion	IMD	f <sub>1</sub> = 239.8kHz, f <sub>2</sub> = 200.2kHz		-84		dB
Full-Power Bandwidth		-3dB point		40		MHz
Full-Linear Bandwidth		SINAD > 68dB		2.5		MHz
Small-Signal Bandwidth				45		MHz
<b>CONVERSION RATE</b>						
Throughput			5		500	ksps
Conversion Time			1.56			μs
Acquisition Time	t <sub>ACQ</sub>		52			ns
Aperture Delay		From $\overline{\text{CS}}$ falling edge		4		ns
Aperture Jitter				15		ps
Serial Clock Frequency	f <sub>CLK</sub>		0.08		8	MHz
<b>ANALOG INPUT</b>						
Input Voltage Range	V <sub>AIN</sub>		0		V <sub>DD</sub>	V
Input Leakage Current	I <sub>ILA</sub>			0.002	±1	μA
Input Capacitance	C <sub>AIN</sub>	Track		20		pF
		Hold		4		
<b>DIGITAL INPUTS (SCLK, <math>\overline{\text{CS}}</math>, CHSEL)</b>						
Digital Input High Voltage	V <sub>IH</sub>		0.75 x V <sub>VDD</sub>			V
Digital Input Low Voltage	V <sub>IL</sub>				0.25 x V <sub>VDD</sub>	V
Digital Input Hysteresis	V <sub>HYST</sub>			0.15 x V <sub>VDD</sub>		V
Digital Input Leakage Current	I <sub>IL</sub>	Inputs at GND or V <sub>DD</sub>		0.001	±1	μA
Digital Input Capacitance	C <sub>IN</sub>			2		pF
<b>DIGITAL OUTPUT (DOUT)</b>						
Output High Voltage	V <sub>OH</sub>	I <sub>SOURCE</sub> = 200μA	0.85 x V <sub>VDD</sub>			V
Output Low Voltage	V <sub>OL</sub>	I <sub>SINK</sub> = 200μA			0.15 x V <sub>VDD</sub>	V
High-Impedance Leakage Current	I <sub>OL</sub>				±1.0	μA
High-Impedance Output Capacitance	C <sub>OUT</sub>			4		pF
<b>POWER SUPPLY</b>						
Positive Supply Voltage	V <sub>DD</sub>		2.2		3.6	V
Positive Supply Current (Full-Power Mode)	I <sub>VDD</sub>	V <sub>AIN</sub> = V <sub>GND</sub>			1.76	mA

## 500ksps, Low-Power, Serial 12-/10-/8-Bit ADCs

### ELECTRICAL CHARACTERISTICS (MAX11665) (continued)

( $V_{DD} = 2.2V$  to  $3.6V$ ,  $f_{SCLK} = 8MHz$ , 50% duty cycle, 500ksps,  $C_{DOUT} = 10pF$ ,  $T_A = -40^{\circ}C$  to  $+125^{\circ}C$ , unless otherwise noted. Typical values are at  $T_A = +25^{\circ}C$ .) (Note 1)

PARAMETER	SYMBOL	CONDITIONS	MIN	TYP	MAX	UNITS
Positive Supply Current (Full-Power Mode), No Clock	$I_{VDD}$			1.48		mA
Power-Down Current	$I_{PD}$	Leakage only		1.3	10	$\mu A$
Line Rejection		$V_{DD} = 2.2V$ to $3.6V$		0.7		LSB/V
<b>TIMING CHARACTERISTICS (Note 2)</b>						
Quiet Time	$t_Q$	(Note 3)	4			ns
$\overline{CS}$ Pulse Width	$t_1$	(Note 3)	10			ns
$\overline{CS}$ Fall to SCLK Setup	$t_2$	(Note 3)	5			ns
$\overline{CS}$ Falling Until DOUT High-Impedance Disabled	$t_3$	(Note 3)	1			ns
Data Access Time After SCLK Falling Edge	$t_4$	Figure 2, $V_{DD} = 2.2V$ to $3.6V$			15	ns
SCLK Pulse Width Low	$t_5$	Percentage of clock period (Note 3)	40		60	%
SCLK Pulse Width High	$t_6$	Percentage of clock period (Note 3)	40		60	%
Data Hold Time From SCLK Falling Edge	$t_7$	Figure 3	5			ns
SCLK Falling Until DOUT High Impedance	$t_8$	Figure 4 (Note 3)	2.5		14	ns
Power-Up Time		Conversion cycle (Note 3)			1	Cycle

### ELECTRICAL CHARACTERISTICS (MAX11664)

( $V_{DD} = 2.2V$  to  $3.6V$ ,  $V_{REF} = V_{DD}$ ,  $V_{OVDD} = V_{DD}$ ,  $f_{SCLK} = 8MHz$ , 50% duty cycle, 500ksps;  $C_{DOUT} = 10pF$ ,  $T_A = -40^{\circ}C$  to  $+125^{\circ}C$ , unless otherwise noted. Typical values are at  $T_A = +25^{\circ}C$ .) (Note 1)

PARAMETER	SYMBOL	CONDITIONS	MIN	TYP	MAX	UNITS
<b>DC ACCURACY</b>						
Resolution			10			Bits
Integral Nonlinearity	INL				$\pm 0.5$	LSB
Differential Nonlinearity	DNL	No missing codes			$\pm 0.5$	LSB
Offset Error	OE			$\pm 0.5$	$\pm 1.3$	LSB
Gain Error	GE	Excluding offset and reference errors		0	$\pm 1.3$	LSB
Total Unadjusted Error	TUE			$\pm 0.5$		LSB
Channel-to-Channel Offset Matching				$\pm 0.1$		LSB
Channel-to-Channel Gain Matching				$\pm 0.05$		LSB
<b>DYNAMIC PERFORMANCE (<math>f_{AIN} = 250kHz</math>)</b>						
Signal-to-Noise and Distortion	SINAD		60.5	61.6		dB
Signal-to-Noise Ratio	SNR		60.5	61.6		dB
Total Harmonic Distortion	THD			-83	-73	dB
Spurious-Free Dynamic Range	SFDR		75			dB

# 500ksps, Low-Power, Serial 12-/10-/8-Bit ADCs

MAX11661-MAX11666

## ELECTRICAL CHARACTERISTICS (MAX11664) (continued)

(V<sub>DD</sub> = 2.2V to 3.6V, V<sub>REF</sub> = V<sub>DD</sub>, V<sub>OVDD</sub> = V<sub>DD</sub>, f<sub>SCLK</sub> = 8MHz, 50% duty cycle, 500ksps; C<sub>DOUT</sub> = 10pF, T<sub>A</sub> = -40°C to +125°C, unless otherwise noted. Typical values are at T<sub>A</sub> = +25°C.) (Note 1)

PARAMETER	SYMBOL	CONDITIONS	MIN	TYP	MAX	UNITS
Intermodulation Distortion	IMD	f <sub>1</sub> = 239.8kHz, f <sub>2</sub> = 200.2kHz		-82		dB
Full-Power Bandwidth		-3dB point		40		MHz
Full-Linear Bandwidth		SINAD > 60dB		2.5		MHz
Small-Signal Bandwidth				45		MHz
Crosstalk				-90		dB
<b>CONVERSION RATE</b>						
Throughput			5		500	ksps
Conversion Time			1.56			μs
Acquisition Time	t <sub>ACQ</sub>		52			ns
Aperture Delay		From $\overline{\text{CS}}$ falling edge		4		ns
Aperture Jitter				15		ps
Serial-Clock Frequency	f <sub>CLK</sub>		0.08		8	MHz
<b>ANALOG INPUT (AIN1, AIN2)</b>						
Input Voltage Range	V <sub>AIN_</sub>		0		V <sub>REF</sub>	V
Input Leakage Current	I <sub>ILA</sub>			0.002	±1	μA
Input Capacitance	C <sub>AIN_</sub>	Track		20		pF
		Hold		4		
<b>EXTERNAL REFERENCE INPUT (REF)</b>						
Reference Input Voltage Range	V <sub>REF</sub>		1		V <sub>DD</sub> + 0.05	V
Reference Input Leakage Current	I <sub>ILR</sub>	Conversion stopped		0.005	±1	μA
Reference Input Capacitance	C <sub>REF</sub>			5		pF
<b>DIGITAL INPUTS (SCLK, <math>\overline{\text{CS}}</math>, CHSEL)</b>						
Digital Input High Voltage	V <sub>IH</sub>		0.75 x V <sub>OVDD</sub>			V
Digital Input Low Voltage	V <sub>IL</sub>			0.25 x V <sub>OVDD</sub>		V
Digital Input Hysteresis	V <sub>HYST</sub>			0.15 x V <sub>OVDD</sub>		V
Digital Input Leakage Current	I <sub>IL</sub>	Inputs at GND or V <sub>DD</sub>		0.001	±1	μA
Digital Input Capacitance	C <sub>IN</sub>			2		pF
<b>DIGITAL OUTPUT (DOUT)</b>						
Output High Voltage	V <sub>OH</sub>	I <sub>SOURCE</sub> = 200μA	0.85 x V <sub>OVDD</sub>			V
Output Low Voltage	V <sub>OL</sub>	I <sub>SINK</sub> = 200μA		0.15 x V <sub>OVDD</sub>		V
High-Impedance Leakage Current	I <sub>OL</sub>			±1.0		μA
High-Impedance Output Capacitance	C <sub>OUT</sub>			4		pF

## 500ksps, Low-Power, Serial 12-/10-/8-Bit ADCs

### ELECTRICAL CHARACTERISTICS (MAX11664) (continued)

(V<sub>DD</sub> = 2.2V to 3.6V, V<sub>REF</sub> = V<sub>DD</sub>, V<sub>OVDD</sub> = V<sub>DD</sub>, f<sub>SCLK</sub> = 8MHz, 50% duty cycle, 500ksps; C<sub>DOUT</sub> = 10pF, T<sub>A</sub> = -40°C to +125°C, unless otherwise noted. Typical values are at T<sub>A</sub> = +25°C.) (Note 1)

PARAMETER	SYMBOL	CONDITIONS	MIN	TYP	MAX	UNITS
<b>POWER SUPPLY</b>						
Positive Supply Voltage	V <sub>DD</sub>		2.2		3.6	V
Digital I/O Supply Voltage	V <sub>OVDD</sub>		1.5		V <sub>DD</sub>	V
Positive Supply Current (Full-Power Mode)	I <sub>VDD</sub>	V <sub>AIN_</sub> = V <sub>GNDD</sub>			1.67	mA
	I <sub>OVDD</sub>	V <sub>AIN_</sub> = V <sub>GNDD</sub>			0.1	
Positive Supply Current (Full-Power Mode), No Clock	I <sub>VDD</sub>			1.5		mA
Power-Down Current	I <sub>PD</sub>	Leakage only		1.3	10	μA
Line Rejection		V <sub>DD</sub> = 2.2V to 3.6V, V <sub>REF</sub> = 2.2V		0.17		LSB/V
<b>TIMING CHARACTERISTICS (Note 2)</b>						
Quiet Time	t <sub>Q</sub>	(Note 3)	4			ns
CS Pulse Width	t <sub>1</sub>	(Note 3)	10			ns
CS Fall to SCLK Setup	t <sub>2</sub>	(Note 3)	5			ns
CS Falling Until DOUT High-Impedance Disabled	t <sub>3</sub>	(Note 3)	1			ns
Data Access Time After SCLK Falling Edge (Figure 2)	t <sub>4</sub>	V <sub>OVDD</sub> = 2.2V to 3.6V			15	ns
		V <sub>OVDD</sub> = 1.5V to 2.2V			16.5	
SCLK Pulse Width Low	t <sub>5</sub>	Percentage of clock period (Note 3)	40		60	%
SCLK Pulse Width High	t <sub>6</sub>	Percentage of clock period (Note 3)	40		60	%
Data Hold Time From SCLK Falling Edge	t <sub>7</sub>	Figure 3	5			ns
SCLK Falling Until DOUT High Impedance	t <sub>8</sub>	Figure 4 (Note 3)	2.5		14	ns
Power-Up Time		Conversion cycle (Note 3)			1	Cycle

### ELECTRICAL CHARACTERISTICS (MAX11663)

(V<sub>DD</sub> = 2.2V to 3.6V, f<sub>SCLK</sub> = 8MHz, 50% duty cycle, 500ksps, C<sub>DOUT</sub> = 10pF, T<sub>A</sub> = -40°C to +125°C, unless otherwise noted. Typical values are at T<sub>A</sub> = +25°C.) (Note 1)

PARAMETER	SYMBOL	CONDITIONS	MIN	TYP	MAX	UNITS
<b>DC ACCURACY</b>						
Resolution			10			Bits
Integral Nonlinearity	INL				±0.5	LSB
Differential Nonlinearity	DNL	No missing codes			±0.5	LSB
Offset Error	OE			±0.3	±1.3	LSB
Gain Error	GE	Excluding offset and reference errors		±0.15	±1.3	LSB
Total Unadjusted Error	TUE			±1		LSB

# 500ksps, Low-Power, Serial 12-/10-/8-Bit ADCs

MAX11661-MAX11666

## ELECTRICAL CHARACTERISTICS (MAX11663) (continued)

(V<sub>DD</sub> = 2.2V to 3.6V. f<sub>SCLK</sub> = 8MHz, 50% duty cycle, 500ksps. C<sub>DOUT</sub> = 10pF, T<sub>A</sub> = -40°C to +125°C, unless otherwise noted. Typical values are at T<sub>A</sub> = +25°C.) (Note 1)

PARAMETER	SYMBOL	CONDITIONS	MIN	TYP	MAX	UNITS
<b>DYNAMIC PERFORMANCE (f<sub>AIN</sub> = 250kHz)</b>						
Signal-to-Noise and Distortion	SINAD		60.5	61.5		dB
Signal-to-Noise Ratio	SNR		60.5	61.5		dB
Total Harmonic Distortion	THD			-85	-73	dB
Spurious-Free Dynamic Range	SFDR		75			dB
Intermodulation Distortion	IMD	f <sub>1</sub> = 239.8kHz, f <sub>2</sub> = 200.2kHz		-82		dB
Full-Power Bandwidth		-3dB point		40		MHz
Full-Linear Bandwidth		SINAD > 60dB		2.5		MHz
Small-Signal Bandwidth				45		MHz
<b>CONVERSION RATE</b>						
Throughput			5		500	ksps
Conversion Time			1.56			μs
Acquisition Time	t <sub>ACQ</sub>		52			ns
Aperture Delay		From $\overline{CS}$ falling edge		4		ns
Aperture Jitter				15		ps
Serial Clock Frequency	f <sub>CLK</sub>		0.08		8	MHz
<b>ANALOG INPUT (AIN)</b>						
Input Voltage Range	V <sub>AIN</sub>		0		V <sub>DD</sub>	V
Input Leakage Current	I <sub>ILA</sub>			0.002	±1	μA
Input Capacitance	C <sub>AIN</sub>	Track		20		pF
		Hold		4		
<b>DIGITAL INPUTS (SCLK, <math>\overline{CS}</math>, CHSEL)</b>						
Digital Input High Voltage	V <sub>IH</sub>		0.75 x			V
Digital Input Low Voltage	V <sub>IL</sub>				0.25 x	V
Digital Input Hysteresis	V <sub>HYST</sub>			0.15 x		V
Digital Input Leakage Current	I <sub>IL</sub>	Inputs at GND or V <sub>DD</sub>		0.001	±1	μA
Digital Input Capacitance	C <sub>IN</sub>			2		pF

# 500ksps, Low-Power, Serial 12-/10-/8-Bit ADCs

## ELECTRICAL CHARACTERISTICS (MAX11663) (continued)

( $V_{DD} = 2.2V$  to  $3.6V$ .  $f_{SCLK} = 8MHz$ , 50% duty cycle, 500ksps.  $C_{DOUT} = 10pF$ ,  $T_A = -40^{\circ}C$  to  $+125^{\circ}C$ , unless otherwise noted. Typical values are at  $T_A = +25^{\circ}C$ .) (Note 1)

PARAMETER	SYMBOL	CONDITIONS	MIN	TYP	MAX	UNITS
<b>DIGITAL OUTPUT (DOUT)</b>						
Output High Voltage	$V_{OH}$	$I_{SOURCE} = 200\mu A$	$0.85 \times V_{DD}$			V
Output Low Voltage	$V_{OL}$	$I_{SINK} = 200\mu A$			$0.15 \times V_{DD}$	V
High-Impedance Leakage Current	$I_{OL}$				$\pm 1.0$	$\mu A$
High-Impedance Output Capacitance	$C_{OUT}$			4		pF
<b>POWER SUPPLY</b>						
Positive Supply Voltage	$V_{DD}$		2.2		3.6	V
Positive Supply Current (Full-Power Mode)	$I_{VDD}$	$V_{AIN} = V_{GND}$			1.76	mA
Positive Supply Current (Full-Power Mode), No Clock	$I_{VDD}$			1.48		mA
Power-Down Current	$I_{PD}$	Leakage only		1.3	10	$\mu A$
Line Rejection		$V_{DD} = 2.2V$ to $3.6V$		0.17		LSB/V
<b>TIMING CHARACTERISTICS (Note 2)</b>						
Quiet Time	$t_Q$	(Note 3)	4			ns
$\overline{CS}$ Pulse Width	$t_1$	(Note 3)	10			ns
$\overline{CS}$ Fall to SCLK Setup	$t_2$	(Note 3)	5			ns
$\overline{CS}$ Falling Until DOUT High-Impedance Disabled	$t_3$	(Note 3)	1			ns
Data Access Time After SCLK Falling Edge	$t_4$	Figure 2, $V_{DD} = 2.2V$ to $3.6V$			15	ns
SCLK Pulse Width Low	$t_5$	Percentage of clock period (Note 3)	40		60	%
SCLK Pulse Width High	$t_6$	Percentage of clock period (Note 3)	40		60	%
Data Hold Time From SCLK Falling Edge	$t_7$	Figure 3	5			ns
SCLK Falling Until DOUT High Impedance	$t_8$	Figure 4 (Note 3)	2.5		14	ns
Power-Up Time		Conversion cycle (Note 3)			1	Cycle

# 500ksps, Low-Power, Serial 12-/10-/8-Bit ADCs

MAX11661-MAX11666

## ELECTRICAL CHARACTERISTICS (MAX11662)

( $V_{DD} = 2.2V$  to  $3.6V$ ,  $V_{REF} = V_{DD}$ ,  $V_{OVDD} = V_{DD}$ ,  $f_{SCLK} = 8MHz$ , 50% duty cycle, 500ksps,  $C_{DOUT} = 10pF$ ,  $T_A = -40^{\circ}C$  to  $+125^{\circ}C$ , unless otherwise noted. Typical values are at  $T_A = +25^{\circ}C$ .) (Note 1)

PARAMETER	SYMBOL	CONDITIONS	MIN	TYP	MAX	UNITS
<b>DC ACCURACY</b>						
Resolution			8			Bits
Integral Nonlinearity	INL				$\pm 0.25$	LSB
Differential Nonlinearity	DNL	No missing codes			$\pm 0.25$	LSB
Offset Error	OE			0.45	$\pm 0.8$	LSB
Gain Error	GE	Excluding offset and reference errors		0	$\pm 0.25$	LSB
Total Unadjusted Error	TUE			0.5		LSB
Channel-to-Channel Offset Matching				0.01		LSB
Channel-to-Channel Gain Matching				0.01		LSB
<b>DYNAMIC PERFORMANCE (<math>f_{AIN} = 250kHz</math>)</b>						
Signal-to-Noise and Distortion	SINAD		49	49.7		dB
Signal-to-Noise Ratio	SNR		49	49.7		dB
Total Harmonic Distortion	THD			-75	-67	dB
Spurious-Free Dynamic Range	SFDR		63	67		dB
Intermodulation Distortion	IMD	$f_1 = 239.8kHz$ , $f_2 = 200.2kHz$		-65		dB
Full-Power Bandwidth		-3dB point		40		MHz
Full-Linear Bandwidth		SINAD > 49dB		2.5		MHz
Small-Signal Bandwidth				45		MHz
Crosstalk				-90		dB
<b>CONVERSION RATE</b>						
Throughput			5		500	ksps
Conversion Time			1.56			$\mu s$
Acquisition Time	$t_{ACQ}$		52			ns
Aperture Delay		From $\overline{CS}$ falling edge		4		ns
Aperture Jitter				15		ps
Serial-Clock Frequency	$f_{CLK}$		0.08		8	MHz
<b>ANALOG INPUT (AIN1, AIN2)</b>						
Input Voltage Range	$V_{AIN\_}$		0		$V_{REF}$	V
Input Leakage Current	$I_{ILA}$			0.002	$\pm 1$	$\mu A$
Input Capacitance	$C_{AIN\_}$	Track		20		pF
		Hold		4		
<b>EXTERNAL REFERENCE INPUT (REF)</b>						
Reference Input Voltage Range	$V_{REF}$		1		$V_{DD} + 0.05$	V
Reference Input Leakage Current	$I_{ILR}$	Conversion stopped		0.005	$\pm 1$	$\mu A$
Reference Input Capacitance	$C_{REF}$			5		pF

# 500ksp/s, Low-Power, Serial 12-/10-/8-Bit ADCs

## ELECTRICAL CHARACTERISTICS (MAX11662) (continued)

( $V_{DD} = 2.2V$  to  $3.6V$ ,  $V_{REF} = V_{DD}$ ,  $V_{OVDD} = V_{DD}$ ,  $f_{SCLK} = 8MHz$ , 50% duty cycle, 500ksp/s,  $C_{DOUT} = 10pF$ ,  $T_A = -40^{\circ}C$  to  $+125^{\circ}C$ , unless otherwise noted. Typical values are at  $T_A = +25^{\circ}C$ .) (Note 1)

PARAMETER	SYMBOL	CONDITIONS	MIN	TYP	MAX	UNITS
<b>DIGITAL INPUTS (SCLK, <math>\overline{CS}</math>)</b>						
Digital Input High Voltage	$V_{IH}$		0.75 x $V_{OVDD}$			V
Digital Input Low Voltage	$V_{IL}$				0.25 x $V_{OVDD}$	V
Digital Input Hysteresis	$V_{HYST}$			0.15 x $V_{OVDD}$		V
Digital Input Leakage Current	$I_{IL}$	Inputs at GND or $V_{DD}$		0.001	$\pm 1$	$\mu A$
Digital Input Capacitance	$C_{IN}$			2		pF
<b>DIGITAL OUTPUT (DOUT)</b>						
Output High Voltage	$V_{OH}$	$I_{SOURCE} = 200\mu A$ (Note 3)	0.85 x $V_{OVDD}$			V
Output Low Voltage	$V_{OL}$	$I_{SINK} = 200\mu A$ (Note 3)			0.15 x $V_{OVDD}$	V
High-Impedance Leakage Current	$I_{OL}$				$\pm 1.0$	$\mu A$
High-Impedance Output Capacitance	$C_{OUT}$			4		pF
<b>POWER SUPPLY</b>						
Positive Supply Voltage	$V_{DD}$		2.2		3.6	V
Digital I/O Supply Voltage	$V_{OVDD}$		1.5		$V_{DD}$	V
Positive Supply Current (Full-Power Mode)	$I_{VDD}$	$V_{AIN\_} = V_{GND}$			1.67	mA
	$I_{OVDD}$	$V_{AIN\_} = V_{GND}$			0.1	
Positive Supply Current (Full-Power Mode), No Clock	$I_{VDD}$			1.5		mA
Power-Down Current	$I_{PD}$	Leakage only		1.3	10	$\mu A$
Line Rejection		$V_{DD} = 2.2V$ to $3.6V$ , $V_{REF} = 2.2V$		0.17		LSB/V
<b>TIMING CHARACTERISTICS (Note 2)</b>						
Quiet Time	$t_Q$	(Note 3)	4			ns
$\overline{CS}$ Pulse Width	$t_1$	(Note 3)	10			ns
$\overline{CS}$ Fall to SCLK Setup	$t_2$	(Note 3)	5			ns
$\overline{CS}$ Falling Until DOUT High-Impedance Disabled	$t_3$	(Note 3)	1			ns
Data Access Time After SCLK Falling Edge (Figure 2)	$t_4$	$V_{OVDD} = 2.2V$ to $3.6V$ (Note 3)			15	ns
		$V_{OVDD} = 1.5V$ to $2.2V$ (Note 3)			16.5	
SCLK Pulse Width Low	$t_5$	Percentage of clock period	40		60	%
SCLK Pulse Width High	$t_6$	Percentage of clock period	40		60	%
Data Hold Time From SCLK Falling Edge	$t_7$	Figure 3	5			ns
SCLK Falling Until DOUT High Impedance	$t_8$	Figure 4 (Note 3)	2.5		14	ns
Power-Up Time		Conversion cycle (Note 3)			1	Cycle

# 500ksps, Low-Power, Serial 12-/10-/8-Bit ADCs

**MAX11661-MAX11666**

## ELECTRICAL CHARACTERISTICS (MAX11661)

(V<sub>DD</sub> = 2.2V to 3.6V. f<sub>SCLK</sub> = 8MHz, 50% duty cycle, 500ksps. C<sub>DOUT</sub> = 10pF, T<sub>A</sub> = -40°C to +125°C, unless otherwise noted. Typical values are at T<sub>A</sub> = +25°C.) (Note 1)

PARAMETER	SYMBOL	CONDITIONS	MIN	TYP	MAX	UNITS
<b>DC ACCURACY</b>						
Resolution			8			Bits
Integral Nonlinearity	INL				±0.25	LSB
Differential Nonlinearity	DNL	No missing codes			±0.25	LSB
Offset Error	OE			±0.45	±0.8	LSB
Gain Error	GE	Excluding offset and reference errors		±0.04	±0.5	LSB
Total Unadjusted Error	TUE			±0.75		LSB
<b>DYNAMIC PERFORMANCE (f<sub>AIN</sub> = 250kHz)</b>						
Signal-to-Noise and Distortion	SINAD		49	49.5		dB
Signal-to-Noise Ratio	SNR		49	49.5		dB
Total Harmonic Distortion	THD			-70	-67	dB
Spurious-Free Dynamic Range	SFDR		63	66		dB
Intermodulation Distortion	IMD	f <sub>1</sub> = 239.8kHz, f <sub>2</sub> = 200.2kHz		-65		dB
Full-Power Bandwidth		-3dB point		40		MHz
Full-Linear Bandwidth		SINAD > 49dB		2.5		MHz
Small-Signal Bandwidth				45		MHz
<b>CONVERSION RATE</b>						
Throughput			5		500	ksps
Conversion Time			1.56			µs
Acquisition Time	t <sub>ACQ</sub>		52			ns
Aperture Delay		From $\overline{CS}$ falling edge		4		ns
Aperture Jitter				15		ps
Serial-Clock Frequency	f <sub>CLK</sub>		0.08		8	MHz
<b>ANALOG INPUT (AIN)</b>						
Input Voltage Range	V <sub>AIN</sub>		0		V <sub>DD</sub>	V
Input Leakage Current	I <sub>ILA</sub>			0.002	±1	µA
Input Capacitance	C <sub>AIN</sub>	Track		20		pF
		Hold		4		
<b>DIGITAL INPUTS (SCLK, <math>\overline{CS}</math>)</b>						
Digital Input High Voltage	V <sub>IH</sub>		0.75 x			V
Digital Input Low Voltage	V <sub>IL</sub>				0.25 x	V
Digital Input Hysteresis	V <sub>HYST</sub>			0.15		V
Digital Input Leakage Current	I <sub>IL</sub>	Inputs at GND or V <sub>DD</sub>		0.001	±1	µA
Digital Input Capacitance	C <sub>IN</sub>			2		pF

# 500ksps, Low-Power, Serial 12-/10-/8-Bit ADCs

## ELECTRICAL CHARACTERISTICS (MAX11661) (continued)

( $V_{DD} = 2.2V$  to  $3.6V$ .  $f_{SCLK} = 8MHz$ , 50% duty cycle, 500ksps.  $C_{DOUT} = 10pF$ ,  $T_A = -40^{\circ}C$  to  $+125^{\circ}C$ , unless otherwise noted. Typical values are at  $T_A = +25^{\circ}C$ .) (Note 1)

PARAMETER	SYMBOL	CONDITIONS	MIN	TYP	MAX	UNITS
<b>DIGITAL OUTPUT (DOUT)</b>						
Output High Voltage	$V_{OH}$	$I_{SOURCE} = 200\mu A$	$0.85 \times V_{DD}$			V
Output Low Voltage	$V_{OL}$	$I_{SINK} = 200\mu A$			$0.15 \times V_{DD}$	V
High-Impedance Leakage Current	$I_{OL}$				$\pm 1.0$	$\mu A$
High-Impedance Output Capacitance	$C_{OUT}$			4		pF
<b>POWER SUPPLY</b>						
Positive Supply Voltage	$V_{DD}$		2.2		3.6	V
Positive Supply Current (Full-Power Mode)	$I_{VDD}$	$V_{AIN} = V_{GND}$			1.76	mA
Positive Supply Current (Full-Power Mode), No Clock	$I_{VDD}$			1.48		mA
Power-Down Current	$I_{PD}$	Leakage only		1.3	10	$\mu A$
Line Rejection		$V_{DD} = 2.2V$ to $3.6V$		0.17		LSB/V
<b>TIMING CHARACTERISTICS (Note 2)</b>						
Quiet Time	$t_Q$	(Note 3)	4			ns
$\overline{CS}$ Pulse Width	$t_1$	(Note 3)	10			ns
$\overline{CS}$ Fall to SCLK Setup	$t_2$	(Note 3)	5			ns
$\overline{CS}$ Falling Until DOUT High-Impedance Disabled	$t_3$	(Note 3)	1			ns
Data Access Time After SCLK Falling Edge	$t_4$	Figure 2, $V_{DD} = 2.2V$ to $3.6V$			15	ns
SCLK Pulse Width Low	$t_5$	Percentage of clock period (Note 3)	40		60	%
SCLK Pulse Width High	$t_6$	Percentage of clock period (Note 3)	40		60	%
Data Hold Time From SCLK Falling Edge	$t_7$	Figure 3	5			ns
SCLK Falling Until DOUT High Impedance	$t_8$	Figure 4 (Note 3)	2.5		14	ns
Power-Up Time		Conversion cycle (Note 3)			1	Cycle

**Note 1:** Limits at  $T_A = -40^{\circ}C$  are guaranteed by design and not production tested.

**Note 2:** All timing specifications given are with a 10pF capacitor.

**Note 3:** Guaranteed by design in characterization; not production tested.

# 500kps, Low-Power, Serial 12-/10-/8-Bit ADCs

MAX11661-MAX11666

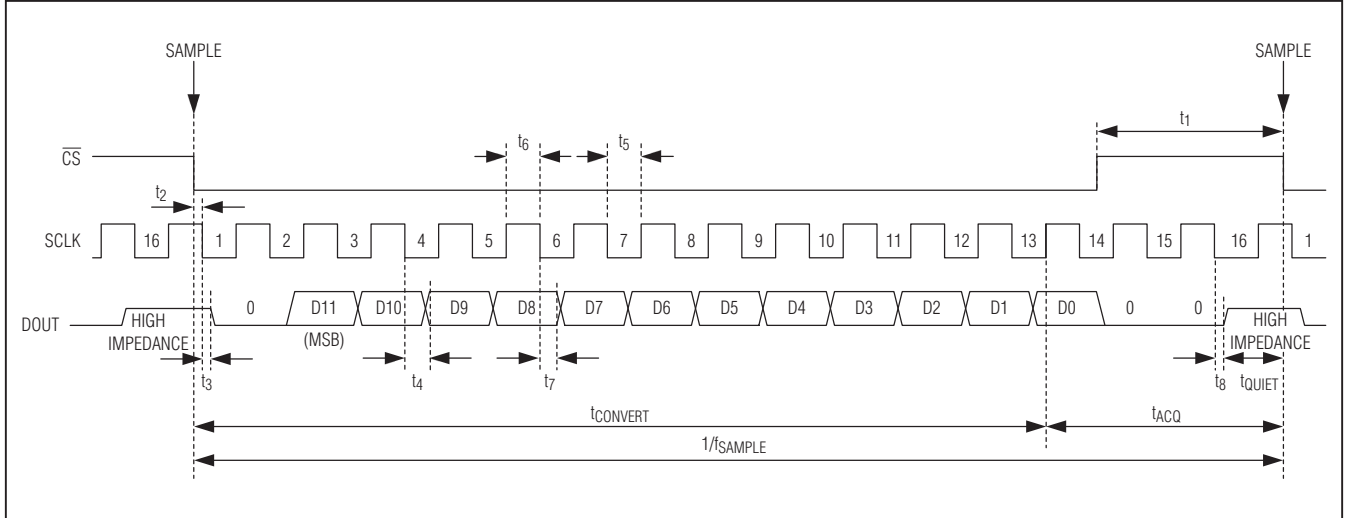

Figure 1. Interface Signals for Maximum Throughput, 12-Bit Devices

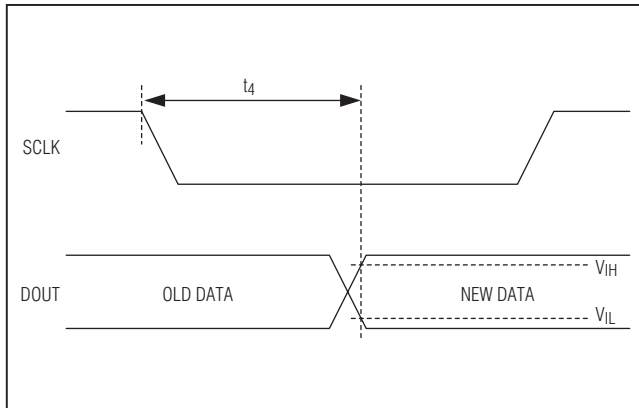

Figure 2. Setup Time After SCLK Falling Edge

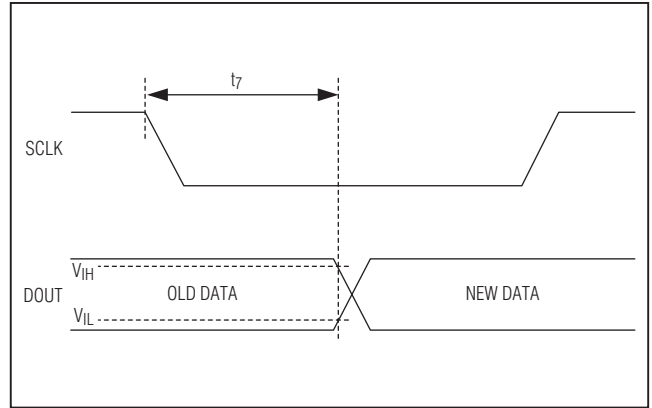

Figure 3. Hold Time After SCLK Falling Edge

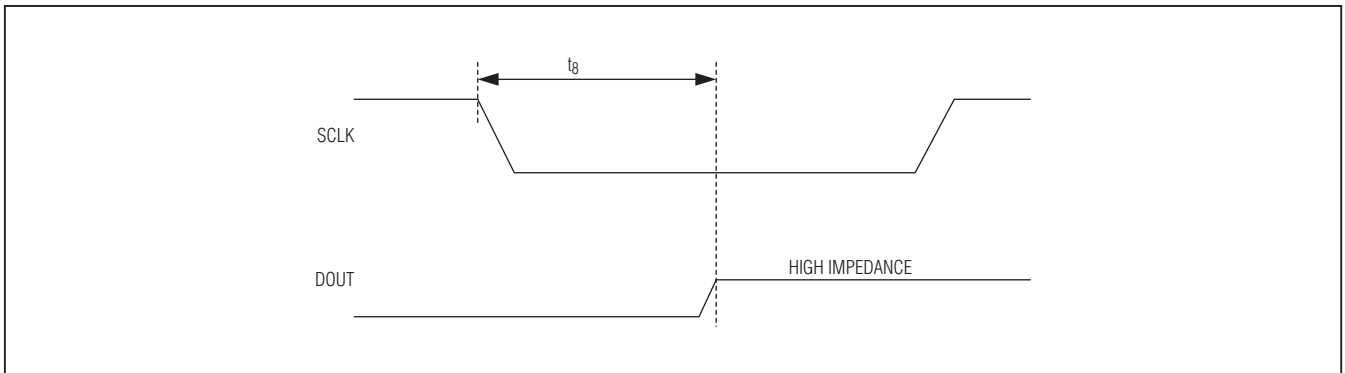

Figure 4. SCLK Falling Edge DOUT Three-State

# 500kps, Low-Power, Serial 12-/10-/8-Bit ADCs

## Typical Operating Characteristics

(MAX11665AUT+,  $T_A = +25^\circ\text{C}$ , unless otherwise noted.)

### SOT23 TYPICAL OPERATING CHARACTERISTICS

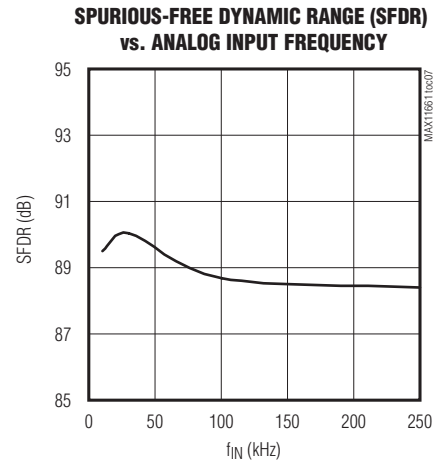
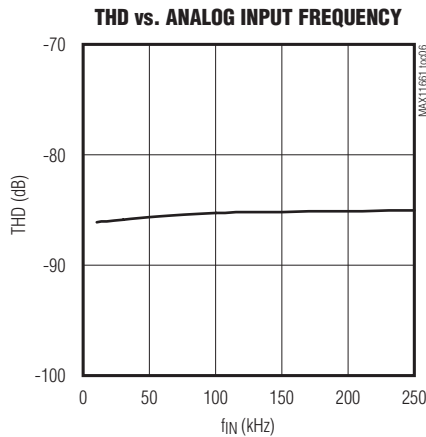
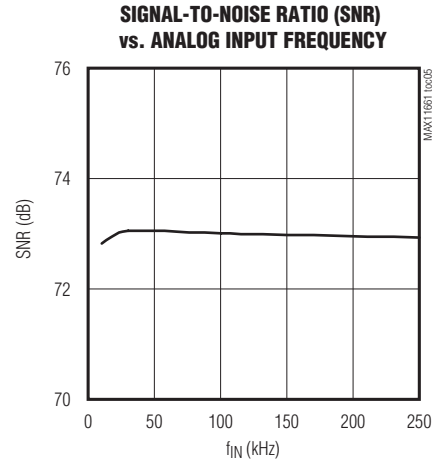
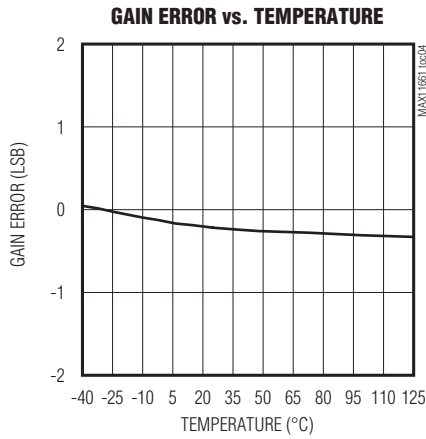
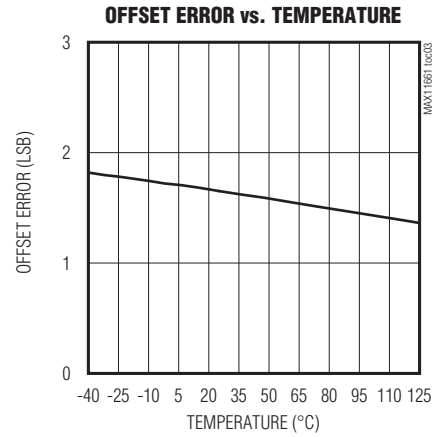
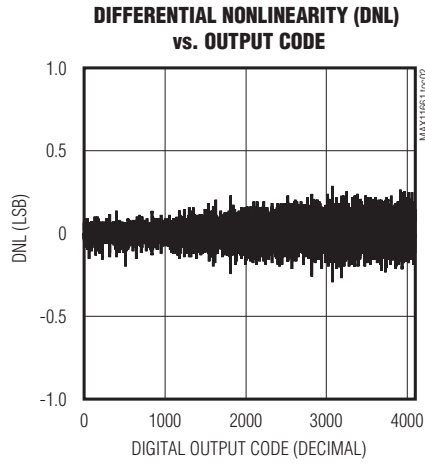
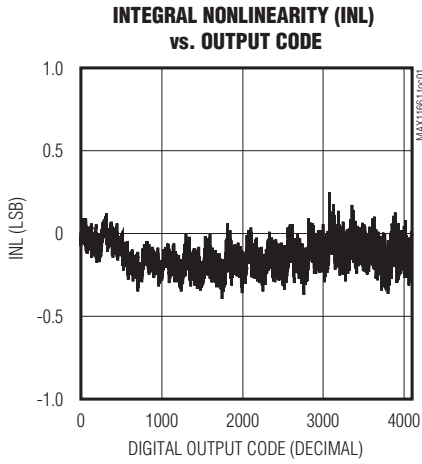

# 500ksp/s, Low-Power, Serial 12-/10-/8-Bit ADCs

MAX11661-MAX11666

## Typical Operating Characteristics (continued)

(MAX11665AUT+,  $T_A = +25^\circ\text{C}$ , unless otherwise noted.)

### SOT23 TYPICAL OPERATING CHARACTERISTICS

**SIGNAL-TO-NOISE AND DISTORTION RATIO (SINAD) vs. ANALOG INPUT FREQUENCY**

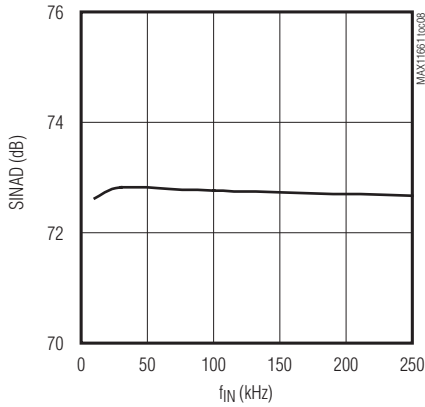

**100kHz SINE-WAVE INPUT**

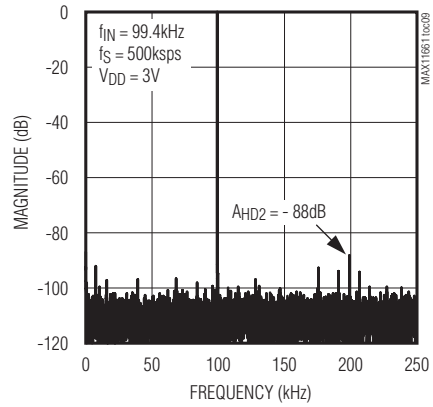

**SUPPLY CURRENT vs. TEMPERATURE**

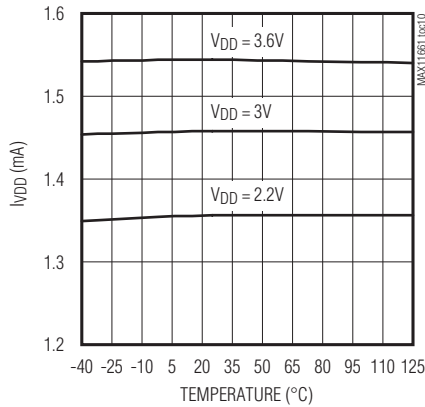

**SIGNAL-TO-NOISE RATIO (SNR) vs. SUPPLY VOLTAGE ( $V_{DD}$ )**

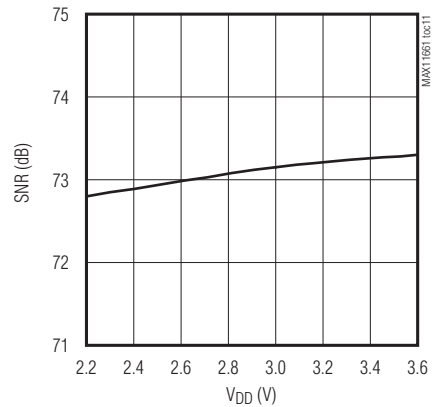

**HISTOGRAM FOR 30,000 CONVERSIONS**

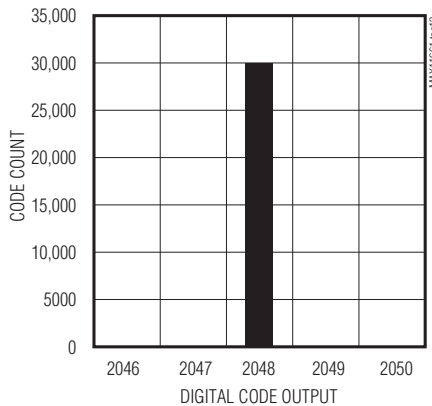

**THD vs. INPUT RESISTANCE**

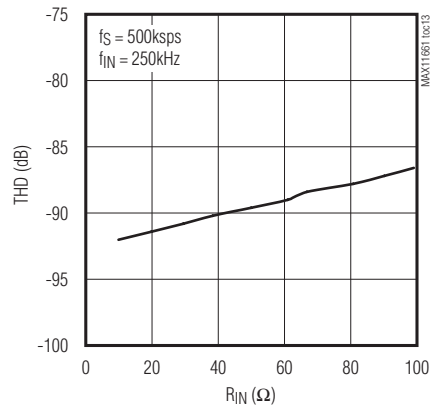

# 500ksp/s, Low-Power, Serial 12-/10-/8-Bit ADCs

## Pin Configurations

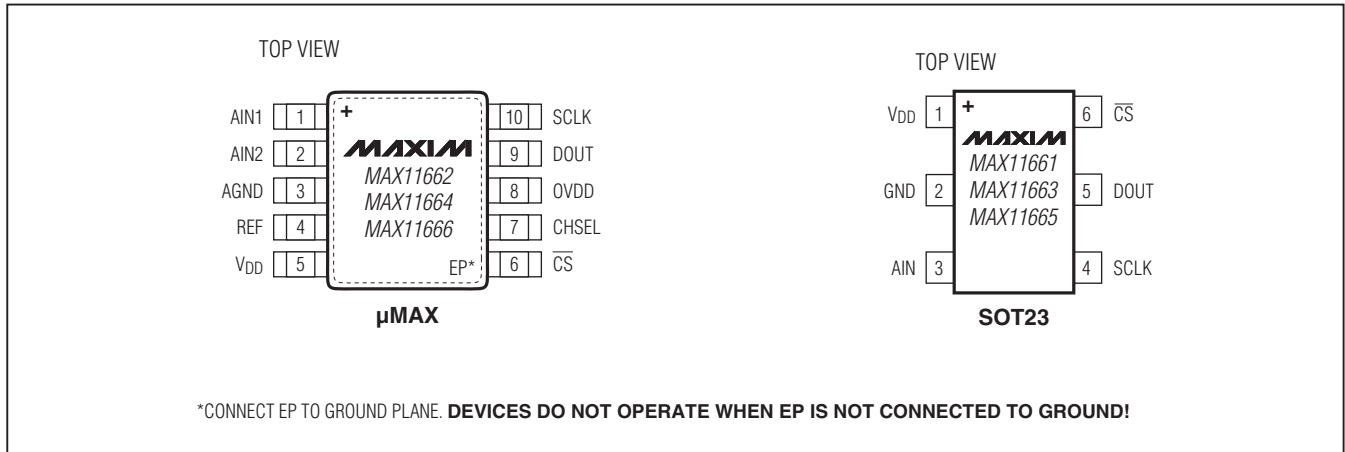

## Pin Description

PIN		NAME	FUNCTION
μMAX	SOT23		
1	—	AIN1	Analog Input Channel 1. Single-ended analog input with respect to AGND with range of 0V to VREF.
2	—	AIN2	Analog Input Channel 2. Single-ended analog input with respect to AGND with range of 0V to VREF.
—	3	AIN	Analog Input Channel. Single-ended analog input with respect to GND with range of 0V to VDD.
—	2	GND	Ground. Connect GND to the GND ground plane.
3	—	AGND	Analog Ground. Connect AGND directly the GND ground plane.
4	—	REF	External Reference Input. REF defines the signal range of the input signal AIN1/AIN2: 0V to VREF. The range of VREF is 1V to VDD. Bypass REF to AGND with 10μF    0.1μF capacitor.
5	1	VDD	Positive Supply Voltage. Bypass VDD with a 10μF    0.1μF capacitor to GND. VDD range is 2.2V to 3.6V. For the SOT23 package, VDD also defines the signal range of the input signal AIN: 0V to VDD.
6	6	$\overline{CS}$	Active-Low Chip-Select Input. The falling edge of $\overline{CS}$ samples the analog input signal, starts a conversion, and frames the serial-data transfer.
7	—	CHSEL	Channel Select. Set CHSEL high to select AIN2 for conversion. Set CHSEL low to select AIN1 for conversion.
8	—	OVDD	Digital Interface Supply for SCLK, $\overline{CS}$ , DOUT, and CHSEL. The OVDD range is 1.5V to VDD. Bypass OVDD with a 10μF    0.1μF capacitor to GND.
9	5	DOUT	Three-State Serial-Data Output. ADC conversion results are clocked out on the falling edge of SCLK, MSB first. See Figure 1.
10	4	SCLK	Serial-Clock Input. SCLK drives the conversion process. DOUT is updated on the falling edge of SCLK. See Figures 2 and 3.
—	—	EP	Exposed Pad (μMAX Only). Connect EP directly to a solid ground plane. <b>Devices do not operate when EP is not connected to ground!</b>

# 500ksp/s, Low-Power, Serial 12-/10-/8-Bit ADCs

## Functional Diagrams

**MAX11661-MAX11666**

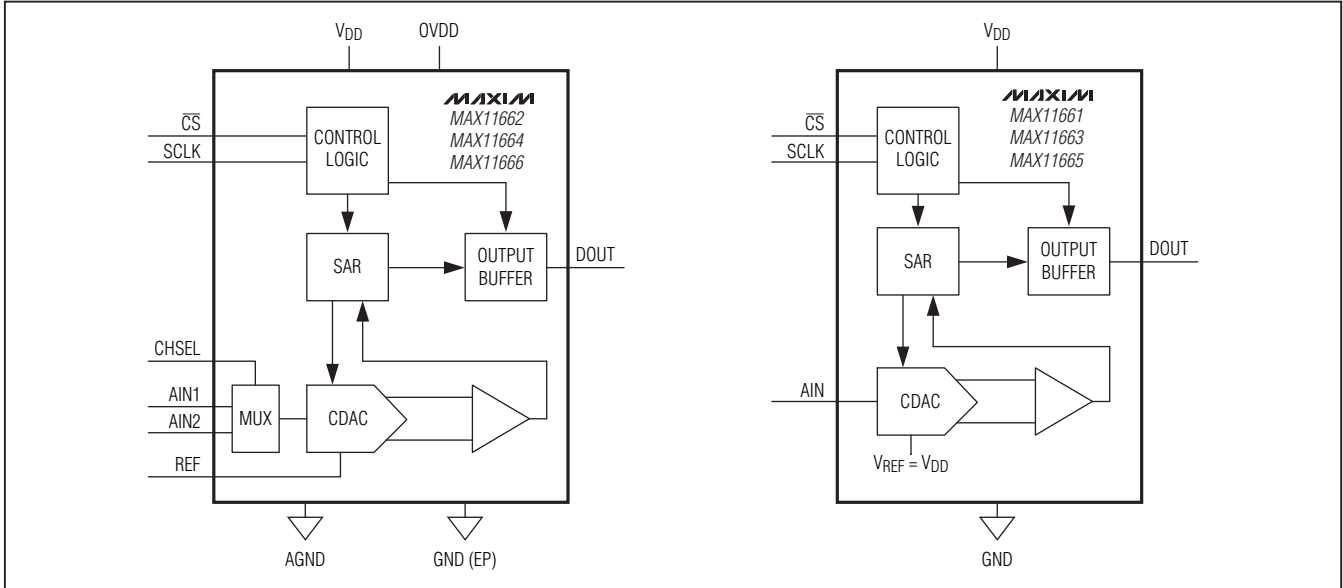

## Typical Operating Circuit

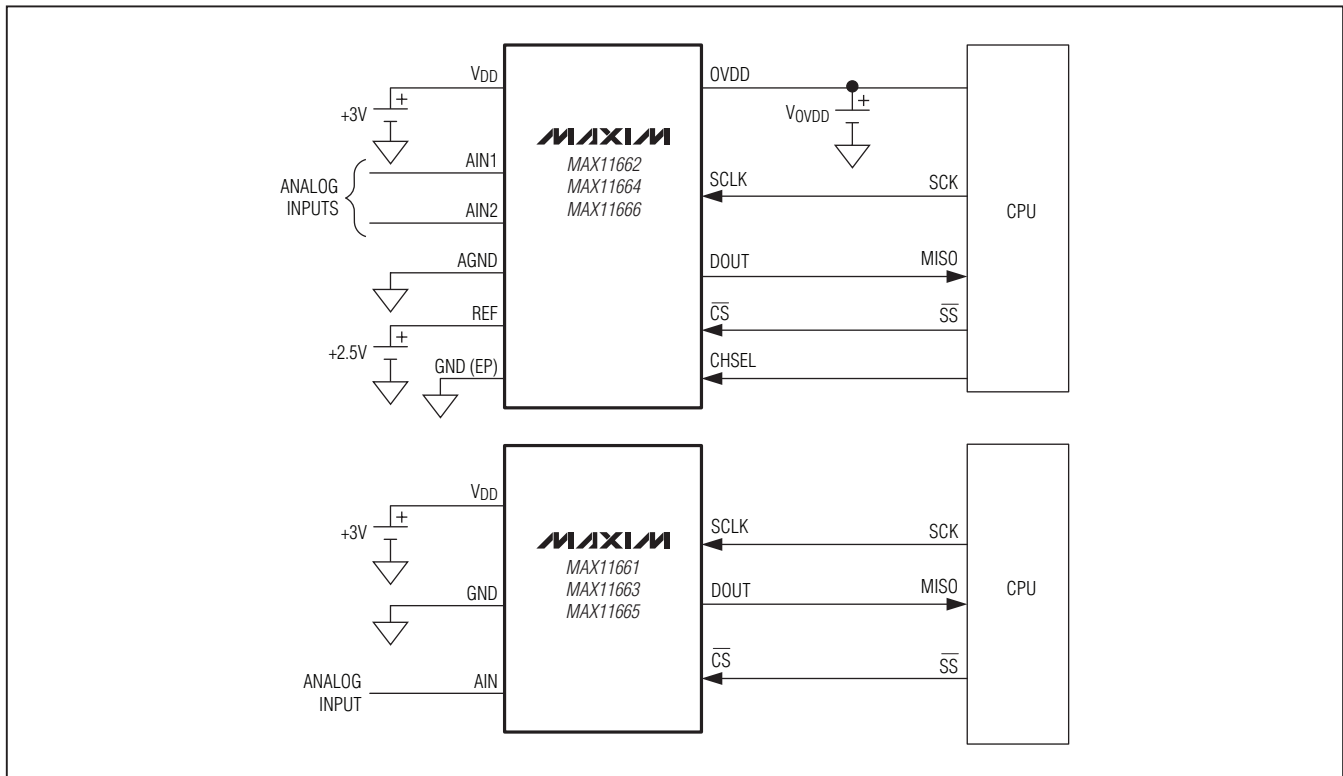

# 500ksp/s, Low-Power, Serial 12-/10-/8-Bit ADCs

## Detailed Description

The MAX11661-MAX11666 are fast, 12-/10-/8-bit, low-power, single-supply ADCs. The devices operate from a 2.2V to 3.6V supply and consume only 2.98mW ( $V_{DD} = 2.2V$ ) or 4.37mW ( $V_{DD} = 3V$ ). These devices are capable of sampling at full rate when driven by an 8MHz clock. The dual-channel devices provide a separate digital supply input (OVDD) to power the digital interface enabling communication with 1.5V, 1.8V, 2.5V, or 3V digital systems.

The conversion result appears at DOUT, MSB first, with a leading zero followed by the 12-bit, 10-bit, or 8-bit result. A 12-bit result is followed by two trailing zeros, a 10-bit result is followed by four trailing zeros, and an 8-bit result is followed by six trailing zeros. See Figures 1 and 5.

The dual-channel devices feature a dedicated reference input (REF). The input signal range for AIN1/AIN2 is defined as 0V to  $V_{REF}$  with respect to AGND. The single-channel devices use  $V_{DD}$  as the reference. The input signal range of AIN is defined as 0V to  $V_{DD}$  with respect to GND.

These ADCs include a power-down feature allowing minimized power consumption at 2.5 $\mu$ A/ksp/s for lower

throughput rates. The wake-up and power-down feature is controlled by using the SPI interface as described in the *Operating Modes* section.

## Serial Interface

The devices feature a 3-wire serial interface that directly connects to SPI, QSPI, and MICROWIRE devices without external logic. Figures 1 and 5 show the interface signals for a single conversion frame to achieve maximum throughput.

The falling edge of  $\overline{CS}$  defines the sampling instant. Once  $\overline{CS}$  transitions low, the external clock signal (SCLK) controls the conversion.

The SAR core successively extracts binary-weighted bits in every clock cycle. The MSB appears on the data bus during the 2nd clock cycle with a delay outlined in the timing specifications. All extracted data bits appear successively on the data bus with the LSB appearing during the 13th/11th/9th clock cycle for 12-/10-/8-bit operation. The serial data stream of conversion bits is preceded by a leading "zero" and succeeded by trailing "zeros." The data output (DOUT) goes into a high-impedance state during the 16th clock cycle.

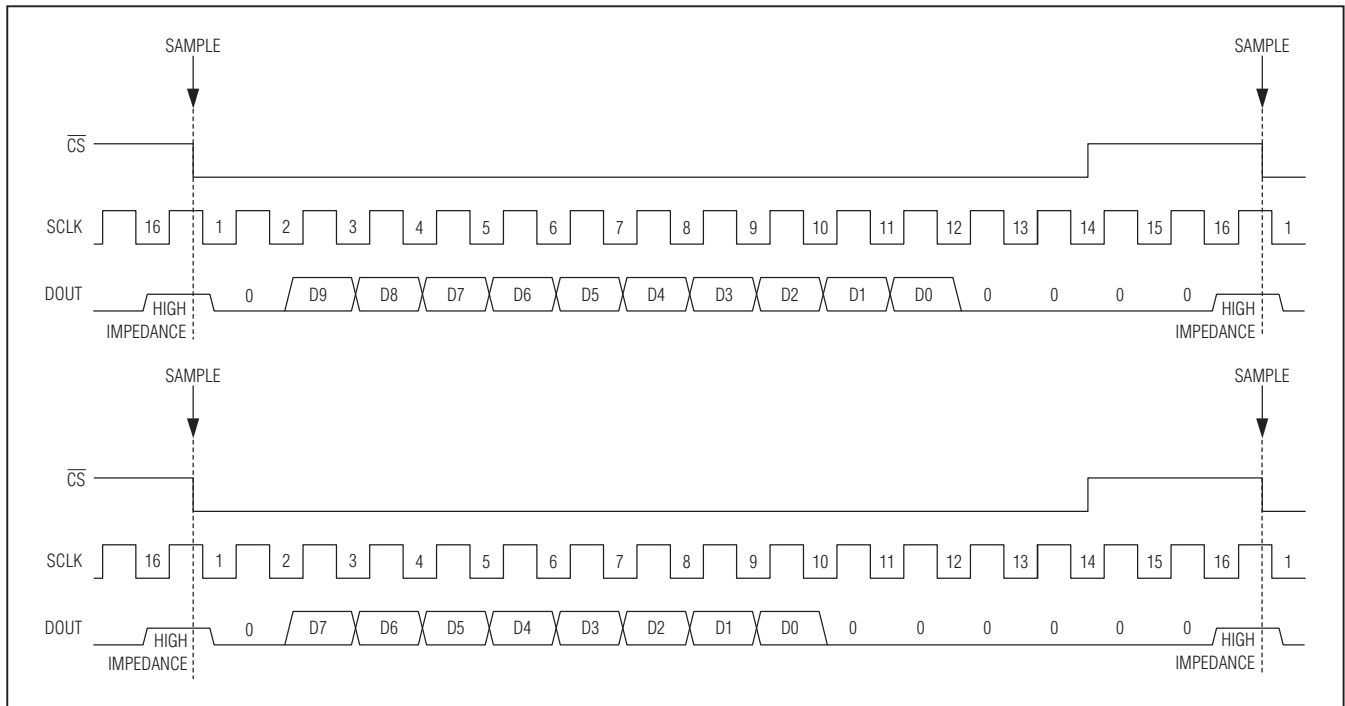

Figure 5. 10-/8-Bit Timing Diagrams

## 500kps, Low-Power, Serial 12-/10-/8-Bit ADCs

To sustain the maximum sample rate, all devices have to be resampled immediately after the 16th clock cycle. For lower sample rates, the  $\overline{CS}$  falling edge can be delayed leaving DOUT in a high-impedance condition. Pull  $\overline{CS}$  high after the 10th SCLK falling edge (see the *Operating Modes* section).

### Analog Input

The devices produce a digital output that corresponds to the analog input voltage within the specified operating range of 0V to  $V_{REF}$  for the dual-channel devices and 0V to  $V_{DD}$  for the single-channel devices.

Figure 6 shows an equivalent circuit for the analog input AIN (for single-channel devices) and AIN1/AIN2 (for dual-channel devices). Internal protection diodes D1/D2 confine the analog input voltage within the power rails ( $V_{DD}$ , GND). The analog input voltage can swing from  $GND - 0.3V$  to  $V_{DD} + 0.3V$  without damaging the device.

The electric load presented to the external stage driving the analog input varies depending on which mode the ADC is in: track mode vs. conversion mode. In track mode, the internal sampling capacitor  $C_S$  (16pF) has to be charged through the resistor  $R$  ( $R = 50\Omega$ ) to the input voltage. For faithful sampling of the input, the capacitor voltage on  $C_S$  has to settle to the required accuracy during the track time.

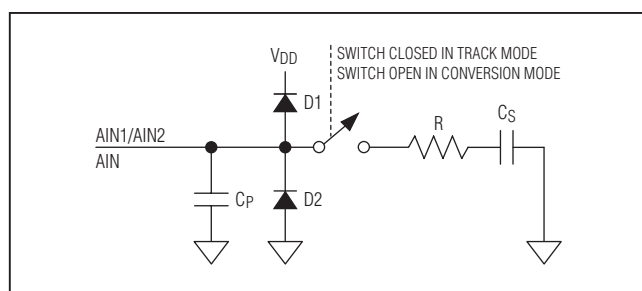

Figure 6. Analog Input Circuit

The source impedance of the external driving stage in conjunction with the sampling switch resistance affects the settling performance. The THD vs. Input Resistance graph in the *Typical Operating Characteristics* shows THD sensitivity as a function of the signal source impedance. Keep the source impedance at a minimum for high-dynamic-performance applications. Use a high-performance op amp such as the MAX4430 to drive the analog input, thereby decoupling the signal source and the ADC.

While the ADC is in conversion mode, the sampling switch is open presenting a pin capacitance,  $C_P$  ( $C_P = 5pF$ ), to the driving stage. See the *Applications Information* section for information on choosing an appropriate buffer for the ADC.

### ADC Transfer Function

The output format is straight binary. The code transitions midway between successive integer LSB values such as 0.5 LSB, 1.5 LSB, etc. The LSB size for single-channel devices is  $V_{DD}/2^n$  and for dual-channel devices is  $V_{REF}/2^n$ , where  $n$  is the resolution. The ideal transfer characteristic is shown in Figure 10.

### Operating Modes

The ICs offer two modes of operation: normal mode and power-down mode. The logic state of the  $\overline{CS}$  signal during a conversion activates these modes. The power-down mode can be used to optimize power dissipation with respect to sample rate.

#### Normal Mode

In normal mode, the devices are powered up at all times, thereby achieving their maximum throughput rates. Figure 7 shows the timing diagram of these devices in normal mode. The falling edge of  $\overline{CS}$  samples the analog input signal, starts a conversion, and frames the serial-data transfer.

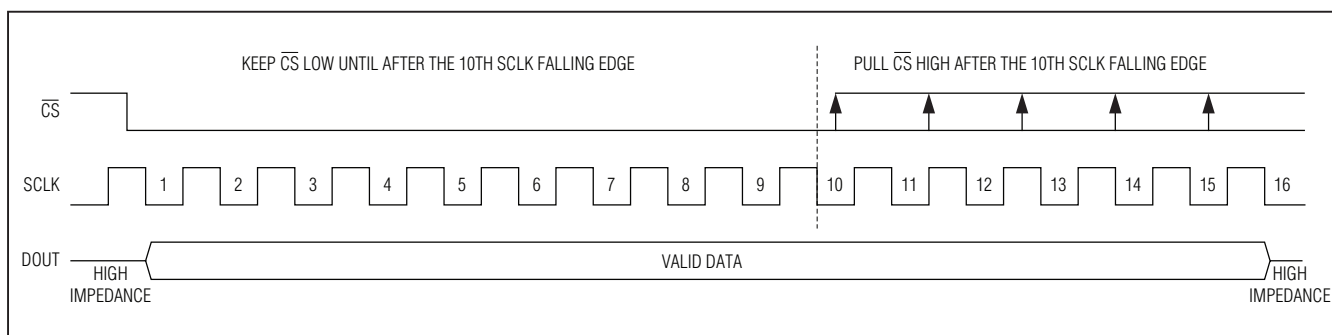

Figure 7. Normal Mode

# 500kps, Low-Power, Serial 12-/10-/8-Bit ADCs

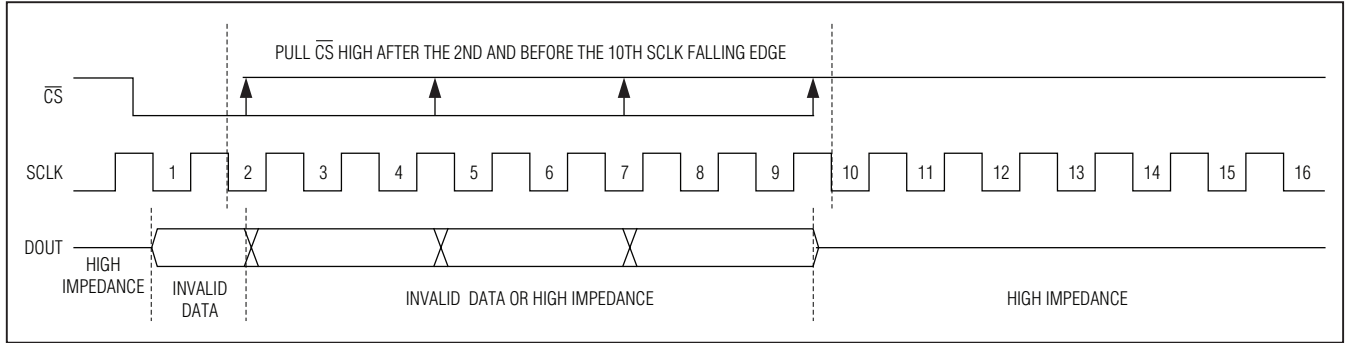

Figure 8. Entering Power-Down Mode

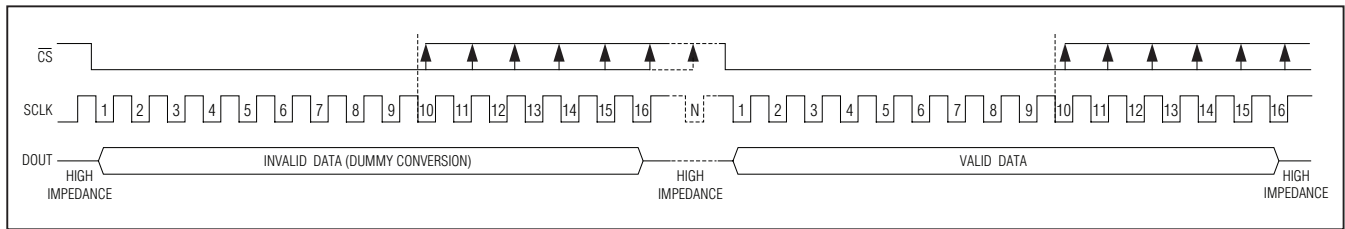

Figure 9. Exiting Power-Down Mode

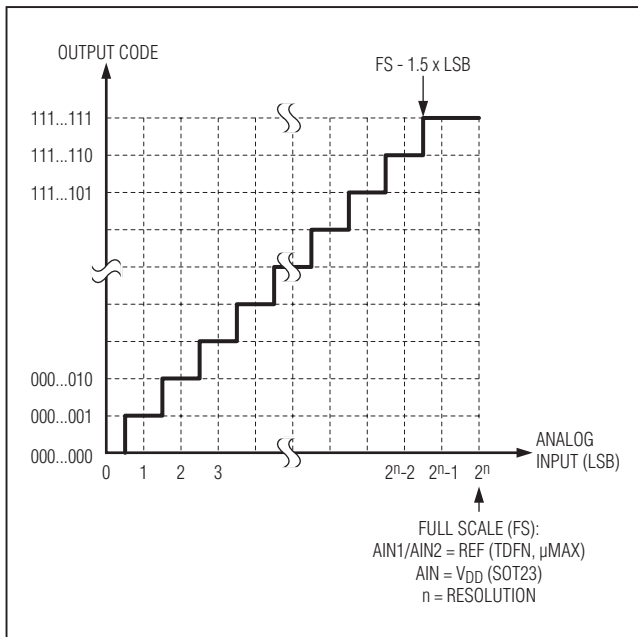

Figure 10. ADC Transfer Function

To remain in normal mode, keep  $\overline{CS}$  low until the falling edge of the 10th SCLK cycle. Pulling  $\overline{CS}$  high after the 10th SCLK falling edge keeps the part in normal mode.

However, pulling  $\overline{CS}$  high before the 10th SCLK falling edge terminates the conversion, DOUT goes into high-impedance mode, and the device enters power-down mode. See Figure 8.

### Power-Down Mode

In power-down mode, all bias circuitry is shut down drawing typically only 1.3 $\mu$ A of leakage current. To save power, put the device in power-down mode between conversions. Using the power-down mode between conversions is ideal for saving power when sampling the analog input infrequently.

### Entering Power-Down Mode

To enter power-down mode, drive  $\overline{CS}$  high between the 2nd and 10th falling edges of SCLK (see Figure 8). By pulling  $\overline{CS}$  high, the current conversion terminates and DOUT enters high impedance.

### Exiting Power-Down Mode

To exit power-down mode, implement one dummy conversion by driving  $\overline{CS}$  low for at least 10 clock cycles (see Figure 9). The data on DOUT is invalid during this dummy conversion. The first conversion following the dummy cycle contains a valid conversion result.

The power-up time equals the duration of the dummy cycle, and is dependent on the clock frequency. The power-up time for 500kps operation (8MHz SCLK) is 2 $\mu$ s.

## 500ksp/s, Low-Power, Serial 12-/10-/8-Bit ADCs

### Supply Current vs. Sampling Rate

For applications requiring lower throughput rates, the user can reduce the clock frequency ( $f_{SCLK}$ ) to lower the sample rate. Figure 11 shows the typical supply current ( $I_{VDD}$ ) as a function of sample rate ( $f_S$ ) for the 500ksp/s devices. The part operates in normal mode and

is never powered down. The user can also power down the ADC between conversions by using the power-down mode. Figure 12 shows for the 500ksp/s device that as the sample rate is reduced, the device remains in the power-down state longer and the average supply current ( $I_{VDD}$ ) drops accordingly.

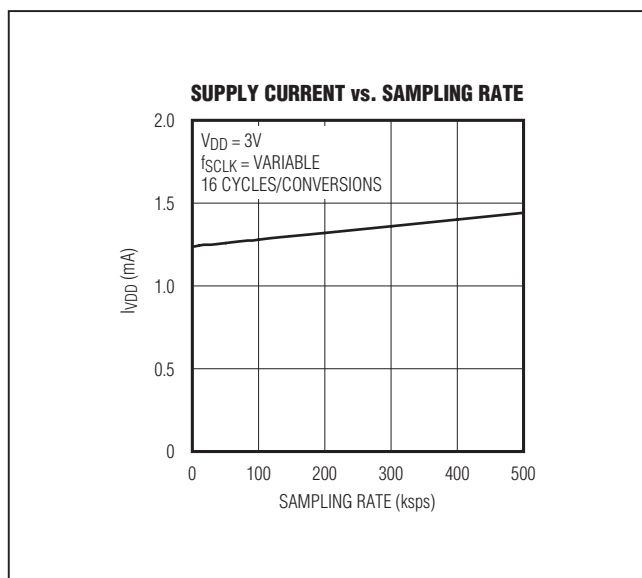

Figure 11. Supply Current vs. Sample Rate (Normal Operating Mode)

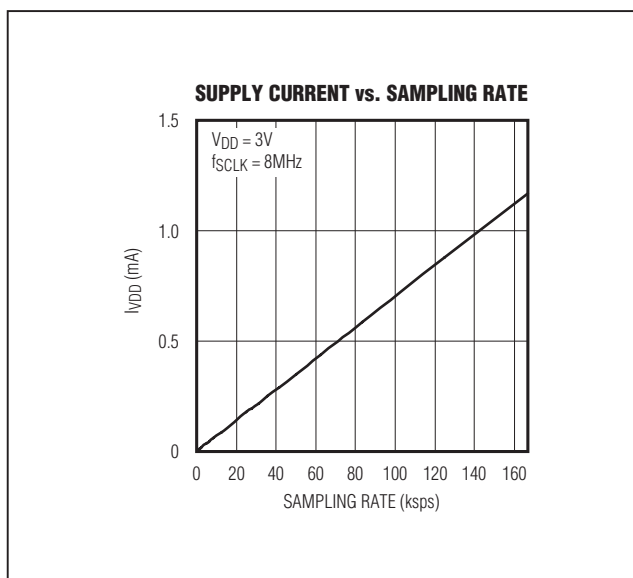

Figure 12. Supply Current vs. Sample Rate (Device Powered Down Between Conversions)

# 500ksp/s, Low-Power, Serial 12-/10-/8-Bit ADCs

## Dual-Channel Operation

The MAX11662/MAX11664/MAX11666 feature dual-input channels. These devices use a channel-select (CHSEL) input to select between analog input AIN1 (CHSEL = 0) or AIN2 (CHSEL = 1). As shown in Figure 13, the CHSEL signal is required to change between the 2nd and 12th clock cycle within a regular conversion to guarantee proper switching between channels.

## 14-Cycle Conversion Mode

The ICs can operate with 14 cycles per conversion. Figure 14 shows the corresponding timing diagram. Observe that DOUT does not go into high-impedance mode. Also, observe that  $t_{ACQ}$  needs to be sufficiently long to guarantee proper settling of the analog input voltage. See the *Electrical Characteristics* table for  $t_{ACQ}$  requirements and the *Analog Input* section for a description of the analog inputs.

## Applications Information

### Layout, Grounding, and Bypassing

For best performance, use PCBs with a solid ground plane. Ensure that digital and analog signal lines are separated from each other. Do not run analog and digital lines parallel to one another or digital lines underneath the ADC package. Noise in the  $V_{DD}$  power supply,  $OV_{DD}$ , and  $REF$  affects the ADC's performance. Bypass the  $V_{DD}$ ,  $OV_{DD}$ , and  $REF$  to ground with 0.1 $\mu$ F and 10 $\mu$ F bypass capacitors. Minimize capacitor lead and trace lengths for best supply-noise rejection.

### Choosing an Input Amplifier

It is important to match the settling time of the input amplifier to the acquisition time of the ADC. The conversion results are accurate when the ADC samples the input signal for an interval longer than the input signal's worst-case settling time. By definition, settling time is the interval between the application of an input voltage step and the point at which the output signal reaches

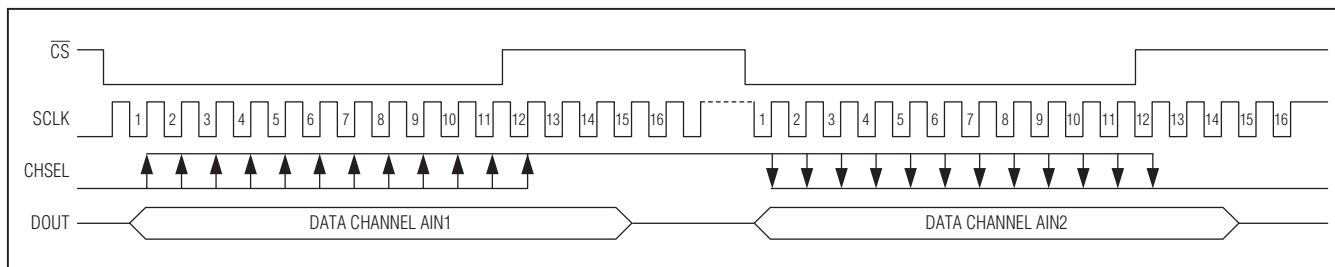

Figure 13. Channel Select Timing Diagram

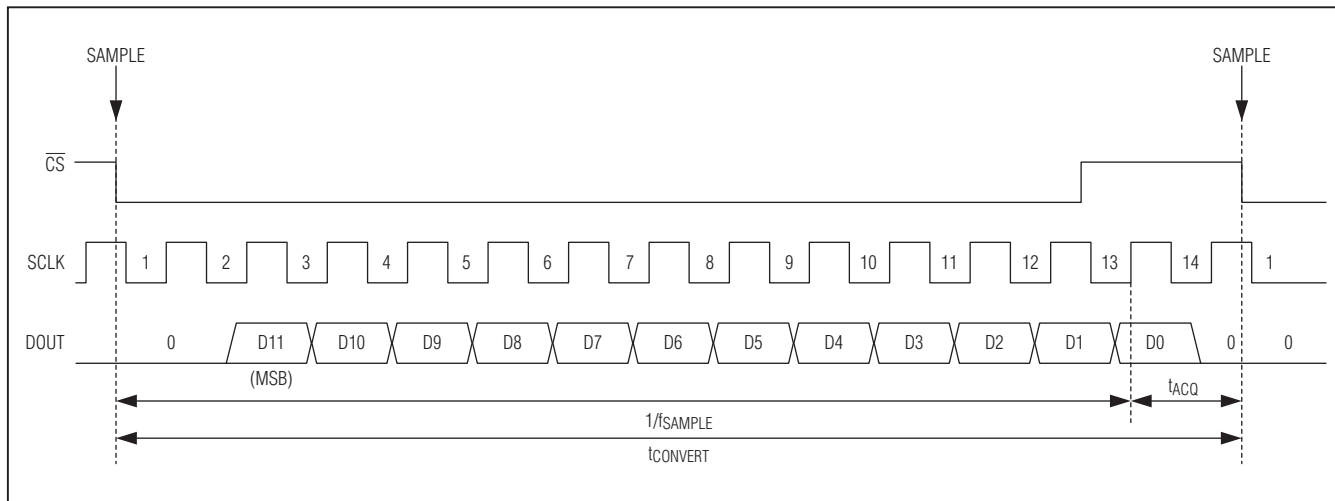

Figure 14. 14-Clock Cycle Operation

# 500kps, Low-Power, Serial 12-/10-/8-Bit ADCs

MAX11661-MAX11666

and stays within a given error band centered on the resulting steady-state amplifier output level. The ADC input sampling capacitor charges during the sampling cycle, referred to as the acquisition period. During this acquisition period, the settling time is affected by the input resistance and the input sampling capacitance. This error can be estimated by looking at the settling of an RC time constant using the input capacitance and the source impedance over the acquisition time period.

Figure 15 shows a typical application circuit. The MAX4430, offering a settling time of 37ns at 16 bits, is an excellent choice for this application. See the THD vs. Input Resistance graph in the *Typical Operating Characteristics*.

## Choosing a Reference

For devices using an external reference, the choice of the reference determines the output accuracy of the ADC. An ideal voltage reference provides a perfect initial accuracy and maintains the reference voltage independent of changes in load current, temperature, and time. Considerations in selecting a reference include initial voltage accuracy, temperature drift, current source, sink capability, quiescent current, and noise. Figure 15 shows a typical application circuit using the MAX6126 to provide the reference voltage. The MAX6033 and MAX6043 are also excellent choices.



Figure 15. Typical Application Circuit

# 500kps, Low-Power, Serial 12-/10-/8-Bit ADCs

## Definitions

### Integral Nonlinearity

Integral nonlinearity (INL) is the deviation of the values on an actual transfer function from a straight line. For these devices, the straight line is a line drawn between the end points of the transfer function after offset and gain errors are nulled.

### Differential Nonlinearity

Differential nonlinearity (DNL) is the difference between an actual step width and the ideal value of 1 LSB. A DNL error specification of  $\pm 1$  LSB or less guarantees no missing codes and a monotonic transfer function.

### Offset Error

The deviation of the first code transition (00 . . . 000) to (00 . . . 001) from the ideal, that is, AGND + 0.5 LSB.

### Gain Error

The deviation of the last code transition (111 . . . 110) to (111 . . . 111) from the ideal after adjusting for the offset error, that is, VREF - 1.5 LSB.

### Aperture Jitter

Aperture jitter ( $t_{AJ}$ ) is the sample-to-sample variation in the time between the samples.

### Aperture Delay

Aperture delay ( $t_{AD}$ ) is the time between the falling edge of sampling clock and the instant when an actual sample is taken.

### Signal-to-Noise Ratio (SNR)

SNR is a dynamic figure of merit that indicates the converter's noise performance. For a waveform perfectly reconstructed from digital samples, the theoretical maximum SNR is the ratio of the full-scale analog input (RMS value) to the RMS quantization error (residual error). The ideal, theoretical minimum analog-to-digital noise is caused by quantization error only and results directly from the ADC's resolution (N bits):

$$\text{SNR (dB) (MAX)} = (6.02 \times N + 1.76) \text{ (dB)}$$

In reality, there are other noise sources such as thermal noise, reference noise, and clock jitter that also degrade SNR. SNR is computed by taking the ratio of the RMS signal to the RMS noise. RMS noise includes all spectral components to the Nyquist frequency excluding the fundamental, the first five harmonics, and the DC offset.

### Signal-to-Noise Ratio and Distortion (SINAD)

SINAD is a dynamic figure of merit that indicates the converter's noise and distortion performance. SINAD is computed by taking the ratio of the RMS signal to the RMS noise plus distortion. RMS noise plus distortion includes all spectral components to the Nyquist frequency excluding the fundamental and the DC offset:

$$\text{SINAD(dB)} = 20 \times \log \left[ \frac{\text{SIGNAL}_{\text{RMS}}}{(\text{NOISE} + \text{DISTORTION})_{\text{RMS}}} \right]$$

### Total Harmonic Distortion

Total harmonic distortion (THD) is the ratio of the RMS sum of the first five harmonics of the input signal to the fundamental itself. This is expressed as:

$$\text{THD} = 20 \times \log \left( \frac{\sqrt{V_2^2 + V_3^2 + V_4^2 + V_5^2}}{V_1} \right)$$

where  $V_1$  is the fundamental amplitude and  $V_2$ – $V_5$  are the amplitudes of the 2nd- through 5th-order harmonics.

### Spurious-Free Dynamic Range (SFDR)

SFDR is a dynamic figure of merit that indicates the lowest usable input signal amplitude. SFDR is the ratio of the RMS amplitude of the fundamental (maximum signal component) to the RMS value of the next largest spurious component, excluding DC offset. SFDR is specified in decibels with respect to the carrier (dBc).

### Full-Power Bandwidth

Full-power bandwidth is the frequency at which the input signal amplitude attenuates by 3dB for a full-scale input.

### Full-Linear Bandwidth

Full-linear bandwidth is the frequency at which the signal-to-noise ratio and distortion (SINAD) is equal to a specified value.

### Intermodulation Distortion

Any device with nonlinearities creates distortion products when two sine waves at two different frequencies ( $f_1$  and  $f_2$ ) are applied into the device. Intermodulation distortion (IMD) is the total power of the IM2 to IM5 intermodulation products to the Nyquist frequency relative to the total input power of the two input tones,  $f_1$  and  $f_2$ . The individual input tone levels are at -6dBFS.

# 500ksps, Low-Power, Serial 12-/10-/8-Bit ADCs

## Chip Information

PROCESS: CMOS

## Package Information

For the latest package outline information and land patterns (footprints), go to [www.maxim-ic.com/packages](http://www.maxim-ic.com/packages). Note that a "+", "#", or "-" in the package code indicates RoHS status only. Package drawings may show a different suffix character, but the drawing pertains to the package regardless of RoHS status.

PACKAGE TYPE	PACKAGE CODE	OUTLINE NO.	LAND PATTERN NO.
10 $\mu$ MAX	U10E+3	<a href="#">21-0109</a>	<a href="#">90-0148</a>
6 SOT23	U6+1	<a href="#">21-0058</a>	<a href="#">90-0175</a>

MAX11661-MAX11666

# 500ksps, Low-Power, Serial 12-/10-/8-Bit ADCs

## Revision History

REVISION NUMBER	REVISION DATE	DESCRIPTION	PAGES CHANGED
0	11/10	Initial release	—
1	1/11	Released the MAX11663 and updated Figures 11 and 12.	1, 23
2	6/11	Released the MAX11662/MAX11664/MAX11666. Updated the <i>Electrical Characteristics</i> .	1–14
3	11/11	Updated the <i>Electrical Characteristics</i> , Figures 13 and 15.	4, 5, 6, 8, 10, 12, 14, 24, 25
4	1/12	Updated <i>Ordering Information</i> .	1
5	4/12	Corrected the Aperture Delay in the <i>Electrical Characteristics</i>	3

Maxim cannot assume responsibility for use of any circuitry other than circuitry entirely embodied in a Maxim product. No circuit patent licenses are implied. Maxim reserves the right to change the circuitry and specifications without notice at any time. The parametric values (min and max limits) shown in the *Electrical Characteristics* table are guaranteed. Other parametric values quoted in this data sheet are provided for guidance.

28 **Maxim Integrated Products, 120 San Gabriel Drive, Sunnyvale, CA 94086 408-737-7600**

## Looking for pricing, stock, or lifecycle information?

Click below to explore more details on WIN SOURCE:

- ⊖ [View MAX11661AUT+T on WIN SOURCE](#)
- ⊖ [Maxim Integrated Information](#)

## Optimize Your Supply Chain with WIN SOURCE Solutions

- ✓ Global Sourcing Solution
- ✓ Obsolete Management
- ✓ Cost Control Management
- ✓ Shortage Management
- ✓ Alternative Solution
- ✓ Excess Inventory Management