



**THE DATASHEET OF
FXP830.07.0100C**





TAOGLAS®



Datasheet

Freedom

Part No:
FXP830.07.0100C

Description

FXP830 Freedom Wi-Fi® 2.4/5.8/7.1GHz Dipole Antenna, Wi-Fi® 6 included with 100mm of 1.37mm cable and I-PEX MHF® I (U.FL) connector

Features:

- Flexible Polymer Antenna
- Covers Newly established Wi-Fi® 6 bands
- Covers 2.4/5.8/7.1GHz Wi-Fi® Bands
- Operates in Free Space (Ground Plane Independent)
- Cable: 100mm of \varnothing 1.37mm
- Connector: I-PEX MHF® I (U.FL comp)
- RoHS & Reach Compliant

1.	Introduction	3
2.	Specifications	4
3.	Mechanical Drawing	5
4.	Packaging	6
5.	Antenna Characteristics	7
6.	Radiation Patterns	11
<hr/>		
	Changelog	18

Taoglas makes no warranties based on the accuracy or completeness of the contents of this document and reserves the right to make changes to specifications and product descriptions at any time without notice. Taoglas reserves all rights to this document and the information contained herein. Reproduction, use or disclosure to third parties without express permission is strictly prohibited.

Ireland & USA
ISO 9001:2015
Certified



Taiwan
ISO 9001:2015
Certified



1. Introduction



The FXP830 is a high efficiency, small, dipole antenna covering 2.4/5.8/7.1GHz bands including Bluetooth®, Wi-Fi® and the newly established Wi-Fi® 6/Wi-Fi® 6E, making this an ideal solution for future-proofing an IoT device. This Taoglas patent pending antenna is unique in the market because it is made from poly-flexible material, has a tiny form factor (42*7*.01mm) and has double-sided 3M tape for easy “peel and stick” mounting.

The FXP830 is the ideal all-round antenna solution for squeezing into narrow spaces and still maintaining high performance, for example at the top of LCD devices.

Many module manufacturers specify peak gain limits for any antennas that are to be connected to that module. Those peak gain limits are based on free-space conditions. In practice, the peak gain of an antenna tested in free-space can degrade by at least 1 or 2dBi when put inside a device. So ideally you should go for a slightly higher peak gain antenna than mentioned on the module specification to compensate for this effect, giving you better performance.

Upon testing of any of our antennas with your device and a selection of appropriate layout, integration technique, or cable, Taoglas can make sure any of our antennas’ peak gain will be below the peak gain limits. Taoglas can then issue a specification and/or report for the selected antenna in your device that will clearly show it complying with the peak gain limits, so you can be assured you are meeting regulatory requirements for that module.

For example, a module manufacturer may state that the antenna must have less than 2dBi peak gain, but you don’t need to select an embedded antenna that has a peak gain of less than 2dBi in free-space. This will give you a less optimized solution. It is better to go for a slightly higher free-space peak gain of 3dBi or more if available. Once that antenna gets integrated into your device, performance will degrade below this 2dBi peak gain due to the effects of GND plane, surrounding components, and device housing. If you want to be absolutely sure, contact Taoglas and we will test. Choosing a Taoglas antenna with a higher peak gain than what is specified by the module manufacturer and enlisting our help will ensure you are getting the best performance possible without exceeding the peak gain limits.

The cable and connector are fully customizable, for further information contact your regional Taoglas customer support team.

2. Specifications

Wi-Fi Electrical									
Band	Frequency (MHz)	Measurement	Efficiency (%)	Average Gain (dB)	Peak Gain (dBi)	Impedance	Polarization	Radiation Pattern	Max. input power
Wi-Fi - 2GHz	2400-2500	2mm ABS	79.0	-1.02	3.46	50 Ω	Linear	Omni directional	10W
		Free Space	52.7	-2.78	2.14				
Wi-Fi - 5GHz	5150-5850	2mm ABS	63.4	-1.98	6.86				
		Free Space	65.4	-1.84	5.33				
Wi-Fi - 6GHz	5925-7125	2mm ABS	70.7	-1.51	8.09				
		Free Space	63.1	-2.00	6.49				

Mechanical	
Dimensions	42 x 7 x mm
Antenna Body Material	Polymer
Cable	Gray 100mm 1.37 co-axial
Connector	I-PEX MHF® I (U.FL Compatible)
Weight	7g

Environmental	
Operation Temperature	-40°C to 85°C
Storage Temperature	-40°C to 85°C
Relative Humidity	Non-condensing 65°C 95% RH

3. Mechanical Drawing

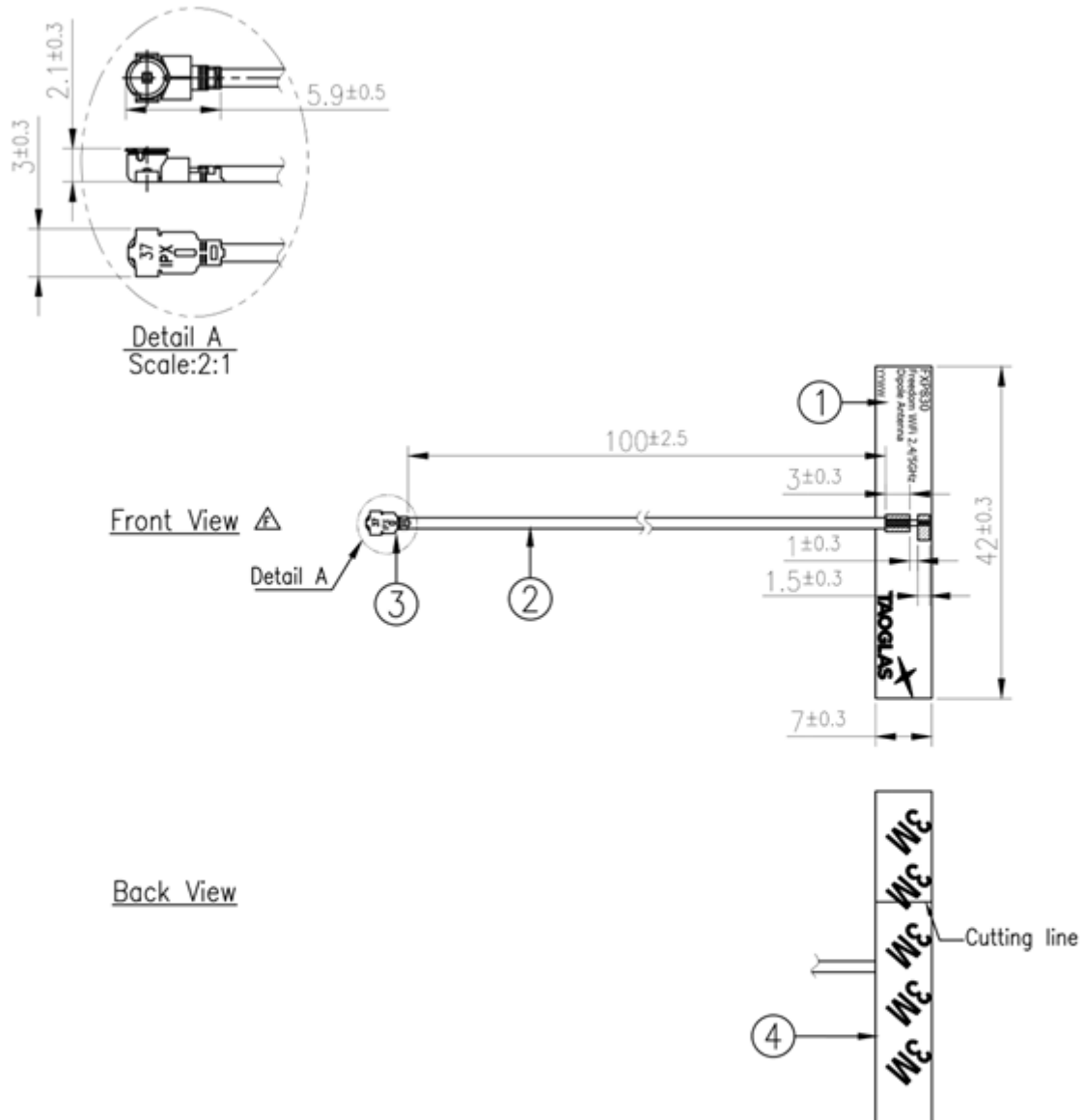

	Name	P/N	Material	Finish	QTY
1	FXP830 PCB	100111AD10011A	Polymer 0.24t	Black	1
2	1.37 Coaxial Cable	300415C000000A	FEP	Gray	1
3	IPEX MHFHT	204511G000000A	Brass	Au Plated	1
4	Double-Sided Adhesive	100111AD10011A	3M 467	Brown Liner	1

4. Packaging

100pcs FXP830.07.0100C per PE Large Bag
 Bag Dimensions - 130*230mm
 Weight - 72g

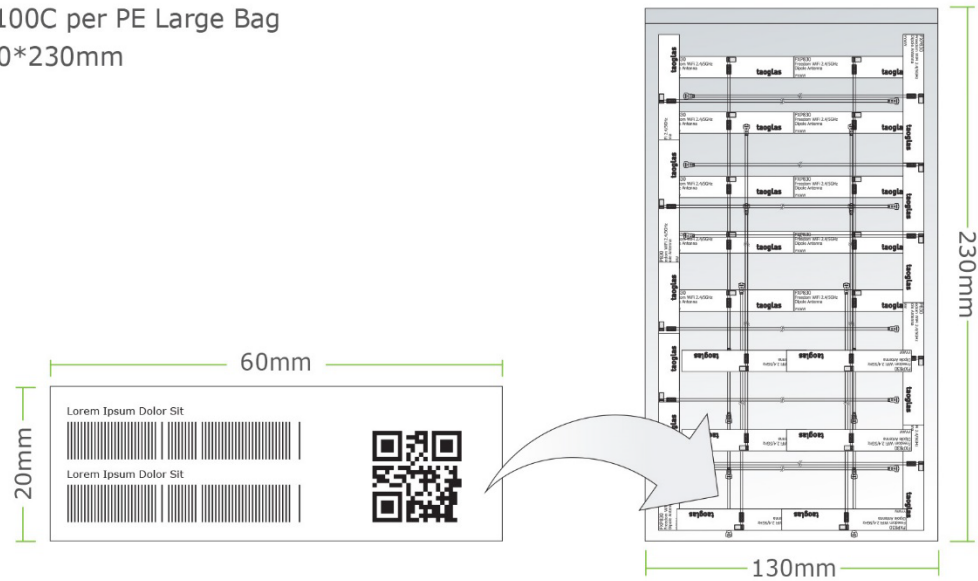

2,000 pcs FXP830.07.0100C per carton
 Carton - 230*175*160mm
 Weight - 1.6Kg

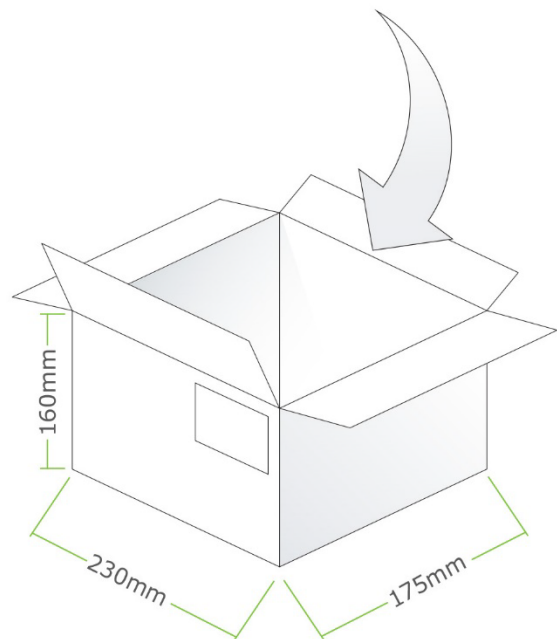

5. Antenna Characteristics

5.1 Test Setup

AUT



Vector Network Analyzer

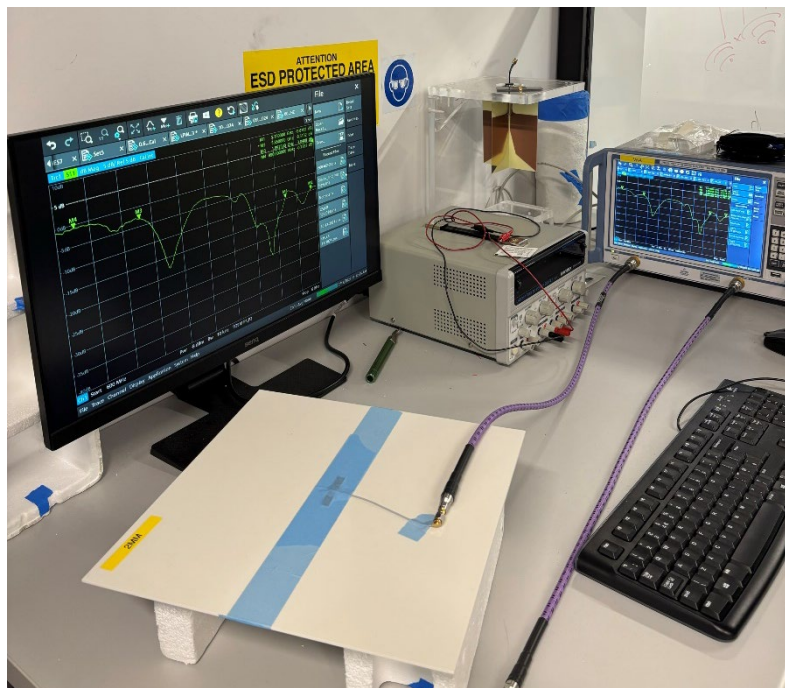

VNA Test Set-up on 2mm ABS

5.2 Return Loss

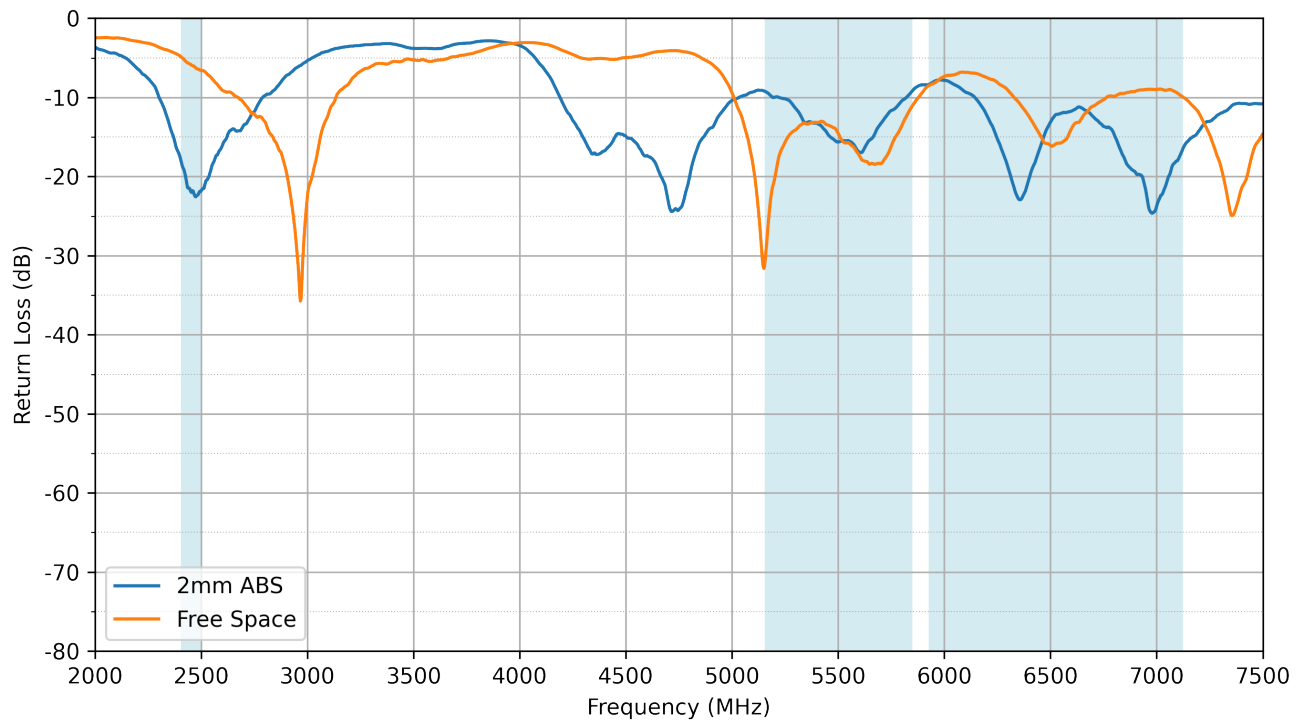

5.3 VSWR

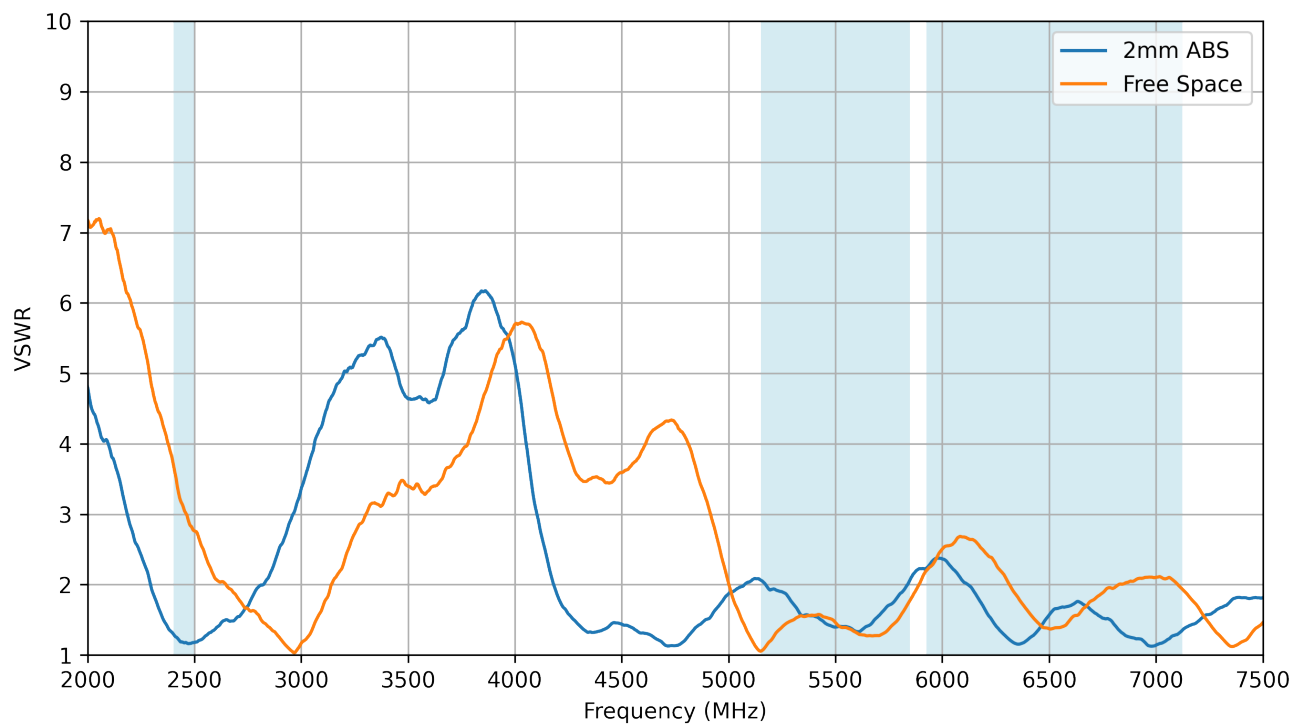

5.4 Efficiency

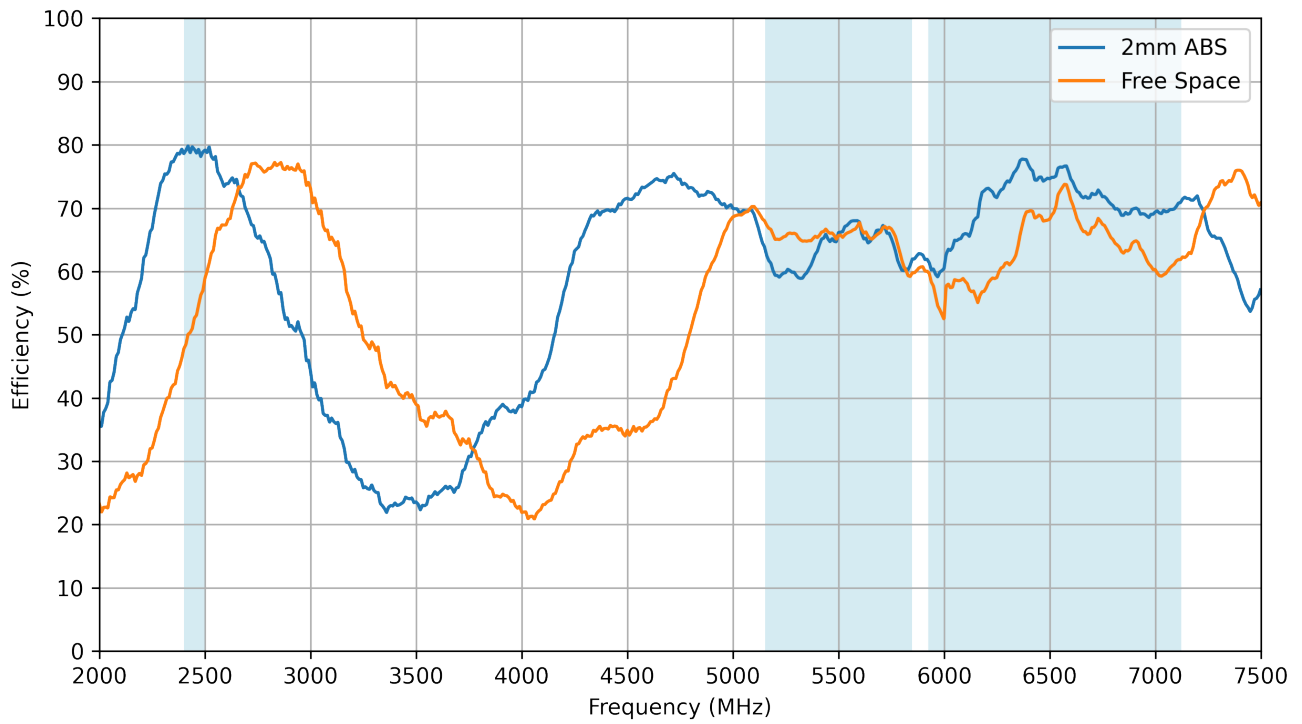

5.5 Average Gain

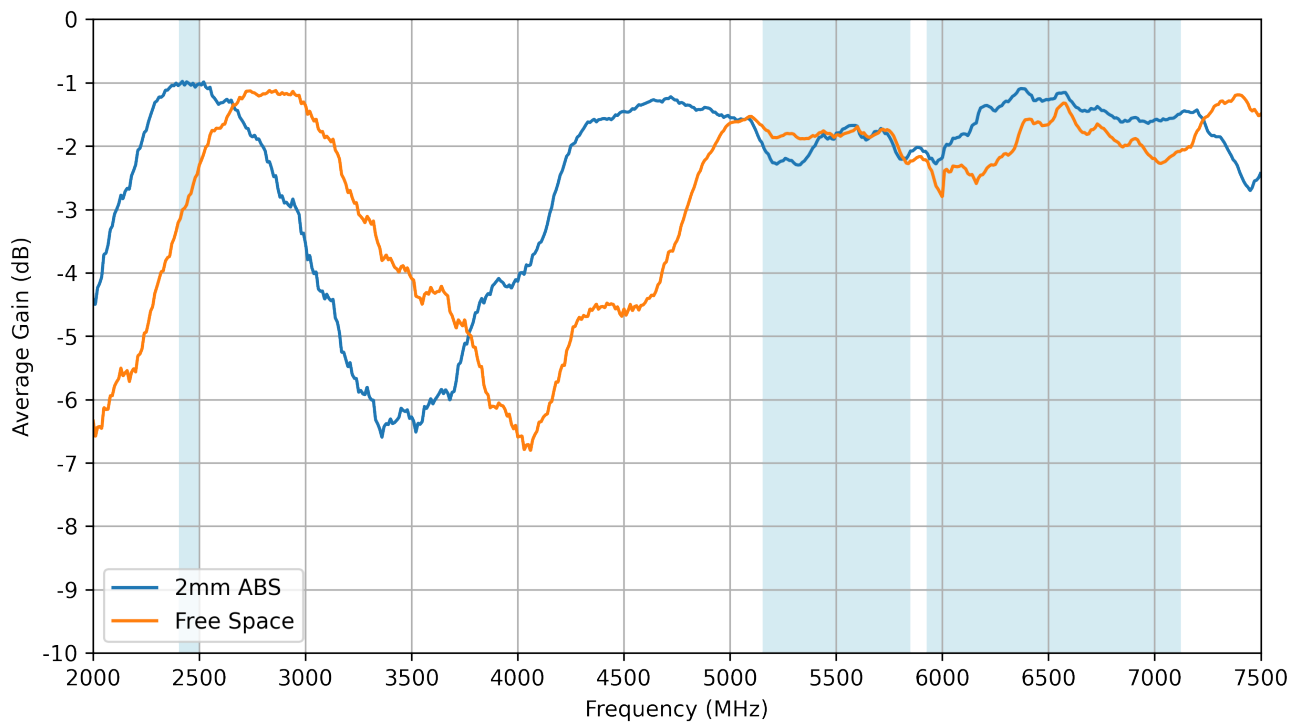

5.6 Peak Gain

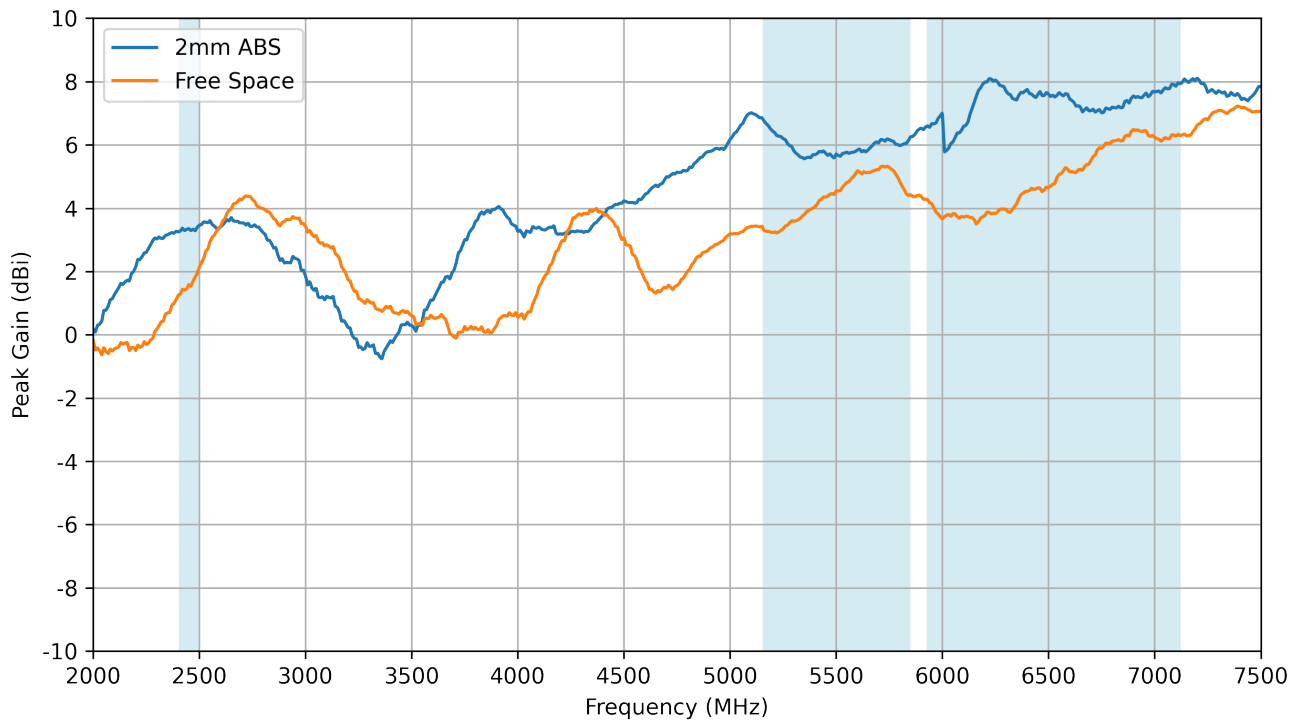

6. Radiation Patterns

6.1 Test Setup

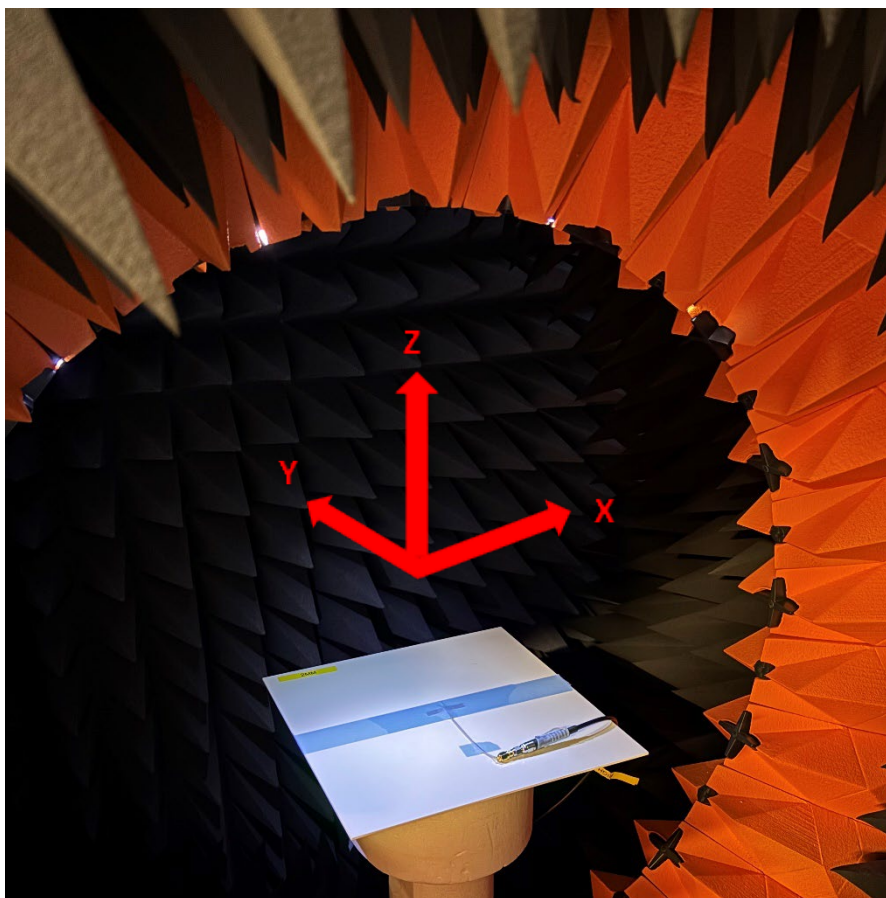
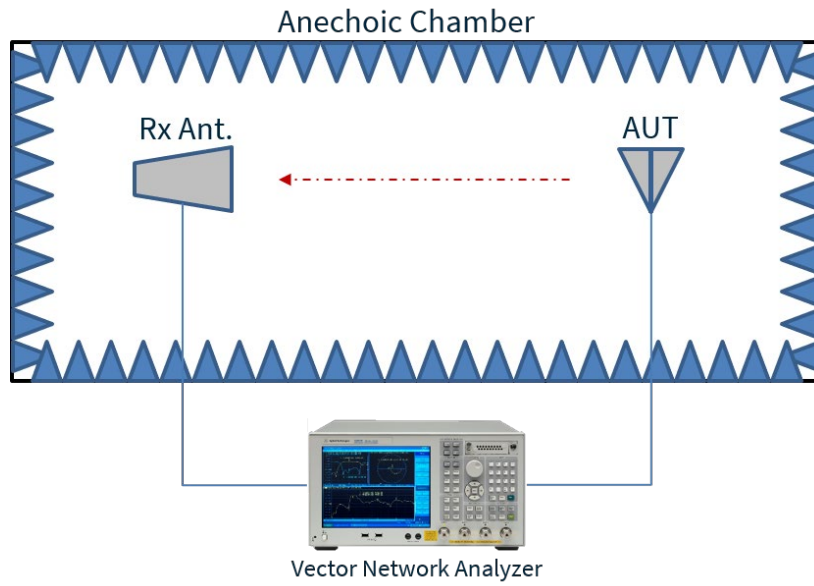

Chamber Test Set-up on 2mm ABS

6.2 2mm ABS Patterns at 2450 MHz

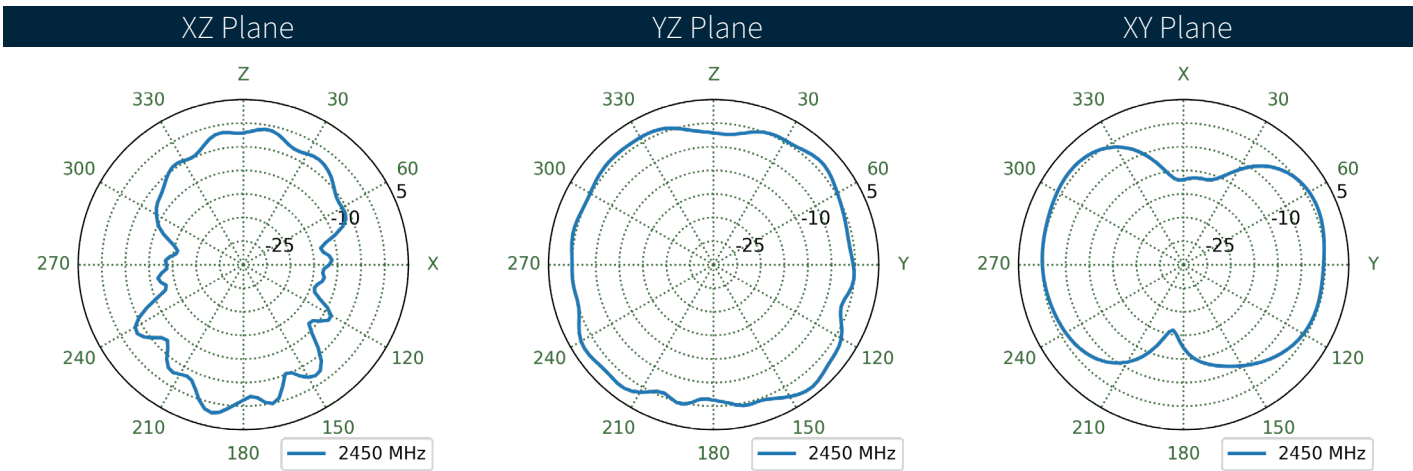
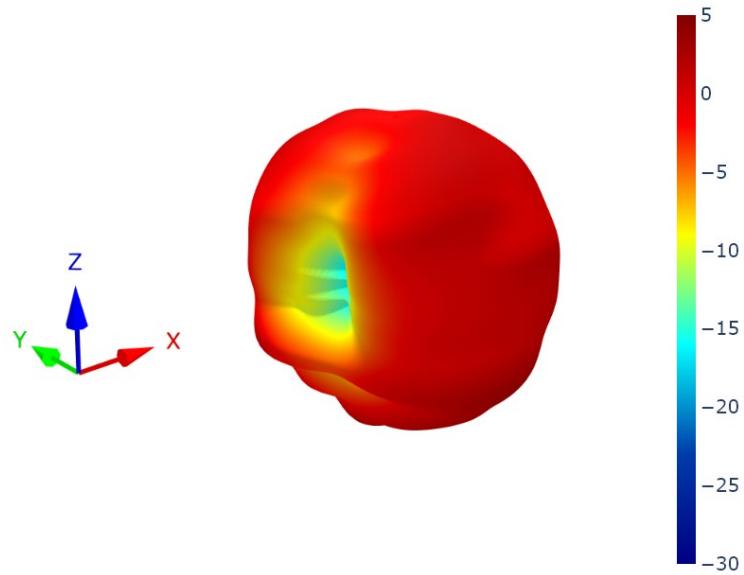

6.3 Free Space Patterns at 2450 MHz

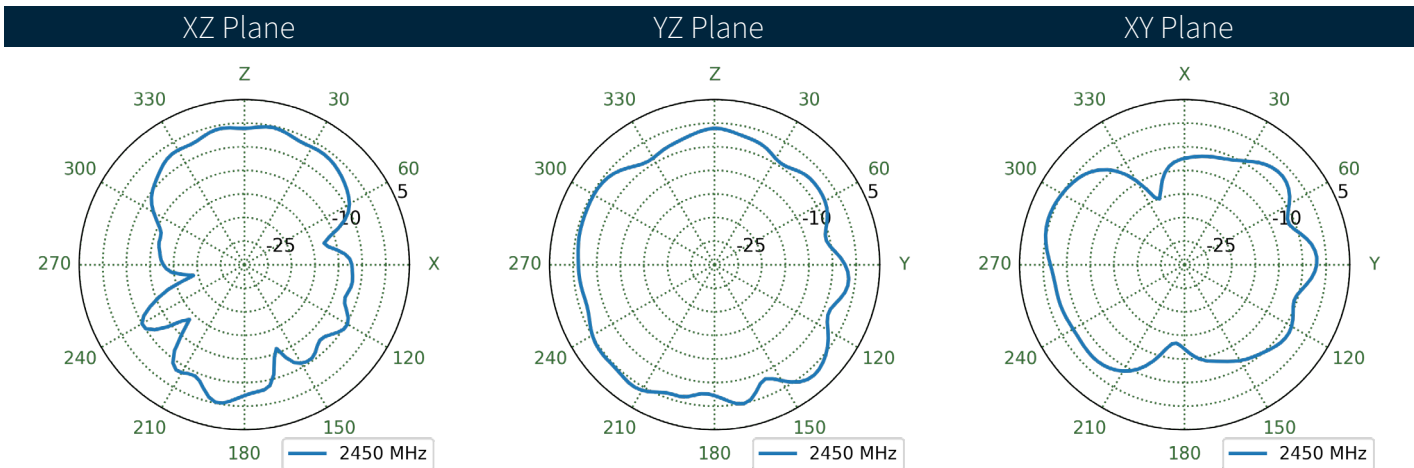
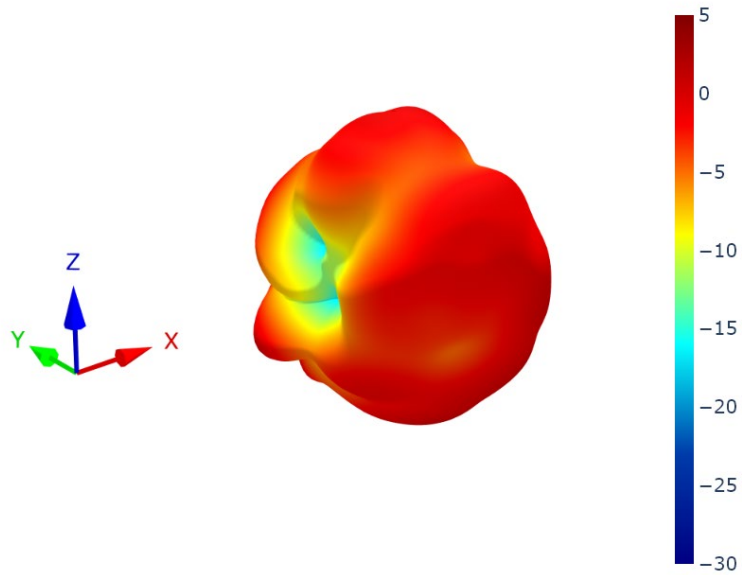

6.4 2mm ABS Patterns at 5500 MHz

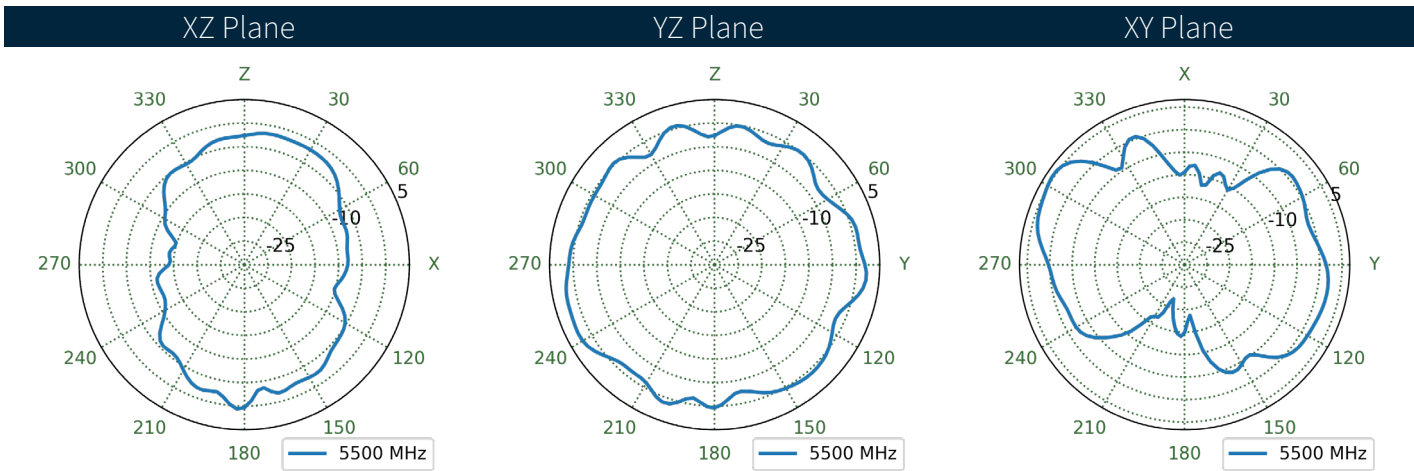
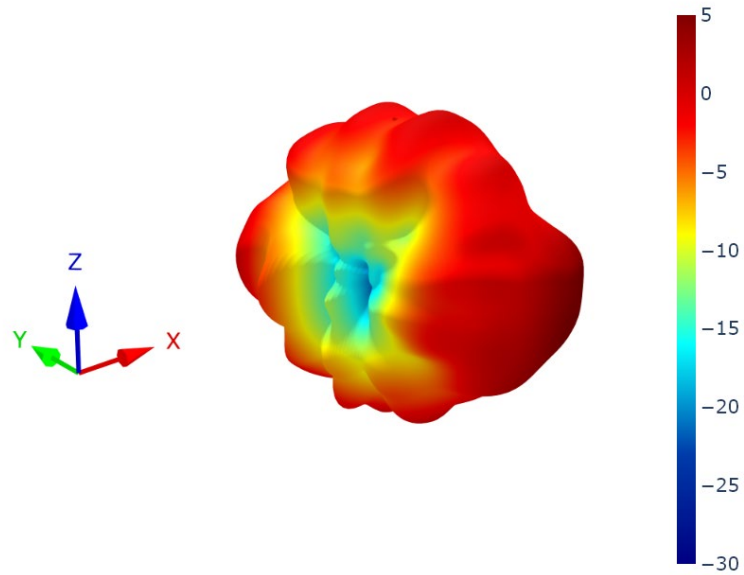

6.5 Free Space Patterns at 5500 MHz

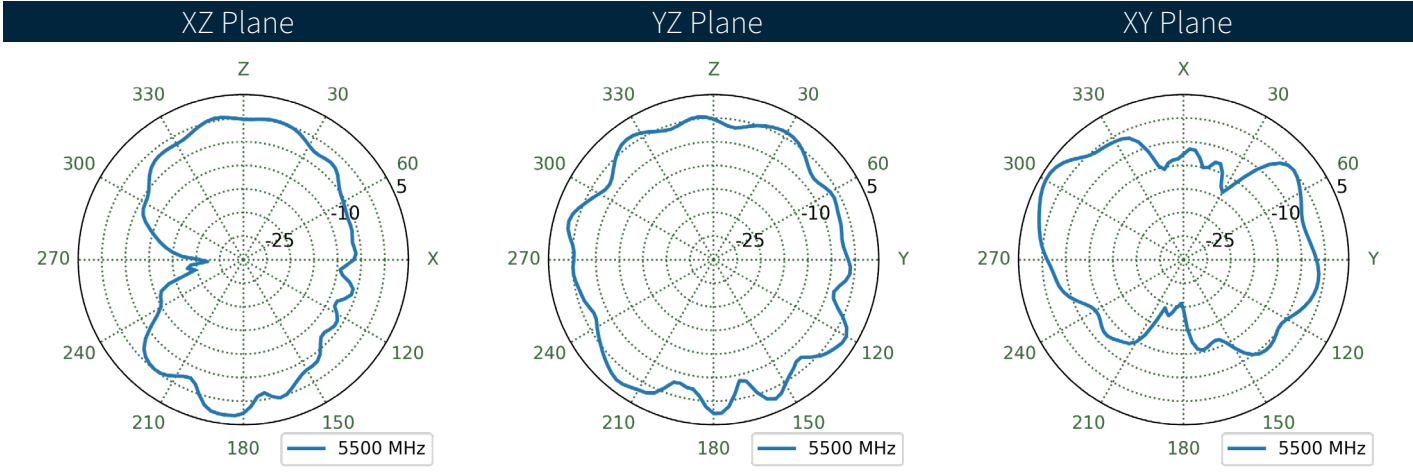
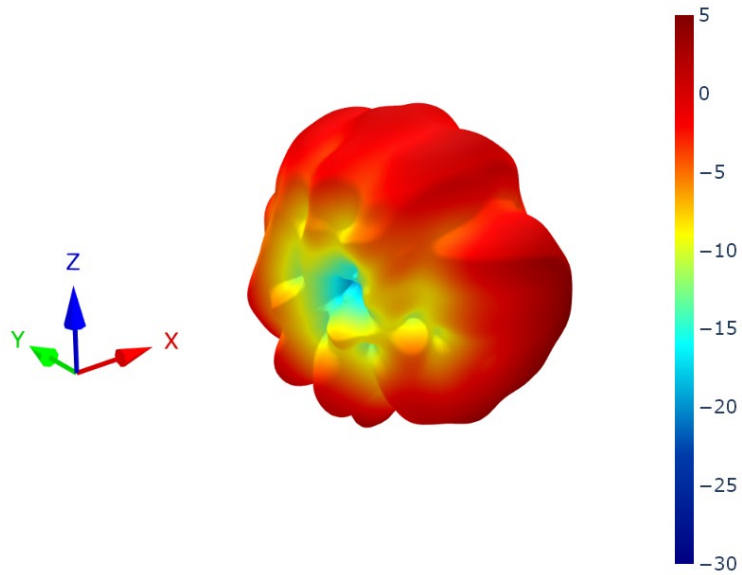

6.6 2mm ABS Patterns at 6520 MHz

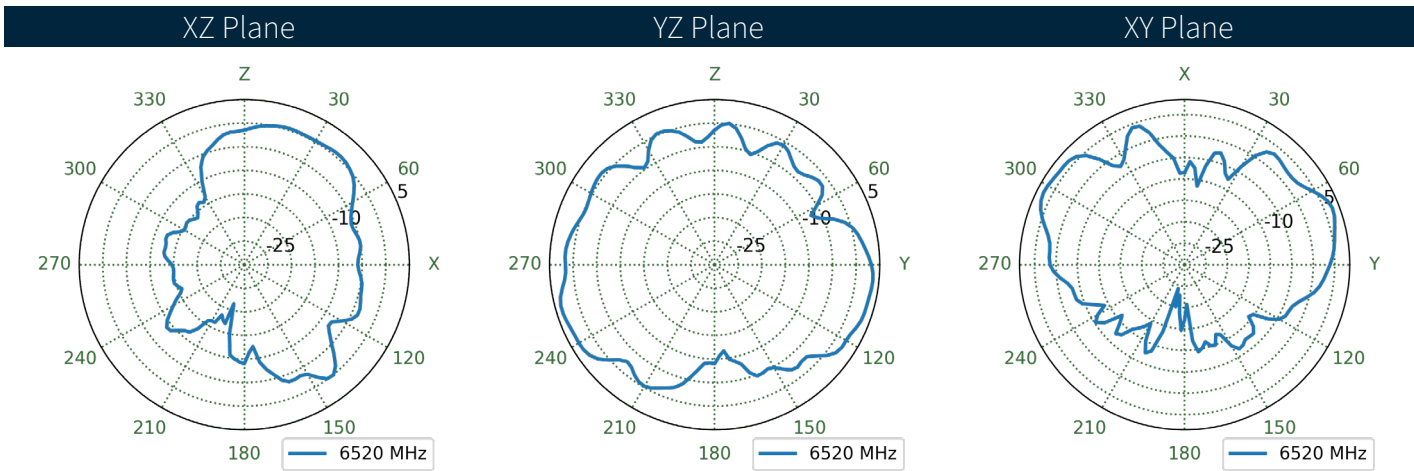
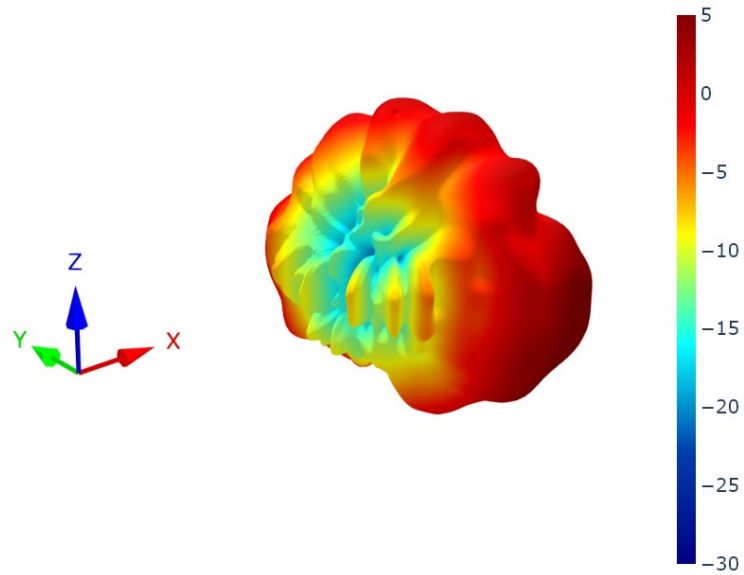

6.7 Free Space Patterns at 6520 MHz

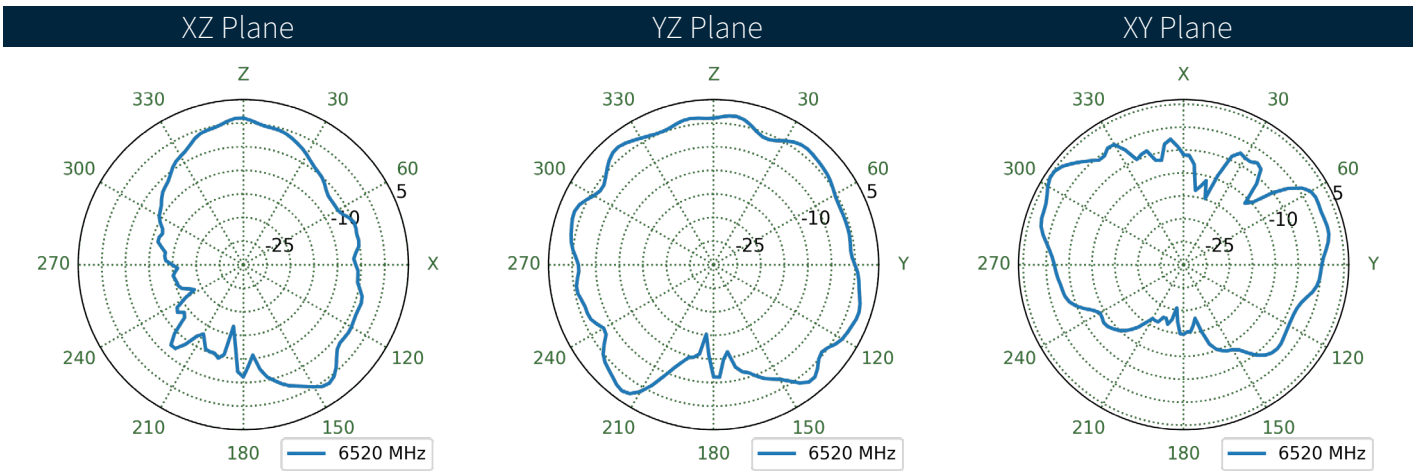
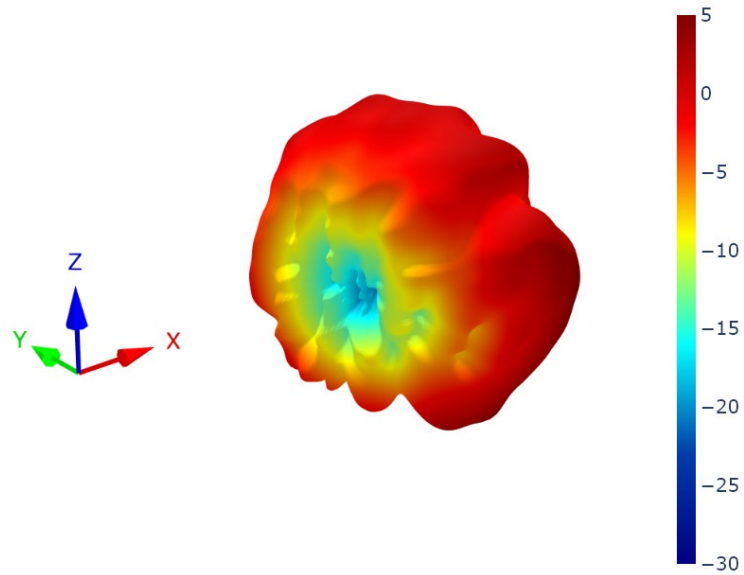

Changelog for the datasheet

SPE-11-8-037 – FXP830.07.0100C

Revision: M (Current Version)

Date:	2025-02-18
Changes:	Full datasheet update including Wi-Fi, Bluetooth, ZigBee Trademarking.
Changes Made by:	Gary West

Previous Revisions

Revision: L

Date:	2020-03-19
Changes:	Includes Wi-Fi 6 data
Changes Made by:	Jack Conroy

Revision: G

Date:	2017-06-06
Changes:	Drawing Updated
Changes Made by:	Peter Monahan

Revision: K

Date:	2019-11-14
Changes:	Updated Image and Drawing
Changes Made by:	Russell Meyler

Revision: F

Date:	2016-11-01
Changes:	Updated Peak Gain
Changes Made by:	Andy Mahoney

Revision: J

Date:	2019-03-01
Changes:	Packaging Details Updated
Changes Made by:	Jack Conroy

Revision: E

Date:	2016-02-12
Changes:	Updated Peak Gain
Changes Made by:	Andy Mahoney

Revision: I

Date:	2018-05-15
Changes:	Drawing Updated
Changes Made by:	David Connolly

Revision: D

Date:	2015-09-01
Changes:	Updated Average Gain
Changes Made by:	Aine Doyle

Revision: H

Date:	2017-10-19
Changes:	Packaging Details Updated
Changes Made by:	Carol Faughnan

Revision: C

Date:	2015-01-14
Changes:	Updated intro
Changes Made by:	Aine Doyle

Previous Revisions (Continued)

Revision: B	
Date:	2011-07-14
Changes:	
Changes Made by:	Aine Doyle

Revision: A (Original First Release)	
Date:	2011-01-20
Notes:	
Author:	Aine Doyle

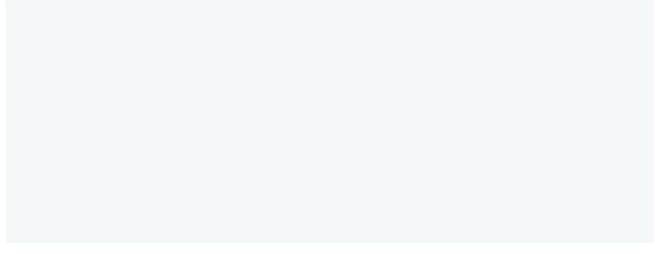
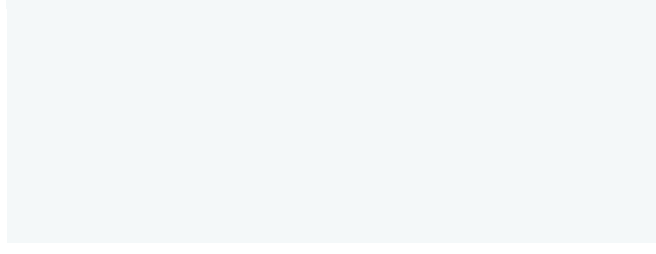
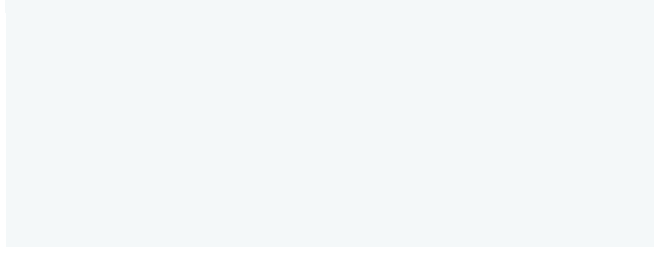
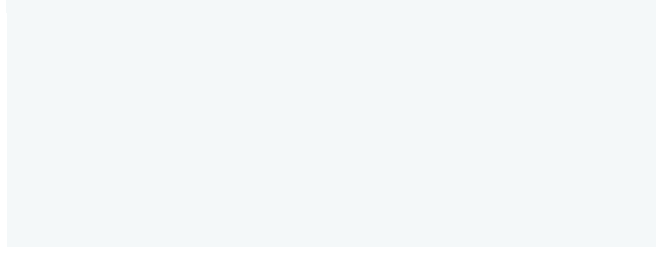
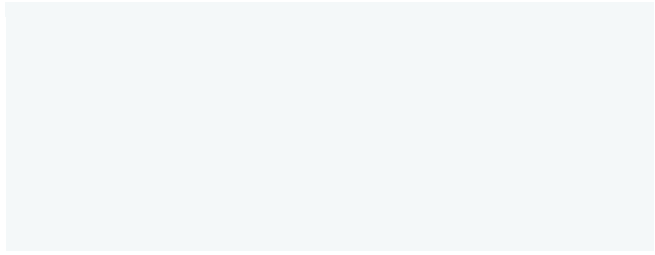
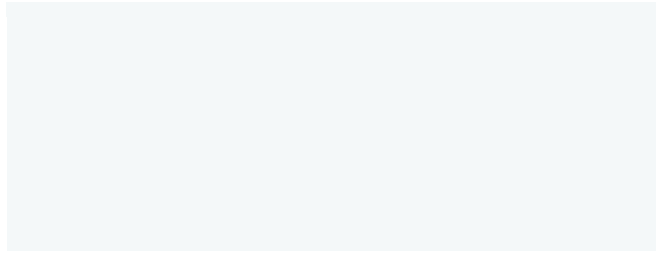
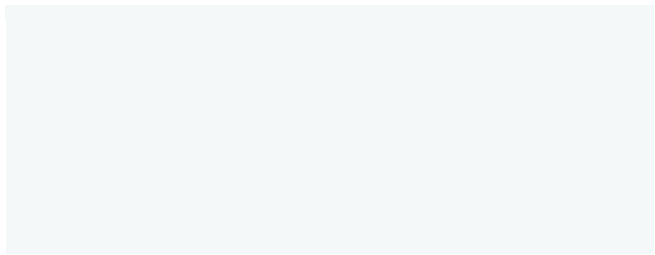
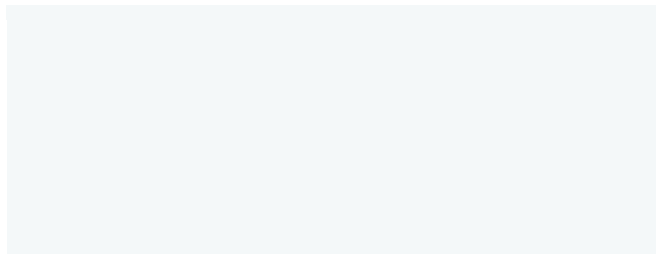



www.taoglas.com



Looking for pricing, stock, or lifecycle information?

Click below to explore more details on WIN SOURCE:

 [View FXP830.07.0100C on WIN SOURCE](#)

 [Taoglas Limited](#) Information

Optimize Your Supply Chain with WIN SOURCE Solutions

-  Global Sourcing Solution
-  Obsolete Management
-  Cost Control Management
-  Shortage Management
-  Alternative Solution
-  Excess Inventory Management