

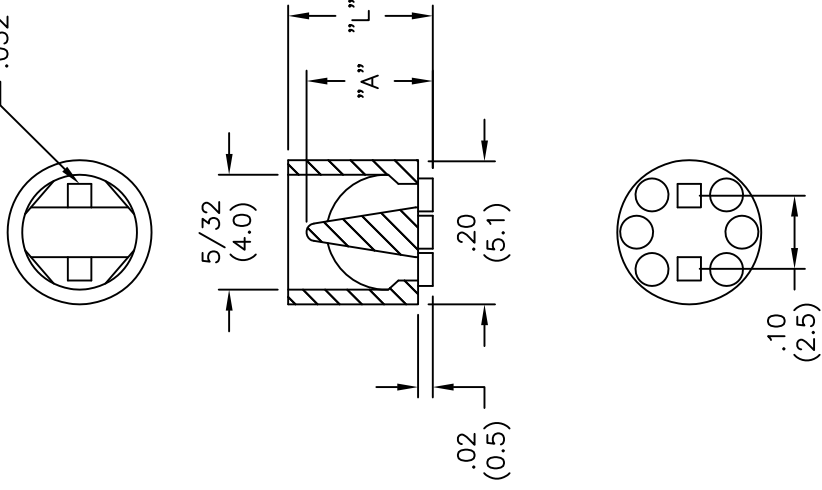

**THE DATASHEET OF
LEDS2M-750-01**



.032 (0.8) SQ.



NOTES:

1. MATERIAL: NYLON 6/6 UL 94 V-2 (RMS-01).
COLOR: NATURAL,
BLACK AVAILABLE BY SPECIAL ORDER.
2. FOR T-1 3/4 LED'S.

PART NUMBER	"L"
LEDS2M-120-01	.12
LEDS2M-140-01	.14
LEDS2M-160-01	.16
LEDS2M-180-01	.18
LEDS2M-200-01	.20
LEDS2M-220-01	.22
LEDS2M-240-01	.24
LEDS2M-250-01	.25
LEDS2M-260-01	.26
LEDS2M-280-01	.28
LEDS2M-300-01	.30
LEDS2M-320-01	.32
LEDS2M-340-01	.34
LEDS2M-360-01	.36
LEDS2M-380-01	.38
LEDS2M-400-01	.40
LEDS2M-420-01	.42
LEDS2M-440-01	.44
LEDS2M-450-01	.45
LEDS2M-460-01	.46
LEDS2M-500-01	.50
LEDS2M-550-01	.55
LEDS2M-600-01	.60
LEDS2M-650-01	.65
LEDS2M-750-01	.75
LEDS2M-850-01	.85
LEDS2M-900-01	.90

REV	DESCRIPTION	ENGR	DATE
H	SEE CO 200651 FOR CHANGES	SK	04.04.11
G	SEE CO 200649 FOR CHANGES	SK	04.01.11
F	SEE ECN #1168 FOR CHANGES	SK	05.19.06
E	SEE ECN #892 FOR CHANGES	SM	12.14.04
D	SEE ECN #547 FOR CHANGES	SM	12.20.02
C	SEE ECN #526 FOR CHANGES	SM	11.21.02
B	CHANGED DIM "A" (SEE ENGINEERING)	SM	11.01.01
A	CHANGED FILE NO. AND TITLE BLOCK	SM	10.03.01

TITLE:

LED SPACER

TOLERANCES
UNLESS NOTED
.XX=±.010
.XXX=±.005
FRAC=±1/64
ANG=±1°

FILE # LE DS2M
MAT'L: SEE NOTES

RE: RICHCO, INC.

DWN: D.D. APP:
DT: 05-20-96 IDT:

RICHCO INC.
PO BOX 804238, CHICAGO, 60688
(773) 539-4060

Looking for pricing, stock, or lifecycle information?

Click below to explore more details on WIN SOURCE:

 [View LEDS2M-750-01](#) on WIN SOURCE

 [Essentra Components](#) Information

Optimize Your Supply Chain with WIN SOURCE Solutions

-  Global Sourcing Solution
-  Obsolete Management
-  Cost Control Management
-  Shortage Management
-  Alternative Solution
-  Excess Inventory Management