



**THE DATASHEET OF
ABLS-LR-4.000MHZ-T**



HC/49US (AT49) ULTRA LOW ESR SMD LOW PROFILE CRYSTAL



11.5 x 4.8 x 4.2 mm

ABLS-LR



RoHS
Compliant

FEATURES:

- Ultra low ESR as low as 20 ohms for 4MHz, 85% lower than typical SMD Low Profile HC49S Crystals
- Low negative resistance(-R) IC design can ensure high oscillation margin
- Tight stability and automotive grade temperature available
- Hermetically resistance weld sealed

APPLICATIONS:

- Low negative resistance u-controller design for low frequency
- Wide range of automotive applications
- Industrial applications

STANDARD SPECIFICATIONS:

PARAMETERS	
ABRACON P/N	ABLS-LR Series
Frequency	3.0 MHz to 36 MHz
Operation Mode	AT cut (Fundamental)
Operating Temperature	0°C to +70°C (see options)
Storage Temperature	-55°C to +125°C
Frequency Tolerance	± 50 ppm max. (see options)
Frequency Stability over the Operating Temp. (Ref to +25°C)	3.0 ~ 3.579545MHz: ± 100 ppm max. (Standard only*) *Please contact ABRACON for other stability specs. 3.579545 ~ 36MHz: ± 50 ppm max. (see options)
Equivalent Series Resistance (R1)	See Table 1
Shunt Capacitance C ₀	7pF max.
Load Capacitance C _L	18pF (see options)
Drive Level	1 mW max., 100µW typical
Aging at 25°C Per Year	± 5ppm max.
Insulation Resistance	500 MΩ min at 100Vdc ± 15V
Spurious Responses	-3dB max.
Drive level dependency (DLD)	from 1µW to 500µW (minimum 7 points tested)

TABLE 1: ESR

FREQUENCY (MHz)	ESR (?) Max.
3.000000	100
3.072000	100
3.276800	75
3.500000 - 4.000000	40
4.000001 - 4.500000	25
4.500001 - 6.999999	20
7.000000 - 12.999999	15
13.000000 - 30.000000	10

OPTIONS & PART IDENTIFICATION:

(Left blank if standard)

ABLS - LR - [] MHz - [] - [] - [] - []

Frequency in MHz
e.g. 3.579545MHz
14.31818MHz
24.000MHz

Load Capacitance
Please specify CL in pF
or S for Series (10pF
minimum)

Operating Temp.
A: -10°C ~ +60°C
B: -20°C ~ +70°C
C: -30°C ~ +70°C
N: -30°C ~ +85°C
D: -40°C ~ +85°C
J(*): -40°C to +105°C
K(*): -40°C to +125°C
L(*): -55°C to +125°C

Freq. Tolerance
H5: ± 5 ppm
1: ± 10 ppm
7: ± 15 ppm
2: ± 20 ppm
3: ± 25 ppm
4: ± 30 ppm

Freq. Stability
U(**): ± 10 ppm
G: ± 15 ppm
X: ± 20 ppm
W: ± 25 ppm
Y: ± 30 ppm
H: ± 35 ppm
Q: ± 100 ppm
R: ± 150 ppm

Packaging
Blank: Bulk
T: Tape & Reel

* Frequency stability R option (±150ppm) only.
Contact ABRACON for tighter frequency stability.
** -10 to +60°C only.



HC/49US (AT49) ULTRA LOW ESR SMD LOW PROFILE CRYSTAL



11.5 x 4.8 x 4.2 mm

ABLS-LR



RoHS
Compliant

OUTLINE DRAWING:

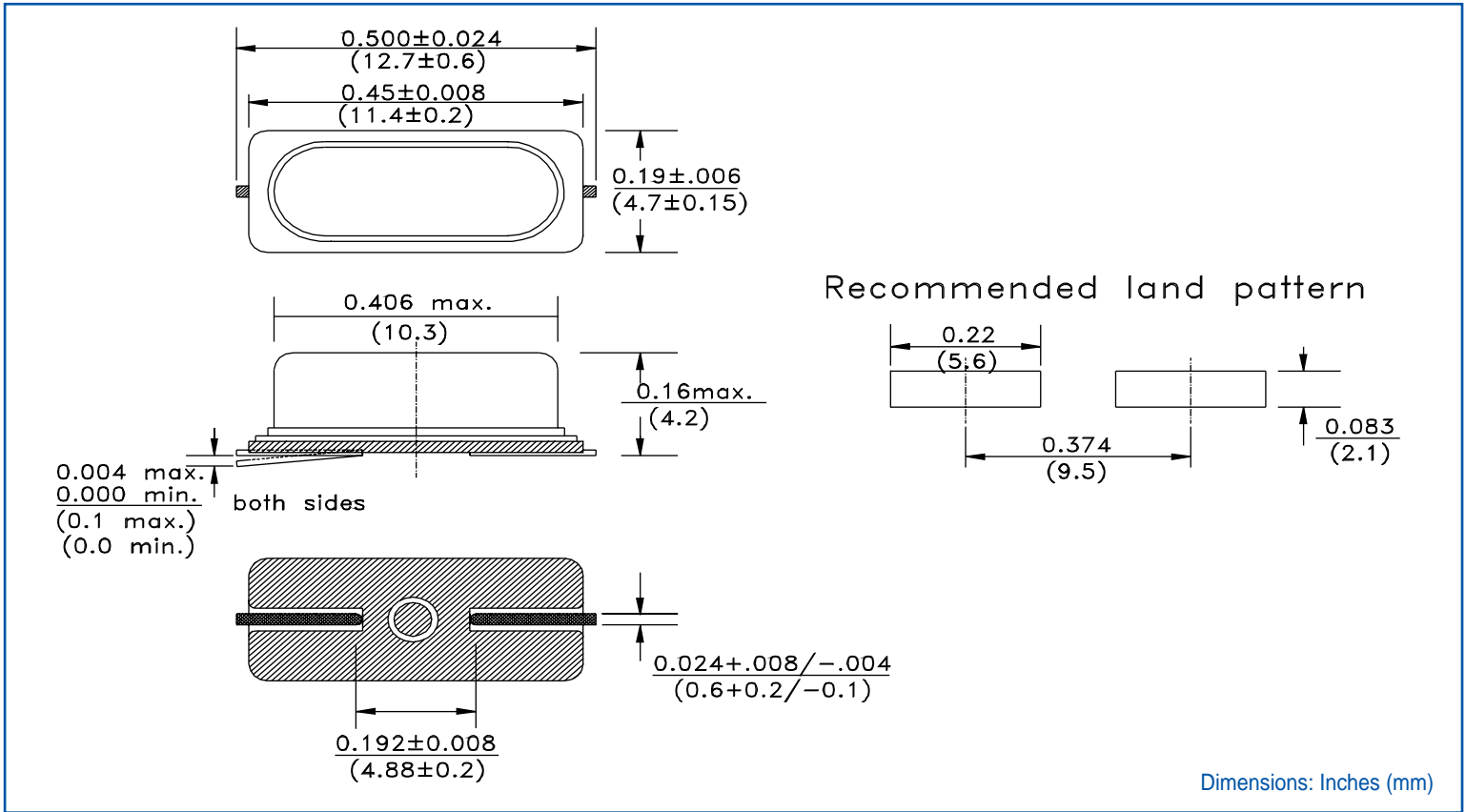

TAPE & REEL: T= tape and reel (1,000pcs/reel)

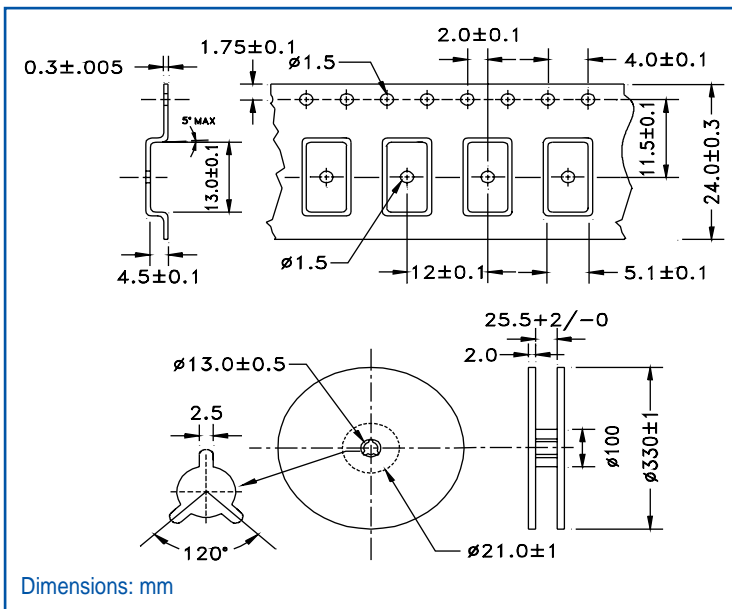

REFLOW PROFILE:

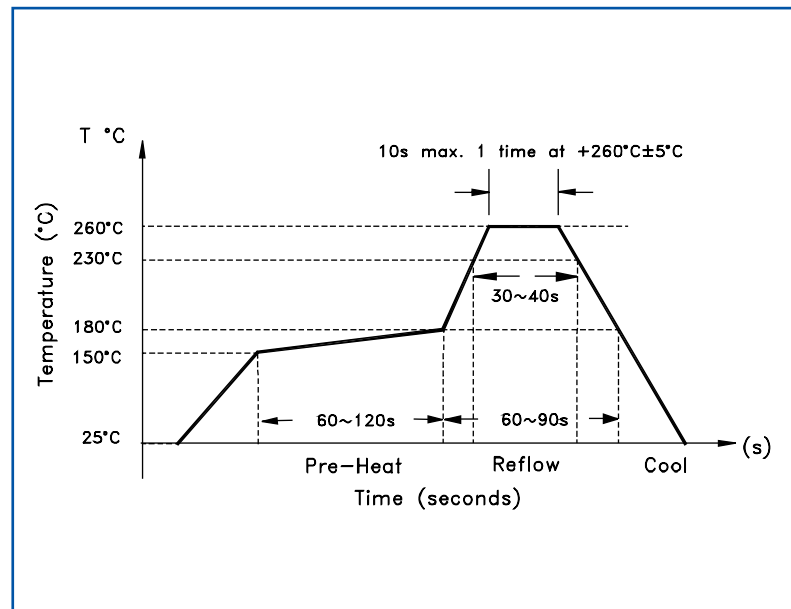

ATTENTION: Abracon Corporation's products are COTS – Commercial-Off-The-Shelf products; suitable for Commercial, Industrial and, where designated, Automotive Applications. Abracon's products are not specifically designed for Military, Aviation, Aerospace, Life-dependant Medical applications or any application requiring high reliability where component failure could result in loss of life and/or property. For applications requiring high reliability and/or presenting an extreme operating environment, written consent and authorization from Abracon Corporation is required. Please contact Abracon Corporation for more information.

ABRACON IS
ISO9001:2008
CERTIFIED



Visit www.abracon.com for Terms & Conditions of Sale **Revised: 11.30.10**
30332 Esperanza, Rancho Santa Margarita, California 92688
tel 949-546-8000 | fax 949-546-8001 | www.abracon.com

Looking for pricing, stock, or lifecycle information?

Click below to explore more details on WIN SOURCE:

- ⊖ [View ABL5-LR-4.000MHZ-T on WIN SOURCE](#)
- ⊖ [Abracon LLC Information](#)

Optimize Your Supply Chain with WIN SOURCE Solutions

- ✓ Global Sourcing Solution
- ✓ Obsolete Management
- ✓ Cost Control Management
- ✓ Shortage Management
- ✓ Alternative Solution
- ✓ Excess Inventory Management