



**THE DATASHEET OF**  
**0034.7306**



Subminiature Fuse, 8.5 mm, Time-Lag T, 250 VAC, cULus



Subminiature fuse 8.5 mm, time-lag T,  
250 VAC  
Short terminal  
PCB



Subminiature fuse 8.5 mm, time-lag T,  
250 VAC  
Terminal long  
PCB

UL 248-14 · 250 VAC · Time-Lag T

See below:

[Approvals and Compliances](#)**Description**

- Directly solderable on printed circuit boards
- Low Breaking Capacity

**References**

Last order date: 30.04.2026

Last delivery date: 31.07.2026

**Weblinks**

[pdf data sheet](#), [html datasheet](#), [General Product Information](#), [Distributor-Stock-Check](#), [Detailed request for product](#)

**Technical Data**

Rated Voltage	250 VAC	Soldering Methods	Wave <a href="#">Soldering Profile</a>
Rated current	0.063 - 10 A	Solderability	235 °C / 2 sec acc. to IEC 60068-2-20, Test Ta
Breaking Capacity	50 A	Resistance to Soldering Heat	260 °C / 10 sec acc. to IEC 60068-2-20, Test Tb
Characteristic	Time-Lag T	Case Resistance	acc. to EIA/IS-722, Test 4.7 >100 MΩ (between leads and body)
Mounting	PCB, THT	Flammability	UL 94V-0 (acc. to EIA/IS-722, Test 4.12)
Admissible Ambient Temp.	-40 °C to 85 °C	Current Carrying Capacity	acc. to EIA/IS-722, Test 4.3.3
Climatic Category	40/085/21 acc. to IEC 60068-1	Moisture Sensitivity Level	MIL-STD-202, Method 106 (50 cycles in a temp./mister chamber)
Material: Housing	Thermoplastic, UL 94V-0	Vibration, High Frequency	MIL-STD-202, Method 204 Condition D
Material: Terminals	Tin-Plated Copper	Mechanical Shock	(acc. to EIA/IS-722, Test 4.9)
Unit Weight	0.53 g	Resistance to Solvents	MIL-STD-202, Method 215
Storage Conditions	0 °C to 40 °C, max. 70% r.h.	Terminal Strength	MIL-STD-202, Method 211A (Deflection of board 1 mm for 1 minute)
Product Marking	 Type, Rated current, Rated Voltage, Characteristic, Certification marks		

**Approvals and Compliances**

Detailed information on product approvals, code requirements, usage instructions and detailed test conditions can be looked up in [Details about Approvals](#)

SCHURTER products are designed for use in industrial environments. They have approvals from independent testing bodies according to national and international standards. Products with specific characteristics and requirements such as required in the automotive sector according to IATF 16949, medical technology according to ISO 13485 or in the aerospace industry can be offered exclusively with customer-specific, individual agreements by SCHURTER.

**Approvals**



The approval mark is used by the testing authorities to certify compliance with the safety requirements placed on electronic products.

Approval Reference Type: MSTU 250

Approval Logo	Certificates	Certification Body	Description
	<a href="#">UL Approvals</a>	UL	UL File Number: E41599

## Product standards

Product standards that are referenced

Organization	Design	Standard	Description
	Designed according to	UL 248-14	Low voltage fuses - Part 14: Supplemental fuses
	Designed according to	CSA22.2 No. 248.14	Low-Voltage Fuses - Part 14: Supplemental Fuses





## Application standards

Application standards where the product can be used

Organization	Design	Standard	Description
	Suitable for applications acc.	IEC/UL 62368-1	Audio/video, information and communication technology equipment - Part 1: Safety requirements

## Compliances

The product complies with following Guide Lines

Identification	Details	Initiator	Description
	<a href="#">CE declaration of conformity</a>	SCHURTER AG	The CE marking declares that the product complies with the applicable requirements laid down in the harmonisation of Community legislation on its affixing in accordance with EU Regulation 765/2008.
	<a href="#">UKCA declaration of conformity</a>	SCHURTER AG	The UKCA marking declares that the product complies with the applicable requirements laid down in the British Amendment of Regulation (EC) 765/2008.
	RoHS	SCHURTER AG	Directive RoHS 2011/65/EU, Amendment (EU) 2015/863
	China RoHS	SCHURTER AG	The law SJ / T 11363-2006 (China RoHS) has been in force since 1 March 2007. It is similar to the EU directive RoHS.
	REACH	SCHURTER AG	On 1 June 2007, Regulation (EC) No 1907/2006 on the Registration, Evaluation, Authorization and Restriction of Chemicals 1 (abbreviated as "REACH") entered into force.

## Dimension [mm]

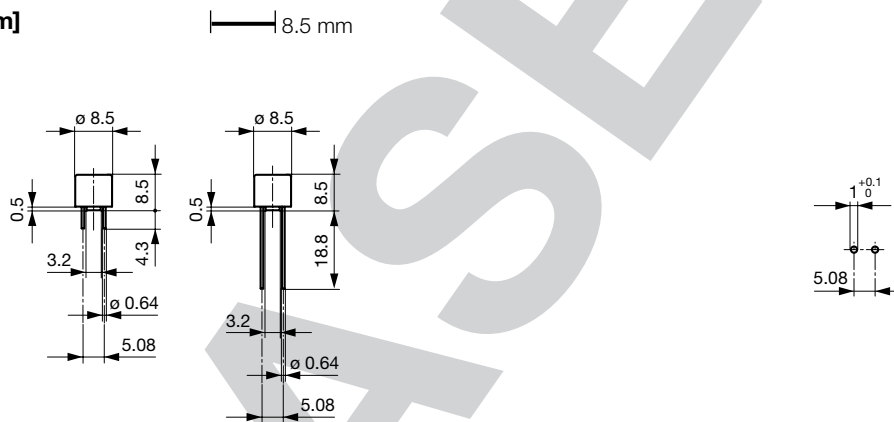

Drilling diagram

## Pre-Arcing Time

Rated Current In	1.0 x In min.	2.0 x In max.
0.063 A - 10 A	4 h	120 s

Time-Current-Curves

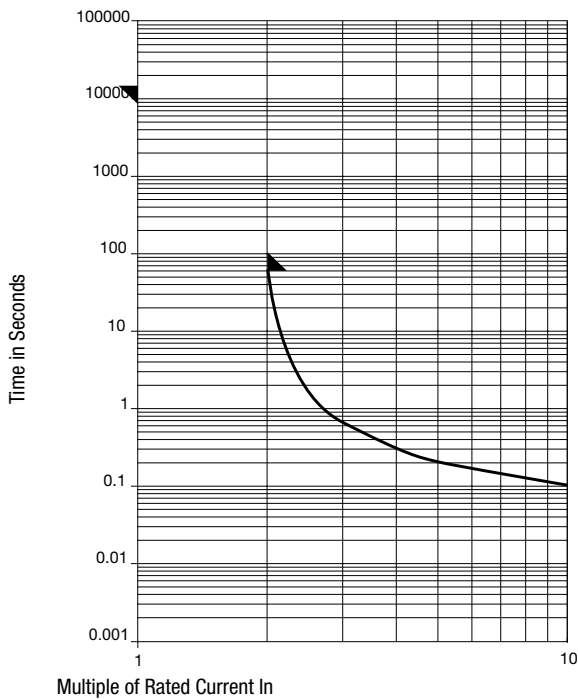

Variants

Rated Current [A]	Rated Voltage [VAC]	Breaking Capacity	Voltage Drop 1.0 I <sub>n</sub> typ. [mV]	Power Dissipation 1.0 I <sub>n</sub> typ. [mW]	Melting I <sup>2</sup> t 10.0 I <sub>n</sub> typ. [A <sup>2</sup> s]	c(U) <sub>US</sub>	S	L	T	Order Number
0.063	250	1)	544	37	0.0176	●	●			0034.7103
0.08	250	1)	413	38	0.0313	●	●			0034.7104
0.1	250	1)	318	35	0.0456	●	●			0034.7105
0.125	250	1)	289	40	0.0567	●	●			0034.7106
0.16	250	1)	219	38	0.0692	●	●			0034.7107
0.2	250	1)	262	60	0.133	●	●			0034.7108
0.25	250	1)	202	55	0.258	●	●			0034.7109
0.315	250	1)	168	49	0.361	●	●			0034.7110
0.4	250	1)	159	69	0.528	●	●			0034.7111
0.5	250	1)	143	78	0.898	●	●			0034.7112
0.63	250	1)	124	85	2.24	●	●			0034.7113
0.8	250	1)	114	98	4.05	●	●			0034.7114
1	250	1)	100	107	6.85	●	●			0034.7115
1.25	250	1)	94	127	7.93	●	●			0034.7116
1.6	250	1)	85	145	17.5	●	●			0034.7117
2	250	1)	80	175	28.6	●	●			0034.7118
2.5	250	1)	75	205	40.9	●	●			0034.7119
3.15	250	1)	71	240	55	●	●			0034.7120
4	250	1)	72	303	67.2	●	●			0034.7121
5	250	1)	70	376	142	●	●			0034.7122
6.3	250	1)	68	488	287	●	●			0034.7123
8	250	1)	50	445	422	●	●			0034.7124
10	250	1)	50	630	564	●	●			0034.7125
0.063	250	1)	544	37	0.0176	●		●		0034.7203
0.08	250	1)	413	38	0.0313	●		●		0034.7204
0.1	250	1)	318	35	0.0456	●		●		0034.7205
0.125	250	1)	289	40	0.0567	●		●		0034.7206

Rated Current [A]	Rated Voltage [VAC]	Breaking Capacity	Voltage Drop 1.0 I <sub>n</sub> typ. [mV]	Power Dissipation 1.0 I <sub>n</sub> typ. [mW]	Melting I <sup>2</sup> t 10.0 I <sub>n</sub> typ. [A <sup>2</sup> s]		S	L	T	Order Number
0.16	250	1)	219	38	0.0692	●	●			0034.7207
0.2	250	1)	262	60	0.133	●	●			0034.7208
0.25	250	1)	202	55	0.258	●	●			0034.7209
0.315	250	1)	168	49	0.361	●	●			0034.7210
0.4	250	1)	159	69	0.528	●	●			0034.7211
0.5	250	1)	143	78	0.898	●	●			0034.7212
0.63	250	1)	124	85	2.24	●	●			0034.7213
0.8	250	1)	114	98	4.05	●	●			0034.7214
1	250	1)	100	107	6.85	●	●			0034.7215
1.25	250	1)	94	127	7.93	●	●			0034.7216
1.6	250	1)	85	145	17.5	●	●			0034.7217
2	250	1)	80	175	28.6	●	●			0034.7218
2.5	250	1)	75	205	40.9	●	●			0034.7219
3.15	250	1)	71	240	55	●	●			0034.7220
4	250	1)	72	303	67.2	●	●			0034.7221
5	250	1)	70	376	142	●	●			0034.7222
6.3	250	1)	68	488	287	●	●			0034.7223
8	250	1)	50	445	422	●	●			0034.7224
10	250	1)	50	630	564	●	●			0034.7225
0.063	250	1)	544	37	0.0176	●		●		0034.7303
0.08	250	1)	413	38	0.0313	●		●		0034.7304
0.1	250	1)	318	35	0.0456	●		●		0034.7305
0.125	250	1)	289	40	0.0567	●		●		0034.7306
0.16	250	1)	219	38	0.0692	●		●		0034.7307
0.2	250	1)	262	60	0.133	●		●		0034.7308
0.25	250	1)	202	55	0.258	●		●		0034.7309
0.315	250	1)	168	49	0.361	●		●		0034.7310
0.4	250	1)	159	69	0.528	●		●		0034.7311
0.5	250	1)	143	78	0.898	●		●		0034.7312
0.63	250	1)	124	85	2.24	●		●		0034.7313
0.8	250	1)	114	98	4.05	●		●		0034.7314
1	250	1)	100	107	6.85	●		●		0034.7315
1.25	250	1)	94	127	7.93	●		●		0034.7316
1.6	250	1)	85	145	17.5	●		●		0034.7317
2	250	1)	80	175	28.6	●		●		0034.7318
2.5	250	1)	75	205	40.9	●		●		0034.7319
3.15	250	1)	71	240	55	●		●		0034.7320
4	250	1)	72	303	67.2	●		●		0034.7321
5	250	1)	70	376	142	●		●		0034.7322
6.3	250	1)	68	488	287	●		●		0034.7323
8	250	1)	50	445	422	●		●		0034.7324
10	250	1)	50	630	564	●		●		0034.7325

Availability for all products can be searched real-time: <https://www.schurter.com/en/info-center/support-tools/stock-check-distributors>

1) 50 A @ 250 VAC, cos φ = 0.95 - 1.0

### Packaging Unit

acc. IEC 60286-2

S = 4.3 mm	100 pcs in ESD-plastic bag
L = 18.8 mm	100 St. (Bulk)
T = 18.8 mm	750 pcs. in tape [P = P0: 12.7; P1: 3.81; H1: 26.45] on reel [A: 360; W3: 40; W4: 52; C: 30.5]

## Looking for pricing, stock, or lifecycle information?

Click below to explore more details on WIN SOURCE:

 [View 0034.7306 on WIN SOURCE](#)

 [Schurter Inc. Information](#)

## Optimize Your Supply Chain with WIN SOURCE Solutions

-  Global Sourcing Solution
-  Obsolete Management
-  Cost Control Management
-  Shortage Management
-  Alternative Solution
-  Excess Inventory Management