



**THE DATASHEET OF
MAX9944ATA+T**



General Description

The MAX9943/MAX9944 is a family of high-voltage amplifiers that offers precision, low drift, and low-power consumption.

The MAX9943 (single) and MAX9944 (dual) op amps offer 2.4MHz of gain-bandwidth product with only 550 μ A of supply current per amplifier.

The MAX9943/MAX9944 family has a wide power supply range operating from ± 3 V to ± 19 V dual supplies or a 6V to 38V single supply.

The MAX9943/MAX9944 is ideal for sensor signal conditioning, high-performance industrial instrumentation and loop-powered systems (e.g., 4mA–20mA transmitters).

The MAX9943 is offered in a space-saving 6-pin TDFN or 8-pin μ MAX[®] package. The MAX9944 is offered in an 8-pin SO or an 8-pin TDFN package. These devices are specified over the -40°C to $+125^{\circ}\text{C}$ automotive temperature range.

Applications

- Sensor Interfaces
- Loop-Powered Systems
- Industrial Instrumentation
- High-Voltage ATE
- High-Performance ADC/DAC Input/Output Amplifiers

μ MAX is a registered trademark of Maxim Integrated Products, Inc.

Features

- Wide 6V to 38V Supply Range
- Low 100 μ V (max) Input Offset Voltage
- Low 0.4 μ V/ $^{\circ}\text{C}$ Offset Drift
- Unity Gain Stable with 1nF Load Capacitance
- 2.4MHz Gain-Bandwidth Product
- 550 μ A Supply Current
- 20mA Output Current
- Rail-to-Rail Output
- Package Options
 - 3mm x 5mm, 8-Pin μ MAX or 3mm x 3mm, 6-Pin TDFN Packages (Single)
 - 5mm x 6mm, 8-Pin SO or 3mm x 3mm, 8-Pin TDFN Packages (Dual)

Pin Configurations appear at end of data sheet.

Capacitive Load vs. Resistive Load

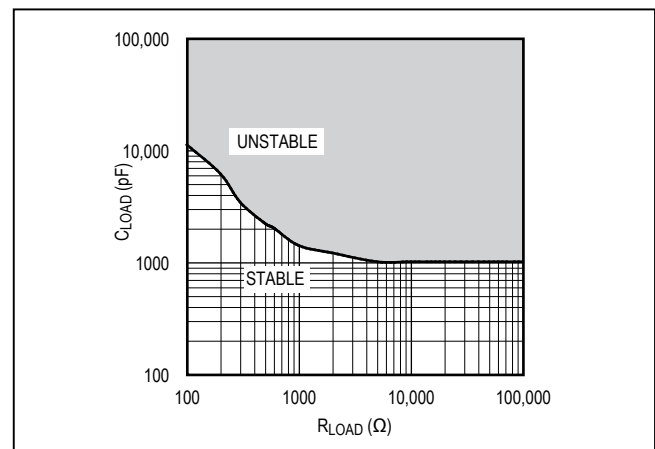

Absolute Maximum Ratings

Supply Voltage (V_{CC} to V_{EE})-0.3V to +40V
 All Other Pins (Note 1)($V_{EE} - 0.3V$) to ($V_{CC} + 0.3V$)
 OUT Short-Circuit Current Duration

8-Pin μ MAX ($V_{CC} - V_{EE} \leq 20V$) 3s
 8-Pin μ MAX ($V_{CC} - V_{EE} > 20V$) Momentary
 6-Pin TDFN ($V_{CC} - V_{EE} \leq 20V$)60s
 6-Pin TDFN ($V_{CC} - V_{EE} > 20V$)2s
 8-Pin SO ($V_{CC} - V_{EE} \leq 20V$)60s
 8-Pin SO ($V_{CC} - V_{EE} > 20V$)2s
 8-Pin TDFN ($V_{CC} - V_{EE} \leq 20V$)60s
 8-Pin TDFN ($V_{CC} - V_{EE} > 20V$)2s

Continuous Input Current (Any Pins) $\pm 20mA$
 Thermal Limits (Note 2)
 Multiple Layer PCB
 Continuous Power Dissipation ($T_A = +70^\circ C$)

8-Pin μ MAX (derate 4.8mW/ $^\circ C$ above $+70^\circ C$) 387.8mW
 6-Pin TDFN-EP (derate 23.8mW/ $^\circ C$ above $+70^\circ C$)... 1904.8mW
 8-Pin SO (derate 7.6mW/ $^\circ C$ above $+70^\circ C$)..... 606.1W
 8-Pin TDFN-EP (derate 24.4mW/ $^\circ C$ above $+70^\circ C$)... 1951.2mW
 Operating Temperature Range $-40^\circ C$ to $+125^\circ C$
 Junction Temperature $+150^\circ C$
 Lead Temperature (soldering, 10s) $+300^\circ C$
 Soldering Temperature (reflow) $+260^\circ C$

Note 1: Operation is limited by thermal limits.

Stresses beyond those listed under "Absolute Maximum Ratings" may cause permanent damage to the device. These are stress ratings only, and functional operation of the device at these or any other conditions beyond those indicated in the operational sections of the specifications is not implied. Exposure to absolute maximum rating conditions for extended periods may affect device reliability.

Package Thermal Characteristics (Note 2)

| | | | |
|-------------|---|-----------|---|
| 8 μ MAX | Junction-to-Ambient Thermal Resistance (θ_{JA})206.3 $^\circ C/W$ Junction-to-Ambient Case Resistance (θ_{JC}).....42 $^\circ C/W$ | 8 SO | Junction-to-Ambient Thermal Resistance (θ_{JA})132 $^\circ C/W$ Junction-to-Ambient Case Resistance (θ_{JC}).....38 $^\circ C/W$ |
| 6 TDFN-EP | Junction-to-Ambient Thermal Resistance (θ_{JA})42 $^\circ C/W$ Junction-to-Ambient Case Resistance (θ_{JC}).....9 $^\circ C/W$ | 8 TDFN-EP | Junction-to-Ambient Thermal Resistance (θ_{JA})41 $^\circ C/W$ Junction-to-Ambient Case Resistance (θ_{JC}).....8 $^\circ C/W$ |

Note 2: Package thermal resistances were obtained using the method described in JEDEC specification JESD51-7, using a four-layer board. For detailed information on package thermal considerations, refer to www.maximintegrated.com/thermal-tutorial.

Electrical Characteristics

($V_{CC} = 15V$, $V_{EE} = -15V$, $V_{CM} = 0V$, $R_L = 10k\Omega$ to GND, $V_{GND} = 0V$, $T_A = -40^\circ C$ to $+125^\circ C$. Typical values are at $T_A = +25^\circ C$, unless otherwise noted.) (Note 3)

| PARAMETER | SYMBOL | CONDITIONS | MIN | TYP | MAX | UNITS |
|--|-----------------------|---|----------|-----|----------------|------------------|
| DC CHARACTERISTICS | | | | | | |
| Operating Supply Voltage Range | V_{SUPPLY} | Guaranteed by PSRR test | ± 3 | | ± 19 | V |
| Quiescent Supply Current per Amplifier | I_{CC} | | | 550 | 950 | μA |
| Power-Supply Rejection Ratio | PSRR | $V_S = \pm 3V$ to $\pm 19V$ | 105 | 130 | | dB |
| Input Offset Voltage | V_{OS} | $T_A = +25^\circ C$ | | 20 | 100 | μV |
| | | $T_A = -40^\circ C$ to $+125^\circ C$ | | | 240 | |
| Input Offset Voltage Drift | TCV_{OS} | | | 0.4 | | $\mu V/^\circ C$ |
| Input Bias Current | I_{BIAS} | $V_{EE} + 0.3V \leq V_{CM} \leq V_{CC} - 1.8V$ | | 4 | 20 | nA |
| | | $V_{EE} \leq V_{CM} \leq V_{CC} - 1.8V$ | | | 90 | |
| Input Offset Current | I_{OS} | $V_{EE} \leq V_{CM} \leq V_{CC} - 1.8V$ | | 1 | 10 | nA |
| Input Voltage Range | V_{IN+} , V_{IN-} | Guaranteed by CMRR test, $T_A = -40^\circ C$ to $+125^\circ C$ | V_{EE} | | $V_{CC} - 1.8$ | V |
| Common-Mode Rejection Ratio | CMRR | $V_{EE} + 0.3V \leq V_{CM} \leq V_{CC} - 1.8V$ | 105 | 125 | | dB |
| | | $V_{EE} \leq V_{CM} \leq V_{CC} - 1.8V$ | 105 | | | |

Electrical Characteristics (continued)

($V_{CC} = 15V$, $V_{EE} = -15V$, $V_{CM} = 0V$, $R_L = 10k\Omega$ to GND, $V_{GND} = 0V$, $T_A = -40^\circ C$ to $+125^\circ C$. Typical values are at $T_A = +25^\circ C$, unless otherwise noted.) (Note 3)

| PARAMETER | SYMBOL | CONDITIONS | MIN | TYP | MAX | UNITS | |
|-----------------------------|-------------|--|--------------------------------------|----------------|----------------|-------------------|--|
| Open-Loop Gain | A_{VOL} | $-13.5V \leq V_O \leq +13.5V$, $R_L = 10k\Omega$, $T_A = +25^\circ C$ | 115 | 130 | | dB | |
| | | $-13.5V \leq V_O \leq +13.5V$, $R_L = 10k\Omega$, $T_A = -40^\circ C$ to $+125^\circ C$ | 100 | | | | |
| | | $-12V \leq V_O \leq +12V$, $R_L = 600\Omega$, $T_A = +25^\circ C$ | 100 | 110 | | | |
| | | $-12V \leq V_O \leq +12V$, $R_L = 600\Omega$, $T_A = -40^\circ C$ to $+85^\circ C$ | 90 | | | | |
| Output Voltage Swing | V_{OH} | $R_L = 10k\Omega$ | $V_{CC} - 0.2$ | | | V | |
| | | $R_L = 600\Omega$ | $T_A = +25^\circ C$ | $V_{CC} - 1.8$ | | | |
| | | | $T_A = -40^\circ C$ to $+85^\circ C$ | $V_{CC} - 2$ | | | |
| | V_{OL} | $R_L = 10k\Omega$ | | | $V_{EE} + 0.1$ | | |
| | | $R_L = 600\Omega$ | $T_A = +25^\circ C$ | | $V_{EE} + 1$ | | |
| | | | $T_A = -40^\circ C$ to $+85^\circ C$ | | $V_{EE} + 1.1$ | | |
| Short-Circuit Current | I_{SC} | $T_A = +25^\circ C$ | | 60 | | mA | |
| | | $T_A = -40^\circ C$ to $+125^\circ C$ | | 100 | | | |
| AC CHARACTERISTICS | | | | | | | |
| Gain Bandwidth Product | GBWP | | | 2.4 | | MHz | |
| Slew Rate | SR | $-5V \leq V_{OUT} \leq +5V$ | | 0.35 | | V/ μs | |
| Input Voltage Noise Density | e_n | $f = 1kHz$ | | 17.6 | | nV/ \sqrt{Hz} | |
| Input Voltage Noise | TOTAL NOISE | $0.1Hz \leq f \leq 10Hz$ | | 500 | | nV _{P-P} | |
| Input Current Noise Density | I_n | $f = 1kHz$ | | 0.18 | | pA/ \sqrt{Hz} | |
| Capacitive Loading | C_{LOAD} | No sustained oscillation | | 1000 | | pF | |

Note 3: All devices are 100% production tested at $T_A = +25^\circ C$. Temperature limits are guaranteed by design.

Typical Operating Characteristics

($V_{CC} = 15V$, $V_{EE} = -15V$, $V_{CM} = 0V$, $R_L = 10k\Omega$ to GND, $V_{GND} = 0V$, $T_A = +25^\circ C$, unless otherwise noted.)

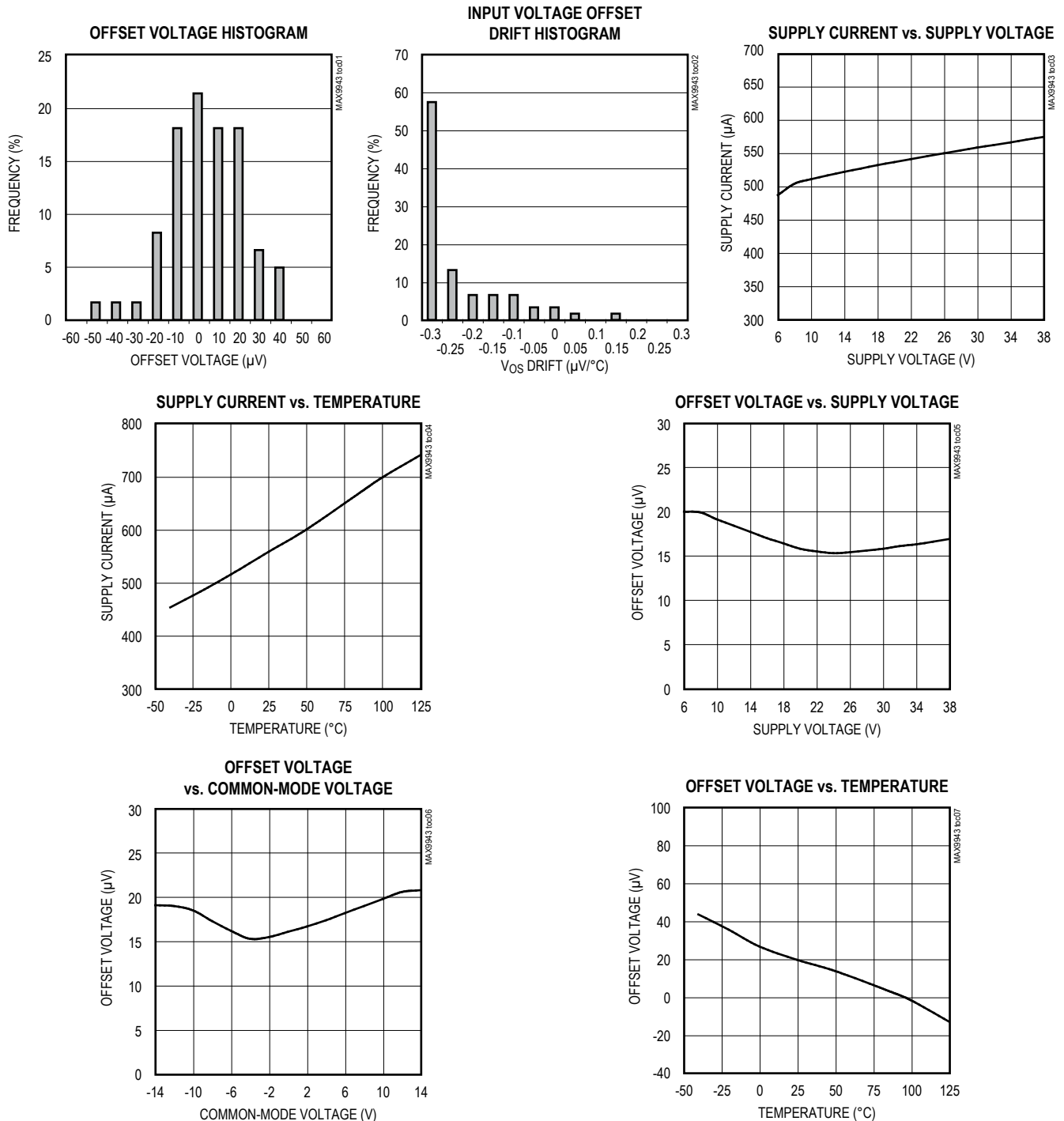

Typical Operating Characteristics (continued)

($V_{CC} = 15V$, $V_{EE} = -15V$, $V_{CM} = 0V$, $R_L = 10k\Omega$ to GND, $V_{GND} = 0V$, $T_A = +25^\circ C$, unless otherwise noted.)

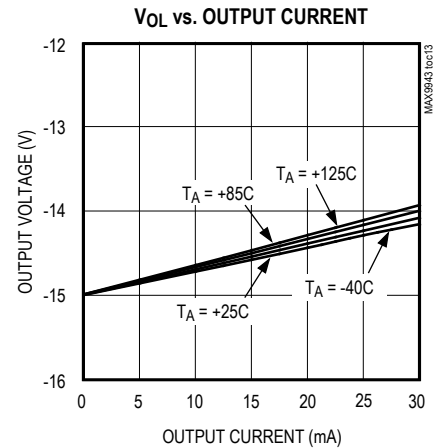
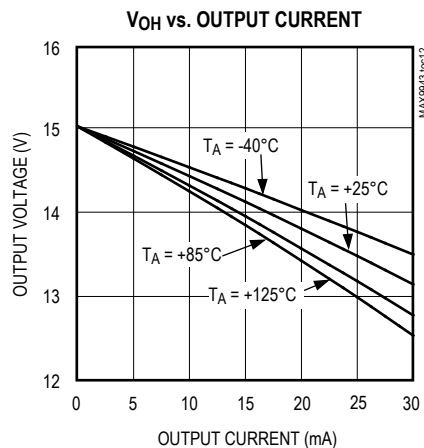
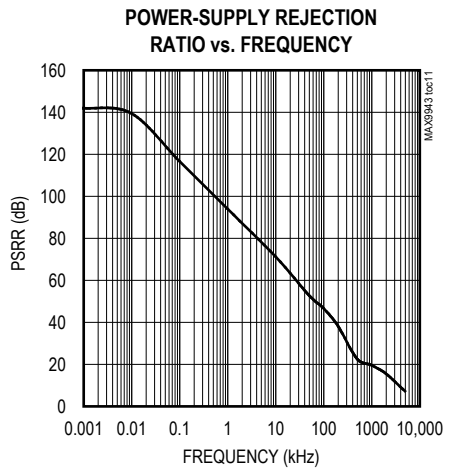
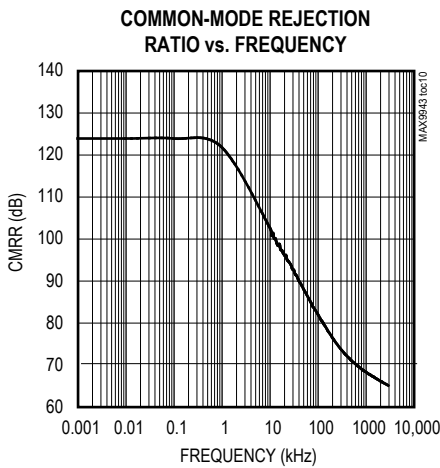
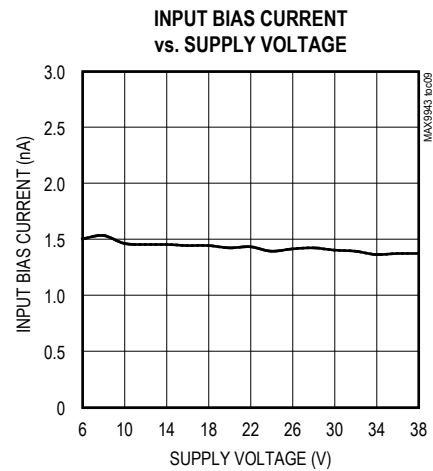
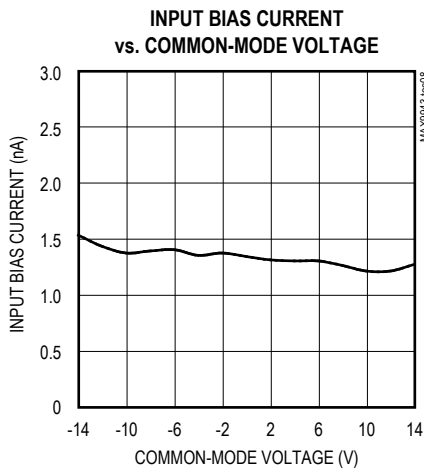

Typical Operating Characteristics (continued)

($V_{CC} = 15V$, $V_{EE} = -15V$, $V_{CM} = 0V$, $R_L = 10k\Omega$ to GND, $V_{GND} = 0V$, $T_A = +25^\circ C$, unless otherwise noted.)

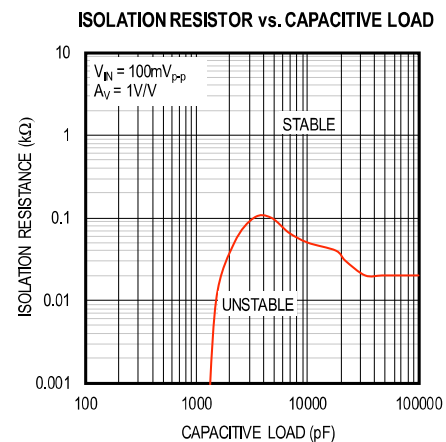
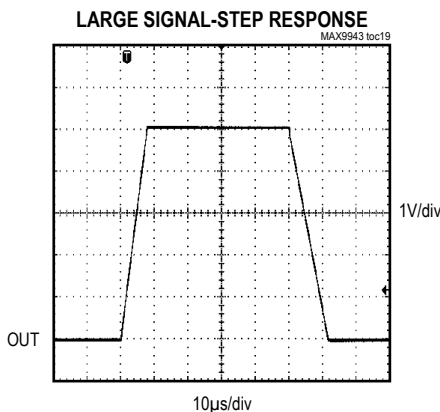
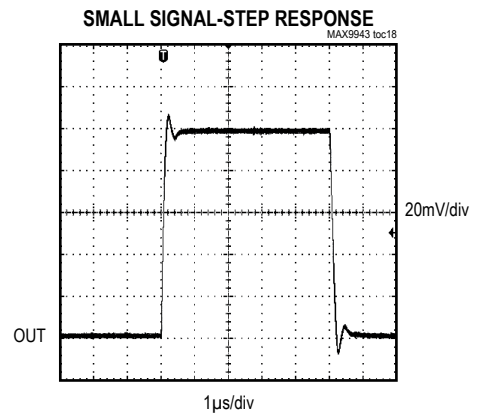
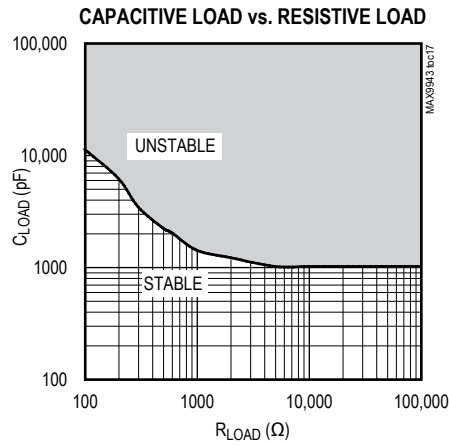
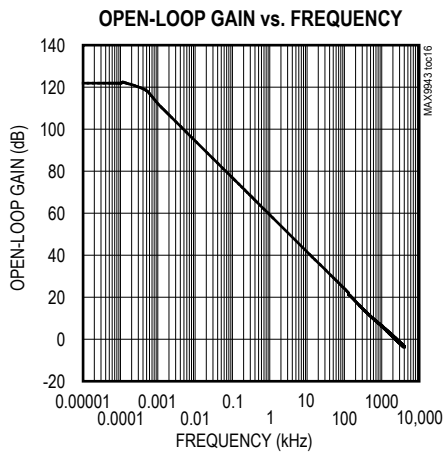
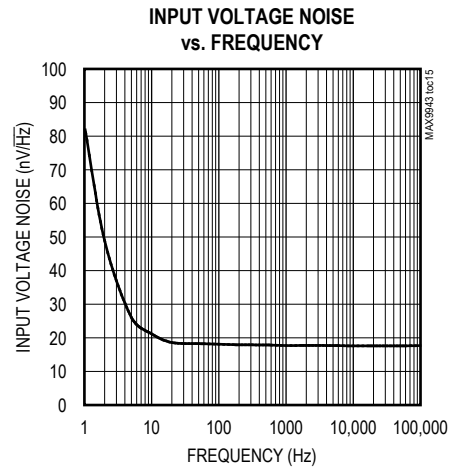
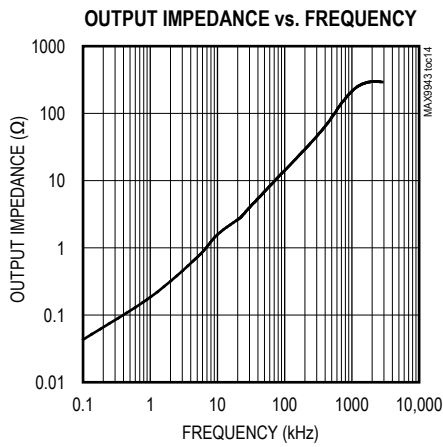

Pin Configurations

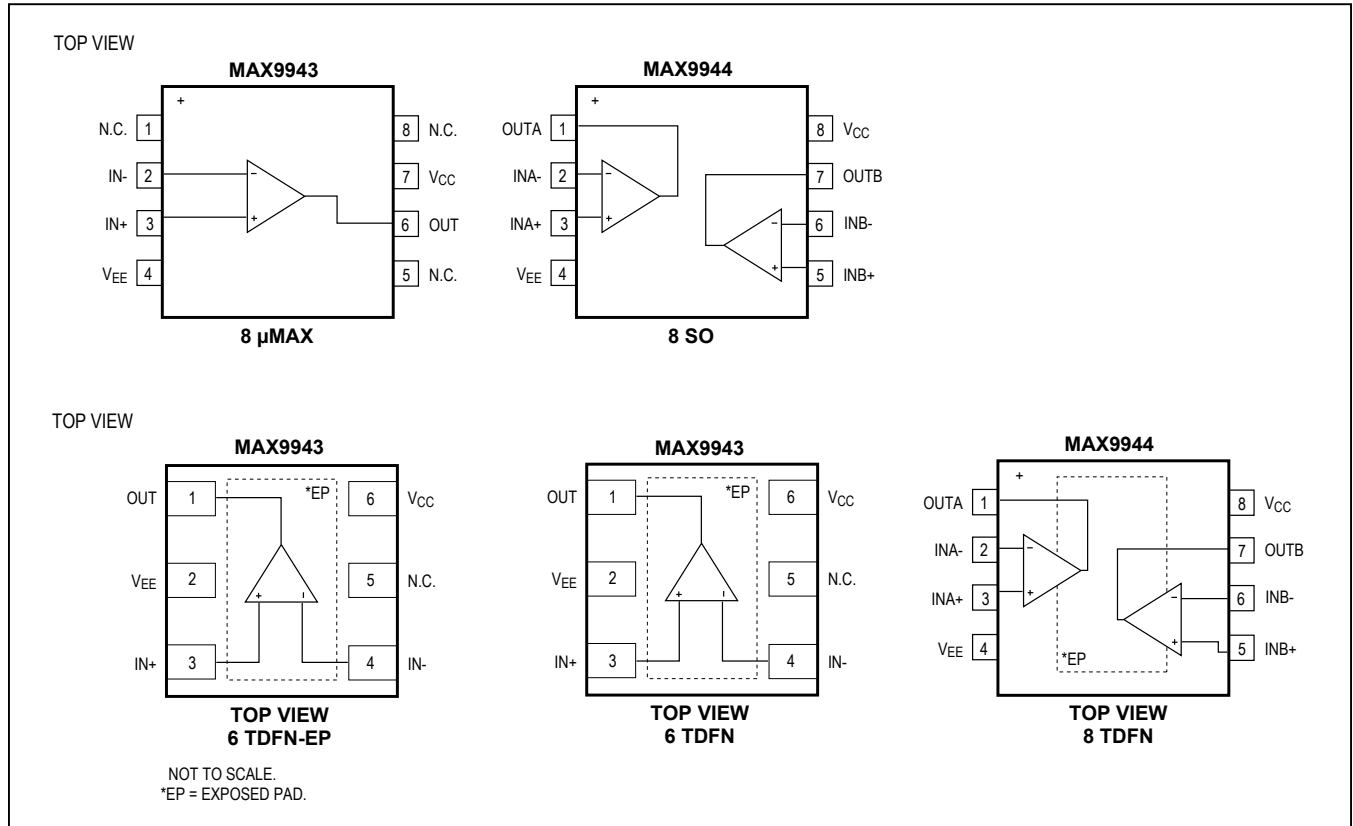

Pin Descriptions

| MAX9943 6 TDFN-EP | MAX9943 8 μMAX | MAX9944 8 SO/TDFN-EP | NAME | FUNCTION |
|----------------------|-------------------|-------------------------|-----------------|--|
| 1 | 6 | — | OUT | Output |
| — | — | 1 | OUTA | Output A |
| — | — | 7 | OUTB | Output B |
| 2 | 4 | 4 | V _{EE} | Negative Power Supply. Bypass with a 0.1μF capacitor to ground. |
| 3 | 3 | — | IN+ | Positive Input |
| — | — | 3 | INA+ | Positive Input A |
| — | — | 5 | INB+ | Positive Input B |
| 4 | 2 | — | IN- | Negative Input |
| — | — | 2 | INA- | Negative Input A |
| — | — | 6 | INB- | Negative Input B |
| 5 | 1, 5, 8 | — | N.C. | No Connection |
| 6 | 7 | 8 | V _{CC} | Positive Power Supply. Bypass with a 0.1μF capacitor to ground. |
| — | — | — | EP | Exposed Pad (TDFN Only). Connect to a large V _{EE} plane to maximize thermal performance. Not intended as an electrical connection point. |

Detailed Description

The MAX9943/MAX9944 are single/dual operational amplifiers designed for industrial applications. They operate from 6V to 38V supply range while maintaining excellent performance. These devices utilize a three-stage architecture optimized for low offset voltage and low input noise with only 550 μ A supply current. The devices are unity gain stable with a 1nF capacitive load. These well-matched devices guarantee the high open-loop gain, CMRR, PSRR, and low voltage offset.

The MAX9943/MAX9944 provide a wide input/output voltage range. The input terminals of the MAX9943/MAX9944 are protected from excessive differential voltage with back-to-back diodes. The input signal current is also limited by an internal series resistor. With a 40V differential voltage, the input current is limited to 20mA. The output can swing to the negative rail while delivering 20mA of current, which is ideal for loop-powered system applications. The specifications and operation of the MAX9943/MAX9944 family is guaranteed over the -40°C to +125°C temperature range.

Application Information

Bias Current vs. Input Common Mode

The MAX9943/MAX9944 use an internal bias current cancellation circuit to achieve very low bias current over a wide input common-mode range. For such a circuit to function properly, the input common mode must be at least 300mV away from the negative supply V_{EE} . The input common mode can reach the negative supply V_{EE} . However, in the region between V_{EE} and $V_{EE} + 0.3V$, there is an increase in bias current for both inputs.

Capacitive Load Stability

Driving large capacitive loads can cause instability in many op amps. The MAX9943/MAX9944 are stable with capacitive loads up to 1nF. The Capacitive Load vs. Resistive Load graph in the [Typical Operating Characteristics](#) gives the stable operation region for capacitive versus resistive loads. Stability with higher capacitive loads can be improved by adding an isolation resistor in series with the op-amp output, as shown in [Figure 1](#). This resistor improves the circuit's phase margin by isolating the load capacitor from the amplifier's output.

Power Supplies and Layout

The MAX9943/MAX9944 can operate with dual supplies from $\pm 3V$ to $\pm 19V$ or with a single supply from +6V to +38V with respect to ground. When used with dual supplies, bypass both V_{CC} and V_{EE} with their own 0.1 μ F capacitor

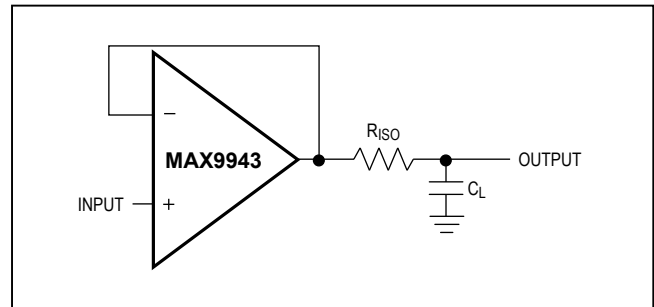

Figure 1. Capacitive Load Driving Circuit

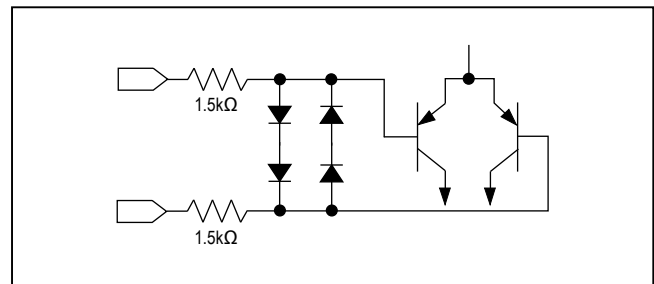

Figure 2. Input Protection Circuit

to ground. When used with a single supply, bypass V_{CC} with a 0.1 μ F capacitor to ground. Careful layout technique helps optimize performance by decreasing the amount of stray capacitance at the op amp's inputs and outputs. To decrease stray capacitance, minimize trace lengths by placing external components close to the op amp's pins.

Output Current Capability

The MAX9943/MAX9944 are capable of driving heavy loads such as the ones that can be found in loop-powered systems for remote sensors. The information is transmitted through $\pm 20mA$ or 4mA–20mA current output across long lines that are terminated with low resistance loads (e.g., 600 Ω). The *Typical Application Circuit* shows the MAX9944 used as a voltage-to-current converter with a current-sense amplifier in the feedback loop. Because of the high output current capability of the MAX9944, the device can be used to directly drive the current-loop.

The specifications and operation of the MAX9943/MAX9944 family is guaranteed over the -40°C to +125°C temperature range. However, when used in applications with $\pm 15V$ supply voltage (see [Figure 3](#)), the capability of driving more than $\pm 20mA$ of current is limited to the -40°C to +85°C temperature range. Use a lower supply voltage if this current must be delivered at a higher temperature range.

Input Common Mode and Output Swing

The MAX9943/MAX9944 input common-mode range can swing to the negative rail V_{EE} . The output voltage can swing to both the positive V_{CC} and the negative V_{EE} rails if the output stage is not heavily loaded. These two features are very important for applications where the MAX9943/MAX9944 are used with a single-supply (V_{EE} connected to ground). One of the applications that can benefit from these features is when the single-supply op amp is driving an ADC.

Input Differential Voltage Protection

During normal op-amp operation, the inverting and noninverting inputs of the MAX9943/MAX9944 are at essentially the same voltage. However, either due to fast input voltage transients or due to other fault conditions, these pins can be forced to be at two different voltages.

Internal back-to-back diodes and series resistors protect the inputs from an excessive differential voltage (see [Figure 2](#)). Therefore, IN+ and IN- can be any voltage within the range shown in the absolute maximum rating. Note the protection time is still dependent on the package thermal limits.

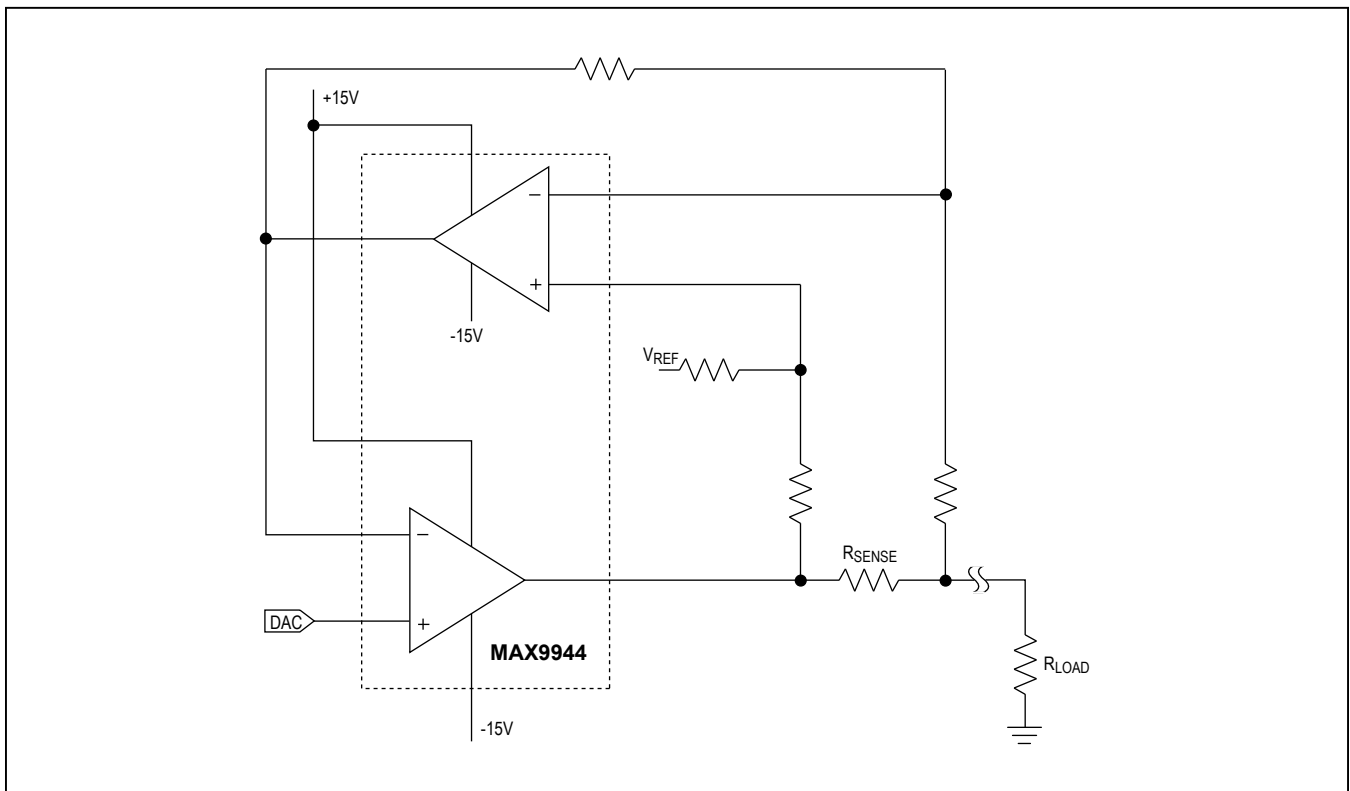

Figure 3. Typical $\pm 20\text{mA}$ Current-Source in Loop-Powered Systems

Package Information

For the latest package outline information and land patterns (footprints), go to www.maximintegrated.com/packages. Note that a "+", "#", or "-" in the package code indicates RoHS status only. Package drawings may show a different suffix character, but the drawing pertains to the package regardless of RoHS status.

| PACKAGE TYPE | PACKAGE CODE | OUTLINE NO. | LAND PATTERN NO. |
|--------------|--------------|-------------------------|-------------------------|
| 8 μ MAX | U8+1 | 21-0036 | 90-0092 |
| 6 TDFN-EP | T633+2 | 21-0137 | 90-0058 |
| 8 SO | S8+4 | 21-0041 | 90-0096 |
| 8 TDFN-EP | T833+2 | 21-0137 | 90-0059 |

Chip Information

PROCESS: BiCMOS

Ordering Information

| PART | TEMP RANGE | PIN-PACKAGE | TOP MARK |
|---------------------|-----------------|-------------|----------|
| MAX9943 AUA+ | -40°C to +125°C | 8 μ MAX | AACA |
| MAX9943ATT+ | -40°C to +125°C | 6 TDFN-EP* | AUF |
| MAX9944 ASA+ | -40°C to +125°C | 8 SO | — |
| MAX9944ATA+ | -40°C to +125°C | 8 TDFN-EP* | BLN |

+Denotes a lead(Pb)-free/RoHS-compliant package.

*EP = Exposed pad.

Revision History

| REVISION NUMBER | REVISION DATE | DESCRIPTION | PAGES CHANGED |
|-----------------|---------------|--|---------------|
| 0 | 3/09 | Initial release | — |
| 1 | 4/09 | Removed future product reference for the MAX9944, updated EC table | 1, 2 |
| 2 | 6/09 | Corrected TOC 13 and added rail-to-rail output feature | 1, 3, 5, 8 |
| 3 | 4/11 | Updated <i>Pin Description</i> section | 7 |
| 4 | 10/17 | Added TOC20 to <i>Typical Operating Characteristics</i> section | 6 |

For pricing, delivery, and ordering information, please contact Maxim Direct at 1-888-629-4642, or visit Maxim Integrated's website at www.maximintegrated.com.

Maxim Integrated cannot assume responsibility for use of any circuitry other than circuitry entirely embodied in a Maxim Integrated product. No circuit patent licenses are implied. Maxim Integrated reserves the right to change the circuitry and specifications without notice at any time. The parametric values (min and max limits) shown in the Electrical Characteristics table are guaranteed. Other parametric values quoted in this data sheet are provided for guidance.

Looking for pricing, stock, or lifecycle information?

Click below to explore more details on WIN SOURCE:

- ⊖ [View MAX9944ATA+T on WIN SOURCE](#)
- ⊖ [Maxim Integrated Information](#)

Optimize Your Supply Chain with WIN SOURCE Solutions

- ✓ Global Sourcing Solution
- ✓ Obsolete Management
- ✓ Cost Control Management
- ✓ Shortage Management
- ✓ Alternative Solution
- ✓ Excess Inventory Management