



**THE DATASHEET OF  
HLW19S-2C7LF**



## HLW Series

### 1.00MM NON-ZIF RIGHT-ANGLE AND STRAIGHT FFC-FPC CONNECTOR

Non-ZIF FFC-FPC Connector series with top and bottom contact type. These through hole connectors features a height of 3.9mm for right-angle and 5.90mm for straight type, with 4 to 32 contacts. HLW series connectors have a proven track record in automotive, data, industrial, telecommunications, consumer, and medical application equipment.

- Easy to operate and strong FFC/FPC retention makes it vibration-proof
- Ensures high solderability and high durability
- Operating temperature range of -55°C to +85°C



#### FEATURES

- Non-ZIF (Zero Insertion Force) mechanism
- Design against solder and flux wicking
- High-temperature, dimensional stable thermoplastic housing
- 4 to 32 positions available
- Lead and halogen-free

#### BENEFITS

- Achieves simple operation and stable contact with FFC/FPC
- Ensures high solderability
- Covers general operating temperature range of -55°C to +85°C
- Supports many applications as a general-purpose product
- Meet environmental, healthy and safety requirement

## TECHNICAL INFORMATION

### MATERIAL

- Housing: PBT, black color (UL94V-0): LF  
LCP, natural color (UL94V-0): HLF
- Contact: Phosphor bronze

### MECHANICAL PERFORMANCE

- FFC/FPC Insertion Force: 1.96N/contact max.
- FFC/FPC Retention Force: 0.49N/contact min.
- Durability: 10 mating cycles

### ELECTRICAL PERFORMANCE

- Voltage Rating: 100V A.C./D.C.
- Current Rating: 1.0A A.C./D.C.
- Contact Resistance: 30mΩ max.(initial value)
- Insulation Resistance: 500MΩ min.
- Dielectric Withstanding Voltage: No short or breakdown after 500V A.C., 1mA, 1min.

### ENVIRONMENTAL

- Operating Temperature Range: -55°C to +85°C

### APPROVALS & CERTIFICATION

- RoHS compliant

### SPECIFICATIONS

- Orientation: Right-angle and straight
- Cable Termination: Non-ZIF
- Cable type: FFC/ FPC
- Board Termination: Through hole (DIP)
- Contact Location: Top
- Height: 3.9mm (right-angle) and 5.9mm (straight)
- Lead free tin plating

### TARGET MARKETS/APPLICATIONS



Dashboard  
Lighting



Gaming  
LCD & OLED Displays



Base Station  
Switches  
Controllers  
Storage



Controllers  
HMI  
Vending Machines  
PLC  
Drives



Ultrasonic  
Patient Monitor  
MRI  
CT  
Infusion Pump  
Hospital Bed

## PART NUMBER SELECTOR

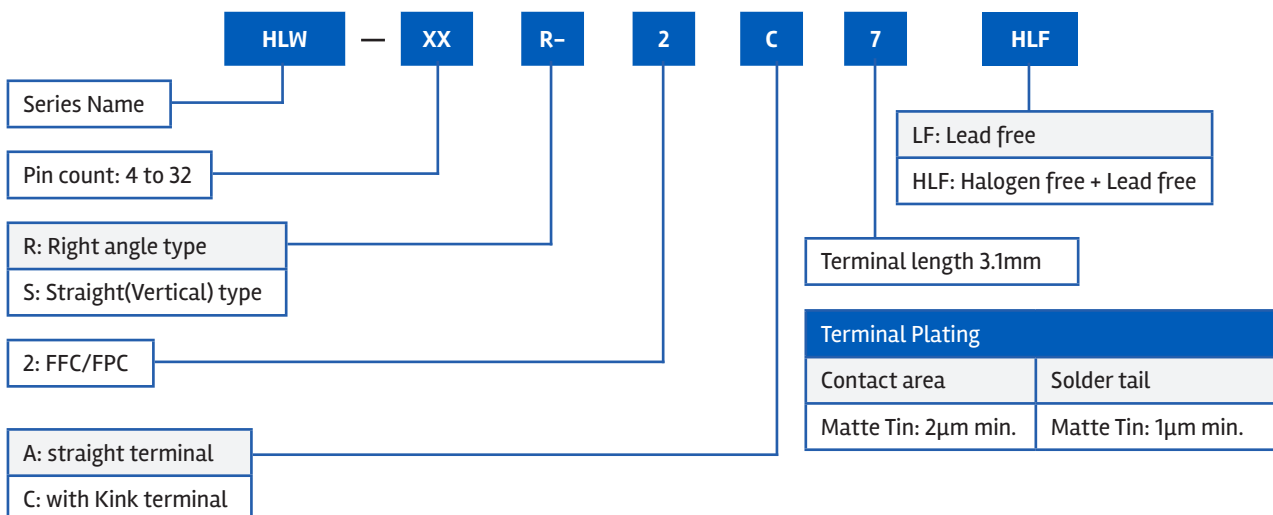

BASICSHLW0422EA4

## Looking for pricing, stock, or lifecycle information?

Click below to explore more details on WIN SOURCE:

 [View HLW19S-2C7LF on WIN SOURCE](#)

 [Amphenol Information](#)

## Optimize Your Supply Chain with WIN SOURCE Solutions

-  Global Sourcing Solution
-  Obsolete Management
-  Cost Control Management
-  Shortage Management
-  Alternative Solution
-  Excess Inventory Management