



**THE DATASHEET OF
CDMG16008-03**



MODEL: CDMG16008-03 | **DESCRIPTION:** SPEAKER**FEATURES**

- 16 mm round frame
- 0.3 W input power
- 8.0 Ohm
- PET cone
- neodymium magnet

**SPECIFICATIONS**

parameter	conditions/description	min	typ	max	units
input power	max. power: IEC-60268-5, filter 60 s on / 120 s off, 10 cycles at room temp		0.3	0.5	W
impedance	at 1.0 kHz, 1 V	6.8	8	9.2	Ω
resonant frequency	at 1 V	480	600	720	Hz
response				20,000	Hz
sound pressure level	at 0.3 W, 10 cm ave. at 1.0, 1.2, 1.5, 2.0 kHz	79	82	85	dB
	at 1.0 W, 1 m ave. at 1.0, 1.2, 1.5, 2.0 kHz	66	69	72	dB
distortion	at 1.0 kHz, 0.3 W			10	%
buzz, rattle, etc.	must be normal at sine wave between Fo-20 kHz			1.55	V
dimensions	$\varnothing 16 \times 2.55$				mm
magnet	Nd-Fe-B				
material	metal				
cone material	PET				
terminal	solder pads				
operating temperature		-20		55	$^{\circ}\text{C}$
weight			1.5		g
RoHS	yes				

SOLDERABILITY

parameter	conditions/description	min	typ	max	units
hand soldering	for 3±1 seconds	360	370	380	$^{\circ}\text{C}$

MECHANICAL DRAWING

units: mm
tolerance: ± 0.5 mm

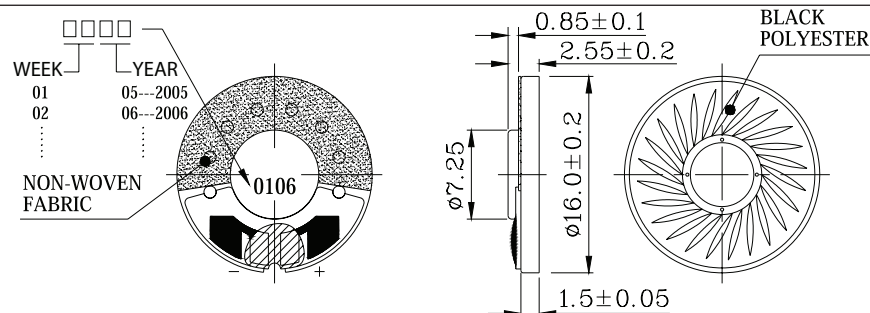

The mylar won't exceed the metal frame when input 0.3W.

RESPONSE CURVES

Frequency Response Curve

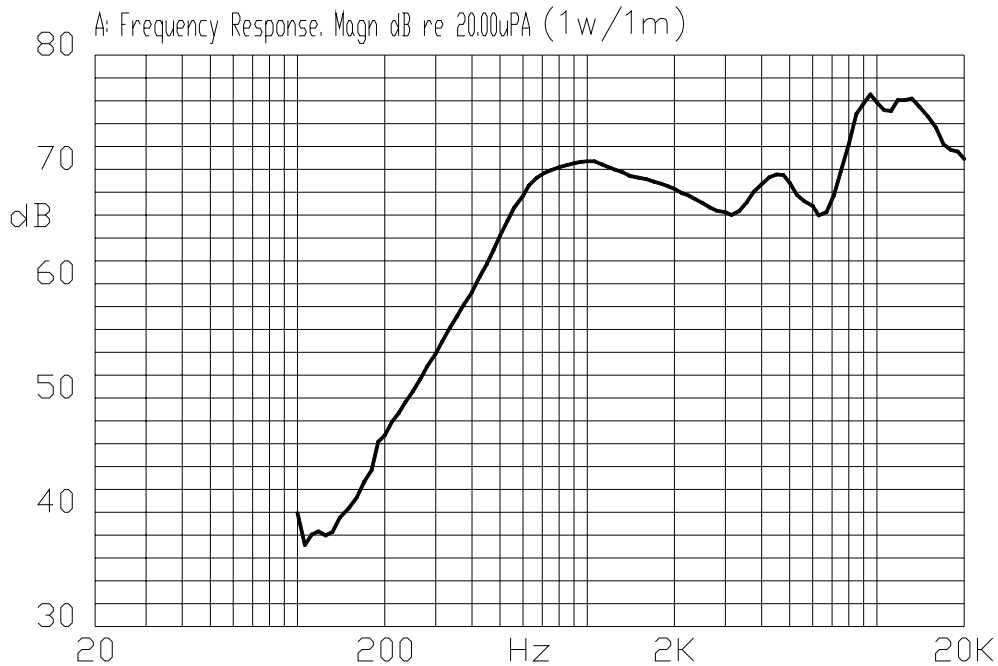
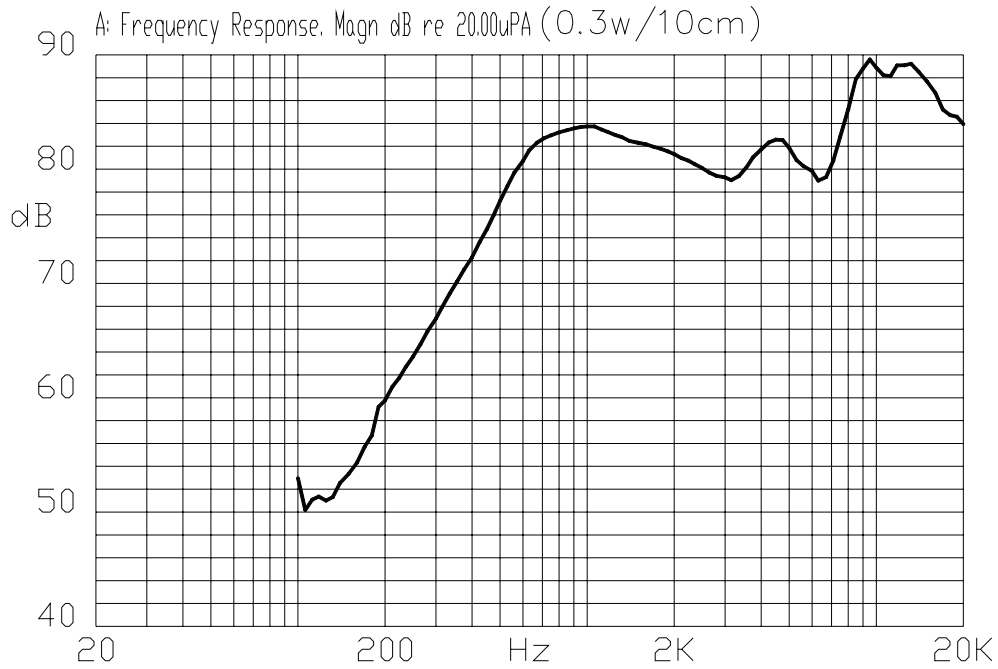

THIELE-SMALL PARAMETERS

parameter	conditions/description	typ
Mechanical Q Factor	Qms	1.6126
Electrical Q Factor	Qes	69.4704
Total Q Factor	Qts	1.576
Compliance Equivalent Volume	Vas	0.0002

Notes: 2. Results represent typical performance in Free Air conditions.

PACKAGING

units: mm

Tray Size: 350 x 235 x 20 mm
 Tray QTY: 100 pcs per tray
 Carton Size: 355 x 242 x 300 mm
 Carton QTY: 2,500 pcs

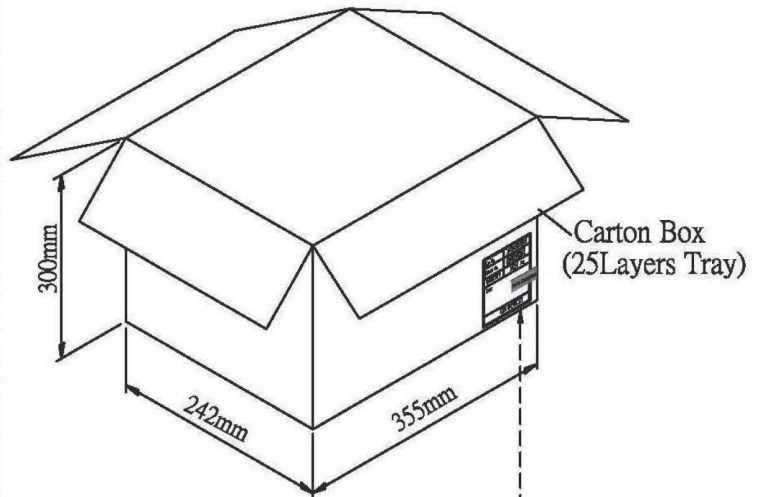
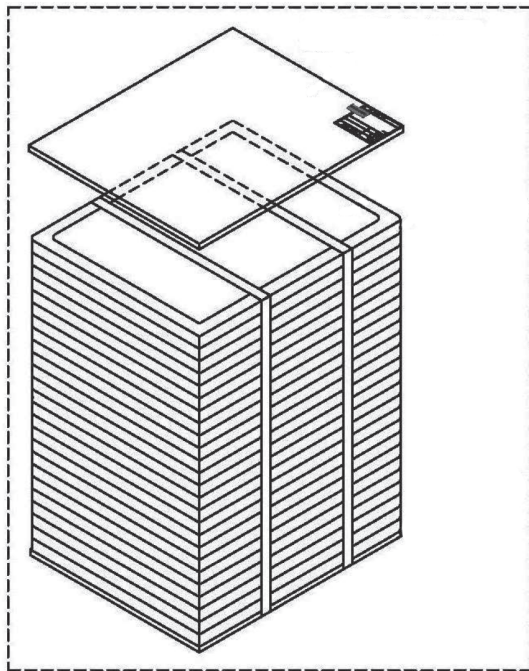
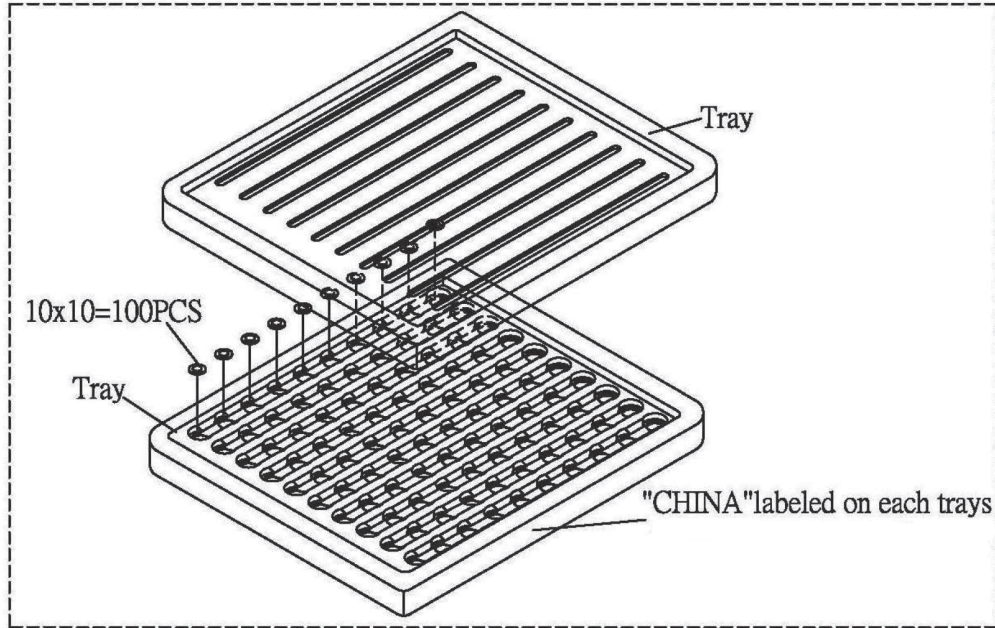

Lot No.	XXXXXXXXXX
Model No.	XXXXXXXXXX XXXXXXXXXX
Quantity.	XXXX Pcs
Date:	DD MM YY
	RoHS Compliant

REVISION HISTORY

rev.	description	date
1.0	initial release	10/18/2006
1.01	updated datasheet	02/01/2010
1.02	brand update	04/15/2021
1.03	logo, datasheet style update	08/05/2022
1.04	CUI Devices rebranded to Same Sky	09/11/2024
1.05	added Thiele-Small Parameters	02/07/2025

The revision history provided is for informational purposes only and is believed to be accurate.



Same Sky offers a one (1) year limited warranty. Complete warranty information is listed on our website.



Same Sky reserves the right to make changes to the product at any time without notice. Information provided by Same Sky is believed to be accurate and reliable. However, no responsibility is assumed by Same Sky for its use, nor for any infringements of patents or other rights of third parties which may result from its use.

Same Sky products are not authorized or warranted for use as critical components in equipment that requires an extremely high level of reliability. A critical component is any component of a life support device or system whose failure to perform can be reasonably expected to cause the failure of the life support device or system, or to affect its safety or effectiveness.

[sameskydevices.com](https://www.sameskydevices.com)

Looking for pricing, stock, or lifecycle information?

Click below to explore more details on WIN SOURCE:

-  [View CDMG16008-03 on WIN SOURCE](#)
-  [Same Sky Information](#)

Optimize Your Supply Chain with WIN SOURCE Solutions

-  Global Sourcing Solution
-  Obsolete Management
-  Cost Control Management
-  Shortage Management
-  Alternative Solution
-  Excess Inventory Management