



**THE DATASHEET OF  
SN74AUP1G02YFPR**



## SN74AUP1G02 Low-Power Single 2-Input Positive-NOR Gate

### 1 Features

- Available in the Ultra Small 0.64 mm<sup>2</sup> Package (DPW) with 0.5-mm Pitch
- Low Static-Power Consumption ( $I_{CC} = 0.9 \mu\text{A Max}$ )
- Low Dynamic-Power Consumption ( $C_{pd} = 4.3 \text{ pF Typ at } 3.3 \text{ V}$ )
- Low Input Capacitance ( $C_i = 1.5 \text{ pF Typ}$ )
- Low Noise – Overshoot and Undershoot  $<10\%$  of  $V_{CC}$
- $I_{off}$  Supports Live Insertion, Partial-Power-Down Mode, and Back-Drive Protection
- Input Hysteresis Allows Slow Input Transition and Better Switching-Noise Immunity at the Input ( $V_{hys} = 250 \text{ mV Typ at } 3.3 \text{ V}$ )
- Wide Operating  $V_{CC}$  Range of 0.8 V to 3.6 V
- Optimized for 3.3-V Operation
- 3.6-V I/O Tolerant to Support Mixed-Mode Signal Operation
- $t_{pd} = 4.6 \text{ ns Max at } 3.3 \text{ V}$
- Suitable for Point-to-Point Applications
- Latch-Up Performance Exceeds 100 mA Per JESD 78, Class II
- ESD Performance Tested Per JESD 22
  - 2000-V Human-Body Model (A114-B, Class II)
  - 1000-V Charged-Device Model (C101)

### Simplified Schematic



### 2 Applications

- ATCA Solutions
- Active Noise Cancellation (ANC)
- Barcode Scanner
- Blood Pressure Monitor
- CPAP Machine
- Cable Solutions
- DLP 3D Machine Vision, Hyperspectral Imaging, Optical Networking, and Spectroscopy
- E-Book
- Embedded PC
- Field Transmitter: Temperature or Pressure Sensor
- Fingerprint Biometrics
- HVAC: Heating, Ventilating, and Air Conditioning
- Network-Attached Storage (NAS)
- Server Motherboard and PSU
- Software Defined Radio (SDR)
- TV: High-Definition (HDTV), LCD, and Digital
- Video Communications System
- Wireless Data Access Card, Headset, Keyboard, Mouse, and LAN Card
- X-ray: Baggage Scanner, Medical, and Dental

### 3 Description

This single 2-input positive-NOR gate performs the Boolean function  $Y = A + B$  or  $Y = A \times B$  in positive logic.

### Device Information<sup>(1)</sup>

PART NUMBER	PACKAGE	BODY SIZE (NOM)
SN74AUP1G02	SOT-23 (5)	2.90 mm × 1.60 mm
	SC70 (5)	2.00 mm × 1.25 mm
	SOT (5)	1.60 mm × 1.20 mm
	SON (6)	1.45 mm × 1.00 mm
	SON (6)	1.00 mm × 1.00 mm
	X2SON (5)	0.80 mm × 0.80 mm
	DSBGA (6)	1.76 mm × 0.76 mm

(1) For all available packages, see the orderable addendum at the end of the data sheet.



## Table of Contents

<b>1 Features</b> .....	<b>1</b>	<b>8 Detailed Description</b> .....	<b>11</b>
<b>2 Applications</b> .....	<b>1</b>	8.1 Overview .....	11
<b>3 Description</b> .....	<b>1</b>	8.2 Functional Block Diagram .....	11
<b>4 Revision History</b> .....	<b>2</b>	8.3 Feature Description .....	11
<b>5 Pin Configuration and Functions</b> .....	<b>3</b>	8.4 Device Functional Modes .....	11
<b>6 Specifications</b> .....	<b>4</b>	<b>9 Application and Implementation</b> .....	<b>12</b>
6.1 Absolute Maximum Ratings .....	4	9.1 Application Information .....	12
6.2 ESD Ratings .....	4	9.2 Typical Application .....	12
6.3 Recommended Operating Conditions .....	5	<b>10 Power Supply Recommendations</b> .....	<b>14</b>
6.4 Thermal Information .....	5	<b>11 Layout</b> .....	<b>14</b>
6.5 Electrical Characteristics .....	6	11.1 Layout Guidelines .....	14
6.6 Switching Characteristics, $C_L = 5$ pF .....	6	11.2 Layout Example .....	14
6.7 Switching Characteristics, $C_L = 10$ pF .....	7	<b>12 Device and Documentation Support</b> .....	<b>15</b>
6.8 Switching Characteristics, $C_L = 15$ pF .....	7	12.1 Receiving Notification of Documentation Updates .....	15
6.9 Switching Characteristics, $C_L = 30$ pF .....	7	12.2 Community Resources .....	15
6.10 Operating Characteristics .....	7	12.3 Trademarks .....	15
6.11 Typical Characteristics .....	8	12.4 Electrostatic Discharge Caution .....	15
<b>7 Parameter Measurement Information</b> .....	<b>9</b>	12.5 Glossary .....	15
7.1 Propagation Delays, Setup and Hold Times, and Pulse Duration .....	9	<b>13 Mechanical, Packaging, and Orderable Information</b> .....	<b>15</b>
7.2 Enable and Disable Times .....	10		

## 4 Revision History

NOTE: Page numbers for previous revisions may differ from page numbers in the current version.

Changes from Revision H (June 2014) to Revision I	Page
• Added missing packages and body size to <i>Device Information</i> table .....	1
• Updated pinout images to new format .....	3
• Updated <i>Pin Functions</i> table .....	3
• Moved Storage temperature, $T_{stg}$ to <i>Absolute Maximum Ratings</i> .....	4
• Changed <i>Handling Ratings</i> table to <i>ESD Ratings</i> table .....	4
• Added <i>Receiving Notification of Documentation Updates</i> section and <i>Community Resources</i> section .....	15

Changes from Revision G (March 2010) to Revision H	Page
• Updated document to new TI data sheet format .....	1
• Deleted Ordering Information table .....	1
• Updated $I_{off}$ in Features .....	1
• Added Applications .....	1
• Added DPW Package .....	3
• Added Handling Ratings table .....	4
• Added Thermal Information table .....	5
• Added Typical Characteristics .....	8

## 5 Pin Configuration and Functions

DBV, DCK, or DRL Package  
5-Pin SOT-23, SC70, or SOT  
Top View

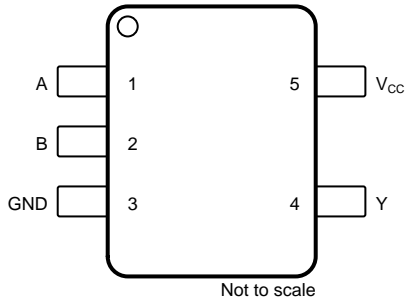

DRY or DSF Package  
6-Pin SON  
Top View

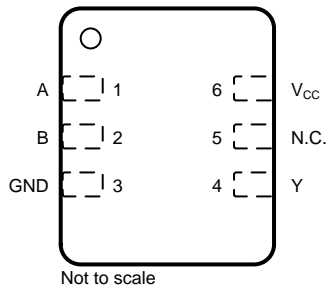

N.C. – No internal connection

YFP Package  
6-Pin DSBGA  
Bottom View

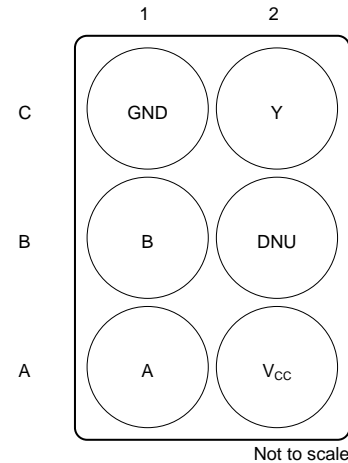

DNU – Do not use

DPW Package  
5-Pin X2SON  
Top View

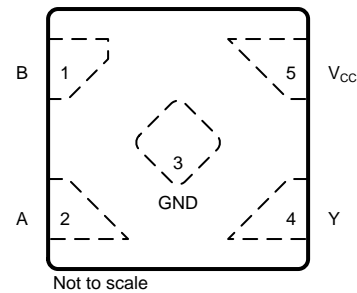

See mechanical drawings for dimensions.

### Pin Functions

NAME	PIN				I/O	DESCRIPTION
	DBV, DCK, DRL	DPW	DRY, DSF	YFP		
A	1	2	1	A1	I	Input A
B	2	1	2	B1	I	Input B
DNU	—	—	—	B2	—	Do not use
GND	3	3	3	C1	—	Ground
N.C.	—	—	5	—	—	No internal connection
Y	4	4	4	C2	O	Output Y
VCC	5	5	6	A2	—	Power Pin

## 6 Specifications

### 6.1 Absolute Maximum Ratings

over operating free-air temperature range (unless otherwise noted)<sup>(1)</sup>

		MIN	MAX	UNIT
V <sub>CC</sub>	Supply voltage	−0.5	4.6	V
V <sub>I</sub>	Input voltage <sup>(2)</sup>	−0.5	4.6	V
V <sub>O</sub>	Voltage range applied to any output in the high-impedance or power-off state <sup>(2)</sup>	−0.5	4.6	V
V <sub>O</sub>	Output voltage range in the high or low state <sup>(2)</sup>	−0.5	V <sub>CC</sub> + 0.5	V
I <sub>IK</sub>	Input clamp current	V <sub>I</sub> < 0	−50	mA
I <sub>OK</sub>	Output clamp current	V <sub>O</sub> < 0	−50	mA
I <sub>O</sub>	Continuous output current		±20	mA
	Continuous current through V <sub>CC</sub> or GND		±50	mA
T <sub>stg</sub>	Storage temperature	−65	150	°C

- (1) Stresses beyond those listed under *Absolute Maximum Ratings* may cause permanent damage to the device. These are stress ratings only, and functional operation of the device at these or any other conditions beyond those indicated under *Recommended Operating Conditions* is not implied. Exposure to absolute-maximum-rated conditions for extended periods may affect device reliability.
- (2) The input negative-voltage and output voltage ratings may be exceeded if the input and output current ratings are observed.

### 6.2 ESD Ratings

		VALUE	UNIT
V <sub>(ESD)</sub>	Electrostatic discharge	Human body model (HBM), per ANSI/ESDA/JEDEC JS-001 <sup>(1)</sup>	2000
		Charged device model (CDM), per JEDEC specification JESD22-C101 <sup>(2)</sup>	1000

- (1) JEDEC document JEP155 states that 500-V HBM allows safe manufacturing with a standard ESD control process.
- (2) JEDEC document JEP157 states that 250-V CDM allows safe manufacturing with a standard ESD control process.

### 6.3 Recommended Operating Conditions

over operating free-air temperature range (unless otherwise noted)<sup>(1)</sup>

		MIN	MAX	UNIT	
V <sub>CC</sub>	Supply voltage	0.8	3.6	V	
V <sub>IH</sub>	High-level input voltage	V <sub>CC</sub> = 0.8 V	V <sub>CC</sub>	V	
		V <sub>CC</sub> = 1.1 V to 1.95 V	0.65 × V <sub>CC</sub>		
		V <sub>CC</sub> = 2.3 V to 2.7 V	1.6		
		V <sub>CC</sub> = 3 V to 3.6 V	2		
V <sub>IL</sub>	Low-level input voltage	V <sub>CC</sub> = 0.8 V	0	V	
		V <sub>CC</sub> = 1.1 V to 1.95 V	0.35 × V <sub>CC</sub>		
		V <sub>CC</sub> = 2.3 V to 2.7 V	0.7		
		V <sub>CC</sub> = 3 V to 3.6 V	0.9		
V <sub>I</sub>	Input voltage	0	3.6	V	
V <sub>O</sub>	Output voltage	0	V <sub>CC</sub>	V	
I <sub>OH</sub>	High-level output current	V <sub>CC</sub> = 0.8 V	–20	μA	
		V <sub>CC</sub> = 1.1 V	–1.1		
		V <sub>CC</sub> = 1.4 V	–1.7		
		V <sub>CC</sub> = 1.65 V	–1.9		
		V <sub>CC</sub> = 2.3 V	–3.1		
		V <sub>CC</sub> = 3 V	–4		
I <sub>OL</sub>	Low-level output current	V <sub>CC</sub> = 0.8 V	20	μA	
		V <sub>CC</sub> = 1.1 V	1.1		
		V <sub>CC</sub> = 1.4 V	1.7		
		V <sub>CC</sub> = 1.65 V	1.9		
		V <sub>CC</sub> = 2.3 V	3.1		
		V <sub>CC</sub> = 3 V	4		
Δt/Δv	Input transition rise or fall rate	V <sub>CC</sub> = 0.8 V to 3.6 V		200	ns/V
T <sub>A</sub>	Operating free-air temperature	–40	85	°C	

(1) All unused inputs of the device must be held at V<sub>CC</sub> or GND to ensure proper device operation. See the TI application report, *Implications of Slow or Floating CMOS Inputs*, [SCBA004](#).

### 6.4 Thermal Information

THERMAL METRIC <sup>(1)</sup>	SN74AUP1G02						UNIT	
	DBV (SOT-23)	DCK (SC70)	DPW (X2SON)	DRL (SOT)	DRY (SON)	DSF (SON)		
	5 PINS	5 PINS	5 PINS	5 PINS	6 PINS	6 PINS		
R <sub>θJA</sub>	Junction-to-ambient thermal resistance	298.6	314.4	291.8	349.7	554.9	407.1	°C/W
R <sub>θJC(top)</sub>	Junction-to-case (top) thermal resistance	240.2	128.7	224.2	120.5	385.4	232	°C/W
R <sub>θJB</sub>	Junction-to-board thermal resistance	134.6	100.6	245.8	171.4	388.2	306.9	°C/W
Ψ <sub>JT</sub>	Junction-to-top characterization parameter	114.5	7.1	31.4	10.8	159	40.3	°C/W
Ψ <sub>JB</sub>	Junction-to-board characterization parameter	133.9	99.8	245.6	169.4	384.1	306	°C/W
R <sub>θJC(bot)</sub>	Junction-to-case (bottom) thermal resistance	n/a	n/a	195.4	n/a	n/a	n/a	°C/W

(1) For more information about traditional and new thermal metrics, see the *Semiconductor and IC Package Thermal Metrics* application report.

## 6.5 Electrical Characteristics

over recommended operating free-air temperature range (unless otherwise noted)

PARAMETER	TEST CONDITIONS	V <sub>CC</sub>	T <sub>A</sub> = 25°C			T <sub>A</sub> = -40°C to +85°C		UNIT
			MIN	TYP	MAX	MIN	MAX	
V <sub>OH</sub>	I <sub>OH</sub> = -20 μA	0.8 V to 3.6 V	V <sub>CC</sub> - 0.1			V <sub>CC</sub> - 0.1		V
	I <sub>OH</sub> = -1.1 mA	1.1 V	0.75 × V <sub>CC</sub>			0.7 × V <sub>CC</sub>		
	I <sub>OH</sub> = -1.7 mA	1.4 V	1.11			1.03		
	I <sub>OH</sub> = -1.9 mA	1.65 V	1.32			1.3		
	I <sub>OH</sub> = -2.3 mA	2.3 V	2.05			1.97		
	I <sub>OH</sub> = -3.1 mA		1.9			1.85		
	I <sub>OH</sub> = -2.7 mA	3 V	2.72			2.67		
	I <sub>OH</sub> = -4 mA		2.6			2.55		
V <sub>OL</sub>	I <sub>OL</sub> = 20 μA	0.8 V to 3.6 V	0.1			0.1		V
	I <sub>OL</sub> = 1.1 mA	1.1 V	0.3 × V <sub>CC</sub>			0.3 × V <sub>CC</sub>		
	I <sub>OL</sub> = 1.7 mA	1.4 V	0.31			0.37		
	I <sub>OL</sub> = 1.9 mA	1.65 V	0.31			0.35		
	I <sub>OL</sub> = 2.3 mA	2.3 V	0.31			0.33		
	I <sub>OL</sub> = 3.1 mA		0.44			0.45		
	I <sub>OL</sub> = 2.7 mA	3 V	0.31			0.33		
	I <sub>OL</sub> = 4 mA		0.44			0.45		
I <sub>I</sub>	A or B inputs	V <sub>I</sub> = GND to 3.6 V	0 V to 3.6 V			0.1	0.5	μA
I <sub>off</sub>		V <sub>I</sub> or V <sub>O</sub> = 0 V to 3.6 V	0 V			0.2	0.6	μA
ΔI <sub>off</sub>		V <sub>I</sub> or V <sub>O</sub> = 0 V to 3.6 V	0 V to 0.2 V			0.2	0.6	μA
I <sub>CC</sub>		V <sub>I</sub> = GND or (V <sub>CC</sub> to 3.6 V), I <sub>O</sub> = 0	0.8 V to 3.6 V			0.5	0.9	μA
ΔI <sub>CC</sub>		V <sub>I</sub> = V <sub>CC</sub> - 0.6 V <sup>(1)</sup> , I <sub>O</sub> = 0	3.3 V			40	50	μA
C <sub>i</sub>	V <sub>I</sub> = V <sub>CC</sub> or GND	0 V	1.5					pF
		3.6 V	1.5					
C <sub>o</sub>	V <sub>O</sub> = GND	0 V	3					pF

 (1) One input at V<sub>CC</sub> - 0.6 V, other input at V<sub>CC</sub> or GND.

## 6.6 Switching Characteristics, C<sub>L</sub> = 5 pF

 over recommended operating free-air temperature range (unless otherwise noted) (see [Figure 3](#) and [Figure 4](#))

PARAMETER	FROM (INPUT)	TO (OUTPUT)	V <sub>CC</sub>	T <sub>A</sub> = 25°C			T <sub>A</sub> = -40°C to +85°C		UNIT
				MIN	TYP	MAX	MIN	MAX	
t <sub>pd</sub>	A or B	Y	0.8 V	19.3					ns
			1.2 V ± 0.1 V	2.6	7.3	13	2.1	16.3	
			1.5 V ± 0.1 V	1.4	5.2	8.9	0.9	10.8	
			1.8 V ± 0.15 V	1	4.2	6.8	0.5	8.7	
			2.5 V ± 0.2 V	1	3	4.6	0.5	5.9	
			3.3 V ± 0.3 V	1	2.4	3.7	0.5	4.6	

### 6.7 Switching Characteristics, $C_L = 10 \text{ pF}$

 over recommended operating free-air temperature range (unless otherwise noted) (see [Figure 3](#) and [Figure 4](#))

PARAMETER	FROM (INPUT)	TO (OUTPUT)	$V_{CC}$	$T_A = 25^\circ\text{C}$			$T_A = -40^\circ\text{C to } +85^\circ\text{C}$		UNIT
				MIN	TYP	MAX	MIN	MAX	
$t_{pd}$	A or B	Y	0.8 V	22.3					ns
			$1.2 \text{ V} \pm 0.1 \text{ V}$	1.5	8.5	14.9	1	17.9	
			$1.5 \text{ V} \pm 0.1 \text{ V}$	1	6.2	10.2	0.5	11.8	
			$1.8 \text{ V} \pm 0.15 \text{ V}$	1	5	7.9	0.5	9.5	
			$2.5 \text{ V} \pm 0.2 \text{ V}$	1	3.6	5.4	0.5	6.5	
			$3.3 \text{ V} \pm 0.3 \text{ V}$	1	2.9	4.4	0.5	5	

### 6.8 Switching Characteristics, $C_L = 15 \text{ pF}$

 over recommended operating free-air temperature range (unless otherwise noted) (see [Figure 3](#) and [Figure 4](#))

PARAMETER	FROM (INPUT)	TO (OUTPUT)	$V_{CC}$	$T_A = 25^\circ\text{C}$			$T_A = -40^\circ\text{C to } +85^\circ\text{C}$		UNIT
				MIN	TYP	MAX	MIN	MAX	
$t_{pd}$	A or B	Y	0.8 V	25					ns
			$1.2 \text{ V} \pm 0.1 \text{ V}$	3.6	9.9	16.5	3.1	20.6	
			$1.5 \text{ V} \pm 0.1 \text{ V}$	2.3	7.2	11.3	1.8	13.7	
			$1.8 \text{ V} \pm 0.15 \text{ V}$	1.6	5.8	8.9	1.1	11.1	
			$2.5 \text{ V} \pm 0.2 \text{ V}$	1	4.3	6.1	0.5	7.7	
			$3.3 \text{ V} \pm 0.3 \text{ V}$	1	3.4	5	0.5	6.2	

### 6.9 Switching Characteristics, $C_L = 30 \text{ pF}$

 over recommended operating free-air temperature range (unless otherwise noted) (see [Figure 3](#) and [Figure 4](#))

PARAMETER	FROM (INPUT)	TO (OUTPUT)	$V_{CC}$	$T_A = 25^\circ\text{C}$			$T_A = -40^\circ\text{C to } +85^\circ\text{C}$		UNIT
				MIN	TYP	MAX	MIN	MAX	
$t_{pd}$	A or B	Y	0.8 V	34.6					ns
			$1.2 \text{ V} \pm 0.1 \text{ V}$	4.9	13.1	21.1	4.4	26.2	
			$1.5 \text{ V} \pm 0.1 \text{ V}$	3.4	9.5	14.4	2.9	17.4	
			$1.8 \text{ V} \pm 0.15 \text{ V}$	2.5	7.7	11.2	2	14	
			$2.5 \text{ V} \pm 0.2 \text{ V}$	1.8	5.7	7.8	1.3	9.8	
			$3.3 \text{ V} \pm 0.3 \text{ V}$	1.5	4.7	6.4	1	7.8	

### 6.10 Operating Characteristics

 $T_A = 25^\circ\text{C}$ 

PARAMETER	TEST CONDITIONS	$V_{CC}$	TYP	UNIT
$C_{pd}$ Power dissipation capacitance	$f = 10 \text{ MHz}$	0.8 V	4.1	pF
		$1.2 \text{ V} \pm 0.1 \text{ V}$	4.1	
		$1.5 \text{ V} \pm 0.1 \text{ V}$	4.1	
		$1.8 \text{ V} \pm 0.15 \text{ V}$	4.1	
		$2.5 \text{ V} \pm 0.2 \text{ V}$	4.2	
		$3.3 \text{ V} \pm 0.3 \text{ V}$	4.3	

**SN74AUP1G02**

SCES568I – JUNE 2004 – REVISED SEPTEMBER 2016

[www.ti.com](http://www.ti.com)

**6.11 Typical Characteristics**

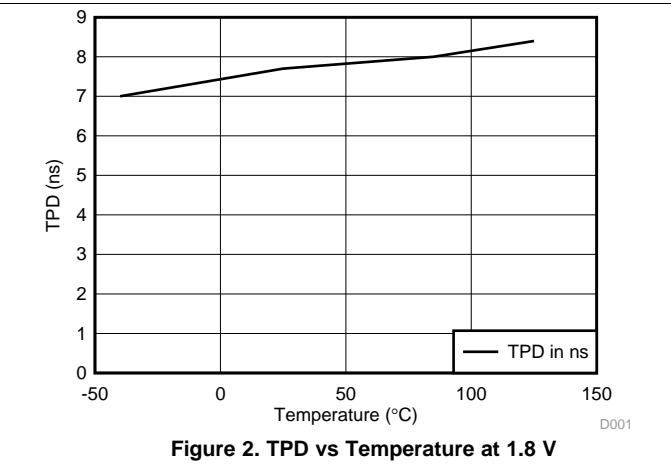
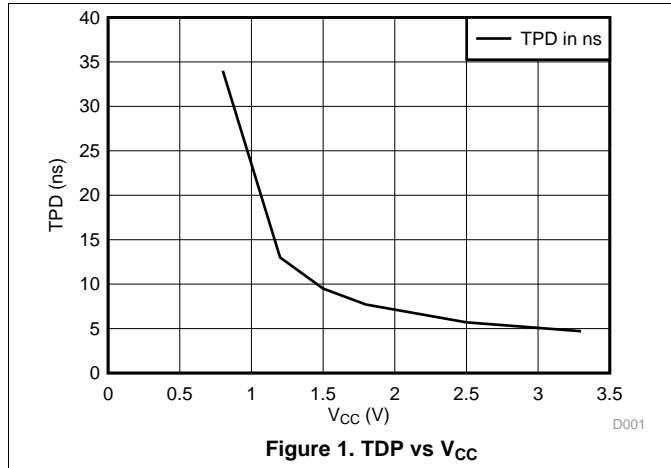

## 7 Parameter Measurement Information

### 7.1 Propagation Delays, Setup and Hold Times, and Pulse Duration

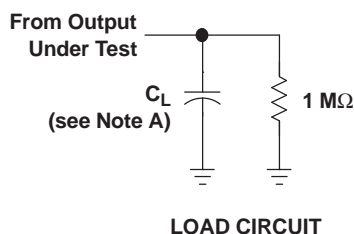

	$V_{CC} = 0.8\text{ V}$	$V_{CC} = 1.2\text{ V}$ $\pm 0.1\text{ V}$	$V_{CC} = 1.5\text{ V}$ $\pm 0.1\text{ V}$	$V_{CC} = 1.8\text{ V}$ $\pm 0.15\text{ V}$	$V_{CC} = 2.5\text{ V}$ $\pm 0.2\text{ V}$	$V_{CC} = 3.3\text{ V}$ $\pm 0.3\text{ V}$
$C_L$	5, 10, 15, 30 pF	5, 10, 15, 30 pF	5, 10, 15, 30 pF	5, 10, 15, 30 pF	5, 10, 15, 30 pF	5, 10, 15, 30 pF
$V_M$	$V_{CC}/2$	$V_{CC}/2$	$V_{CC}/2$	$V_{CC}/2$	$V_{CC}/2$	$V_{CC}/2$
$V_I$	$V_{CC}$	$V_{CC}$	$V_{CC}$	$V_{CC}$	$V_{CC}$	$V_{CC}$

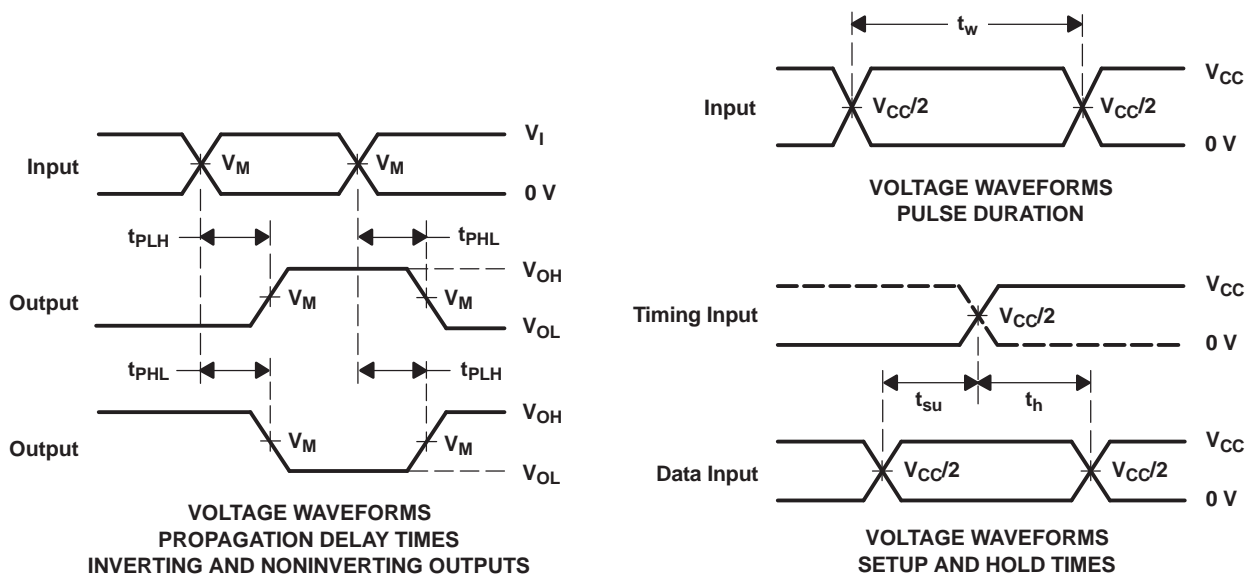

- NOTES:
- A.  $C_L$  includes probe and jig capacitance.
  - B. All input pulses are supplied by generators having the following characteristics:  $PRR \leq 10\text{ MHz}$ ,  $Z_O = 50\ \Omega$ ,  $t_r/t_f = 3\text{ ns}$ .
  - C. The outputs are measured one at a time, with one transition per measurement.
  - D.  $t_{PLH}$  and  $t_{PHL}$  are the same as  $t_{pd}$ .
  - E. All parameters and waveforms are not applicable to all devices.

Figure 3. Load Circuit and Voltage Waveforms

## 7.2 Enable and Disable Times

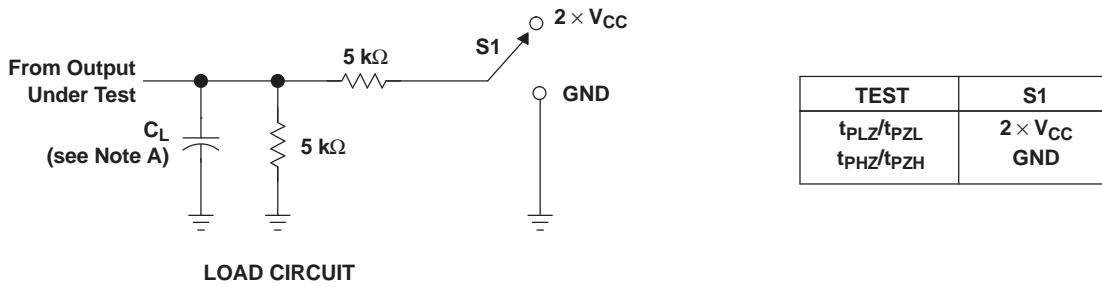

	$V_{CC} = 0.8 \text{ V}$	$V_{CC} = 1.2 \text{ V}$ $\pm 0.1 \text{ V}$	$V_{CC} = 1.5 \text{ V}$ $\pm 0.1 \text{ V}$	$V_{CC} = 1.8 \text{ V}$ $\pm 0.15 \text{ V}$	$V_{CC} = 2.5 \text{ V}$ $\pm 0.2 \text{ V}$	$V_{CC} = 3.3 \text{ V}$ $\pm 0.3 \text{ V}$
$C_L$	5, 10, 15, 30 pF	5, 10, 15, 30 pF	5, 10, 15, 30 pF	5, 10, 15, 30 pF	5, 10, 15, 30 pF	5, 10, 15, 30 pF
$V_M$	$V_{CC}/2$	$V_{CC}/2$	$V_{CC}/2$	$V_{CC}/2$	$V_{CC}/2$	$V_{CC}/2$
$V_I$	$V_{CC}$	$V_{CC}$	$V_{CC}$	$V_{CC}$	$V_{CC}$	$V_{CC}$
$V_{\Delta}$	0.1 V	0.1 V	0.1 V	0.15 V	0.15 V	0.3 V

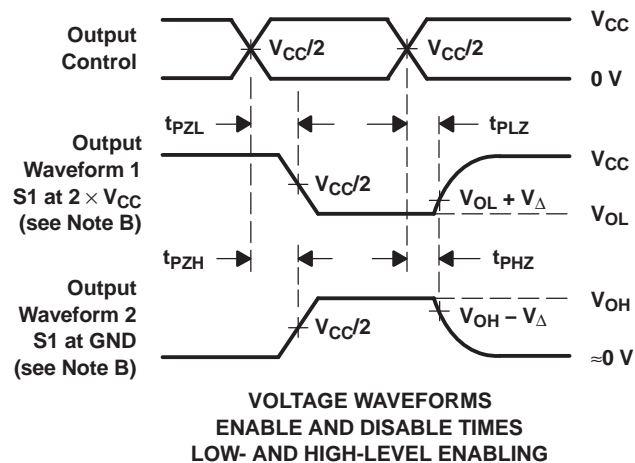

- NOTES:
- $C_L$  includes probe and jig capacitance.
  - Waveform 1 is for an output with internal conditions such that the output is low, except when disabled by the output control. Waveform 2 is for an output with internal conditions such that the output is high, except when disabled by the output control.
  - All input pulses are supplied by generators having the following characteristics:  $PRR \leq 10 \text{ MHz}$ ,  $Z_O = 50 \Omega$ ,  $t_r/t_f = 3 \text{ ns}$ .
  - The outputs are measured one at a time, with one transition per measurement.
  - $t_{PLZ}$  and  $t_{PHZ}$  are the same as  $t_{dis}$ .
  - $t_{PZL}$  and  $t_{PZH}$  are the same as  $t_{en}$ .
  - All parameters and waveforms are not applicable to all devices.

**Figure 4. Load Circuit and Voltage Waveforms**

## 8 Detailed Description

### 8.1 Overview

The SN74LVC1G02 device contains one 2-input positive-NOR gate and performs the Boolean function  $Y = \overline{A + B}$  or  $Y = \overline{A} \times \overline{B}$ .

The AUP family of devices has quiescent power consumption less than 1  $\mu$ A and comes in the ultra small DPW package. The DPW package technology is a major breakthrough in IC packaging. Its tiny 0.64 mm square footprint saves significant board space over other package options while still retaining the traditional manufacturing friendly lead pitch of 0.5 mm.

This device is fully specified for partial-power-down applications using  $I_{off}$ . The  $I_{off}$  circuitry disables the outputs, preventing damaging current backflow through the device when it is powered. The  $I_{off}$  feature also allows for live insertion.

### 8.2 Functional Block Diagram



### 8.3 Feature Description

- Wide operating  $V_{CC}$  range of 0.8 V to 3.6 V
- 3.6-V I/O tolerant to support down translation
- Input hysteresis allows slow input transition and better switching noise immunity at the input
- $I_{off}$  feature allows voltages on the inputs and outputs when  $V_{CC}$  is 0 V
- Low noise due to slower edge rates

### 8.4 Device Functional Modes

Table 1 shows the functional modes of SN74AUP1G02.

Table 1. Function Table

INPUTS		OUTPUT Y
A	B	
L	L	H
L	H	L
H	L	L
H	H	L

## 9 Application and Implementation

### NOTE

Information in the following applications sections is not part of the TI component specification, and TI does not warrant its accuracy or completeness. TI's customers are responsible for determining suitability of components for their purposes. Customers should validate and test their design implementation to confirm system functionality.

### 9.1 Application Information

The AUP family is TI's premier solution to the industry's low-power needs in battery-powered portable applications. This family ensures a very low static and dynamic power consumption across the entire  $V_{CC}$  range of 0.8 V to 3.6 V, resulting in an increased battery life. This product also maintains excellent signal integrity. It has a small amount of hysteresis built in allowing for slower or noisy input signals. The lowered drive produces slower edges and prevents overshoot and undershoot on the outputs.

### 9.2 Typical Application

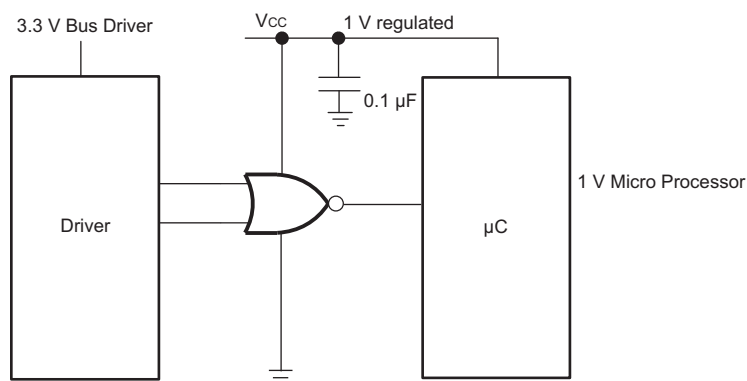

**Figure 5. Typical Application Schematic**

#### 9.2.1 Design Requirements

This device uses CMOS technology and has balanced output drive. Care should be taken to avoid bus contention because it can drive currents that would exceed maximum limits.

#### 9.2.2 Detailed Design Procedure

1. Recommended Input conditions
  - Rise time and fall time specs. See  $(\Delta t/\Delta V)$  in [Recommended Operating Conditions](#)
  - Specified high and low levels. See  $(V_{IH}$  and  $V_{IL})$  in [Recommended Operating Conditions](#)
  - Inputs are overvoltage tolerant allowing them to go as high as 3.6 V at any valid  $V_{CC}$
2. Recommend output conditions
  - Load currents should not exceed 20 mA on the output and 50 mA total for the part
  - Outputs should not be pulled above  $V_{CC}$

**Typical Application (continued)**

**9.2.3 Application Curves**

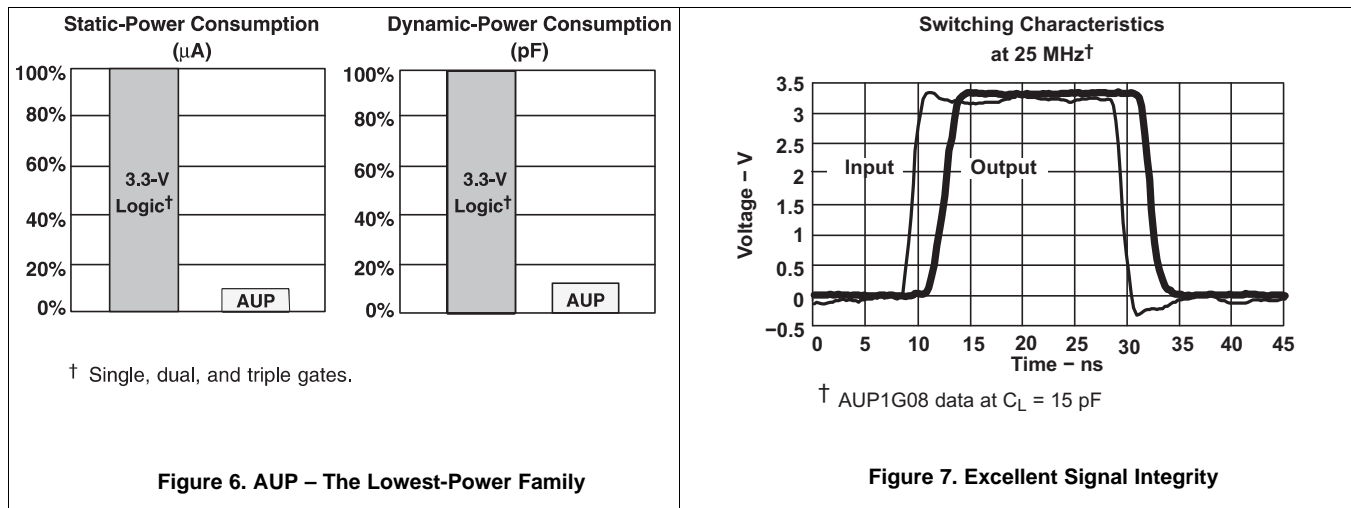

The AUP family of single gate logic makes excellent translators for the new lower voltage microprocessors that typically are powered from 0.8 V to 1.2 V. They can drop the voltage of peripheral drivers and accessories that are still powered by 3.3 V to the new uC power levels.

## 10 Power Supply Recommendations

The power supply can be any voltage between the Min and Max supply voltage rating located in the [Recommended Operating Conditions](#) table.

Each  $V_{CC}$  pin should have a good bypass capacitor to prevent power disturbance. For devices with a single supply, 0.1  $\mu\text{F}$  is recommended; if there are multiple  $V_{CC}$  pins, then 0.01  $\mu\text{F}$  or 0.022  $\mu\text{F}$  is recommended for each power pin. It is acceptable to parallel multiple bypass caps to reject different frequencies of noise. A 0.1  $\mu\text{F}$  and a 1  $\mu\text{F}$  are commonly used in parallel. The bypass capacitor should be installed as close to the power pin as possible for best results.

## 11 Layout

### 11.1 Layout Guidelines

In many cases, functions or parts of functions of digital logic devices are unused, for example, when only two inputs of a triple-input AND gate are used or only 3 of the 4 buffer gates are used. Such input pins should not be left unconnected because the undefined voltages at the outside connections result in undefined operational states. [Figure 8](#) specifies the rules that must be observed under all circumstances. All unused inputs of digital logic devices must be connected to a high or low bias to prevent them from floating. The logic level that should be applied to any particular unused input depends on the function of the device. Generally they will be tied to GND or  $V_{CC}$ , whichever makes more sense or is more convenient. It is generally acceptable to float outputs, unless the part is a transceiver. If the transceiver has an output enable pin, it will disable the output section of the part when asserted. This will not disable the input section of the I/Os, so they cannot float when disabled.

### 11.2 Layout Example

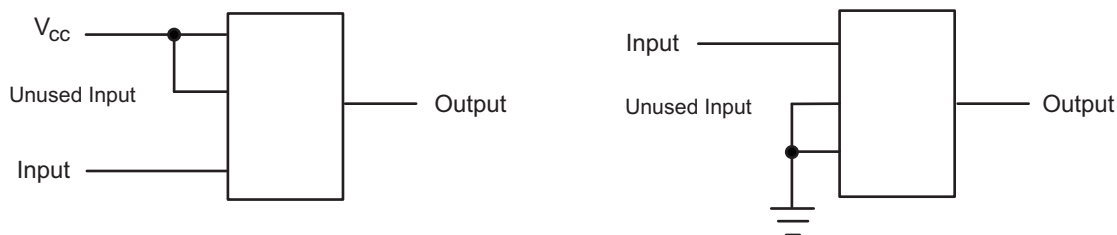

**Figure 8. Layout Diagram**

## 12 Device and Documentation Support

### 12.1 Receiving Notification of Documentation Updates

To receive notification of documentation updates, navigate to the device product folder on ti.com. In the upper right corner, click on *Alert me* to register and receive a weekly digest of any product information that has changed. For change details, review the revision history included in any revised document.

### 12.2 Community Resources

The following links connect to TI community resources. Linked contents are provided "AS IS" by the respective contributors. They do not constitute TI specifications and do not necessarily reflect TI's views; see TI's [Terms of Use](#).

**TI E2E™ Online Community** *TI's Engineer-to-Engineer (E2E) Community*. Created to foster collaboration among engineers. At e2e.ti.com, you can ask questions, share knowledge, explore ideas and help solve problems with fellow engineers.

**Design Support** *TI's Design Support* Quickly find helpful E2E forums along with design support tools and contact information for technical support.

### 12.3 Trademarks

E2E is a trademark of Texas Instruments.  
All other trademarks are the property of their respective owners.

### 12.4 Electrostatic Discharge Caution



These devices have limited built-in ESD protection. The leads should be shorted together or the device placed in conductive foam during storage or handling to prevent electrostatic damage to the MOS gates.

### 12.5 Glossary

[SLYZ022](#) — *TI Glossary*.

This glossary lists and explains terms, acronyms, and definitions.

## 13 Mechanical, Packaging, and Orderable Information

The following pages include mechanical, packaging, and orderable information. This information is the most current data available for the designated devices. This data is subject to change without notice and revision of this document. For browser-based versions of this data sheet, refer to the left-hand navigation.

**PACKAGING INFORMATION**

Orderable part number	Status (1)	Material type (2)	Package   Pins	Package qty   Carrier	RoHS (3)	Lead finish/ Ball material (4)	MSL rating/ Peak reflow (5)	Op temp (°C)	Part marking (6)
<a href="#">SN74AUP1G02DBVR</a>	Active	Production	SOT-23 (DBV)   5	3000   LARGE T&R	Yes	NIPDAU	Level-1-260C-UNLIM	-40 to 85	H02R
SN74AUP1G02DBVR.B	Active	Production	SOT-23 (DBV)   5	3000   LARGE T&R	Yes	NIPDAU	Level-1-260C-UNLIM	-40 to 85	H02R
SN74AUP1G02DBVRG4	Active	Production	SOT-23 (DBV)   5	3000   LARGE T&R	Yes	NIPDAU	Level-1-260C-UNLIM	-40 to 85	H02R
SN74AUP1G02DBVRG4.B	Active	Production	SOT-23 (DBV)   5	3000   LARGE T&R	Yes	NIPDAU	Level-1-260C-UNLIM	-40 to 85	H02R
<a href="#">SN74AUP1G02DBVT</a>	Active	Production	SOT-23 (DBV)   5	250   SMALL T&R	Yes	NIPDAU	Level-1-260C-UNLIM	-40 to 85	H02R
SN74AUP1G02DBVT.B	Active	Production	SOT-23 (DBV)   5	250   SMALL T&R	Yes	NIPDAU	Level-1-260C-UNLIM	-40 to 85	H02R
<a href="#">SN74AUP1G02DCKR</a>	Active	Production	SC70 (DCK)   5	3000   LARGE T&R	Yes	NIPDAU   SN	Level-1-260C-UNLIM	-40 to 85	(HB5, HBF, HBR)
SN74AUP1G02DCKR.B	Active	Production	SC70 (DCK)   5	3000   LARGE T&R	Yes	SN	Level-1-260C-UNLIM	-40 to 85	(HB5, HBF, HBR)
<a href="#">SN74AUP1G02DCKRG4</a>	Active	Production	SC70 (DCK)   5	3000   LARGE T&R	Yes	NIPDAU	Level-1-260C-UNLIM	-40 to 85	(HB5, HBF, HBR)
SN74AUP1G02DCKRG4.B	Active	Production	SC70 (DCK)   5	3000   LARGE T&R	Yes	NIPDAU	Level-1-260C-UNLIM	-40 to 85	(HB5, HBF, HBR)
<a href="#">SN74AUP1G02DCKT</a>	Active	Production	SC70 (DCK)   5	250   SMALL T&R	Yes	NIPDAU	Level-1-260C-UNLIM	-40 to 85	(HB5, HBR)
SN74AUP1G02DCKT.B	Active	Production	SC70 (DCK)   5	250   SMALL T&R	Yes	NIPDAU	Level-1-260C-UNLIM	-40 to 85	(HB5, HBR)
<a href="#">SN74AUP1G02DPWR</a>	Active	Production	X2SON (DPW)   5	3000   LARGE T&R	Yes	NIPDAU	Level-1-260C-UNLIM	-40 to 85	(B, B4)
SN74AUP1G02DPWR.B	Active	Production	X2SON (DPW)   5	3000   LARGE T&R	Yes	NIPDAU	Level-1-260C-UNLIM	-40 to 85	(B, B4)
SN74AUP1G02DPWRG4.B	Active	Production	X2SON (DPW)   5	3000   LARGE T&R	-	Call TI	Call TI	-40 to 85	
<a href="#">SN74AUP1G02DRLR</a>	Active	Production	SOT-5X3 (DRL)   5	4000   LARGE T&R	Yes	NIPDAU   NIPDAUAG	Level-1-260C-UNLIM	-40 to 85	(HB7, HBR)
SN74AUP1G02DRLR.B	Active	Production	SOT-5X3 (DRL)   5	4000   LARGE T&R	Yes	NIPDAUAG	Level-1-260C-UNLIM	-40 to 85	(HB7, HBR)
<a href="#">SN74AUP1G02DRY2</a>	Active	Production	SON (DRY)   6	5000   LARGE T&R	Yes	NIPDAU	Level-1-260C-UNLIM	-40 to 85	HB
SN74AUP1G02DRY2.B	Active	Production	SON (DRY)   6	5000   LARGE T&R	Yes	NIPDAU	Level-1-260C-UNLIM	-40 to 85	HB
<a href="#">SN74AUP1G02DRYR</a>	Active	Production	SON (DRY)   6	5000   LARGE T&R	Yes	NIPDAU   NIPDAUAG	Level-1-260C-UNLIM	-40 to 85	HB
SN74AUP1G02DRYR.B	Active	Production	SON (DRY)   6	5000   LARGE T&R	Yes	NIPDAUAG	Level-1-260C-UNLIM	-40 to 85	HB
SN74AUP1G02DRYRG4	Active	Production	SON (DRY)   6	5000   LARGE T&R	Yes	NIPDAU	Level-1-260C-UNLIM	-40 to 85	HB
SN74AUP1G02DRYRG4.B	Active	Production	SON (DRY)   6	5000   LARGE T&R	Yes	NIPDAU	Level-1-260C-UNLIM	-40 to 85	HB
<a href="#">SN74AUP1G02DSFR</a>	Active	Production	SON (DSF)   6	5000   LARGE T&R	Yes	NIPDAU   NIPDAUAG	Level-1-260C-UNLIM	-40 to 85	HB
SN74AUP1G02DSFR.B	Active	Production	SON (DSF)   6	5000   LARGE T&R	Yes	NIPDAU	Level-1-260C-UNLIM	-40 to 85	HB
SN74AUP1G02DSFRG4	Active	Production	SON (DSF)   6	5000   LARGE T&R	Yes	NIPDAU	Level-1-260C-UNLIM	-40 to 85	HB
SN74AUP1G02DSFRG4.B	Active	Production	SON (DSF)   6	5000   LARGE T&R	Yes	NIPDAU	Level-1-260C-UNLIM	-40 to 85	HB
<a href="#">SN74AUP1G02YFPR</a>	Active	Production	DSBGA (YFP)   6	3000   LARGE T&R	Yes	SNAGCU	Level-1-260C-UNLIM	-	HBN
SN74AUP1G02YFPR.B	Active	Production	DSBGA (YFP)   6	3000   LARGE T&R	Yes	SNAGCU	Level-1-260C-UNLIM	-40 to 85	HBN

- (1) **Status:** For more details on status, see our [product life cycle](#).
- (2) **Material type:** When designated, preproduction parts are prototypes/experimental devices, and are not yet approved or released for full production. Testing and final process, including without limitation quality assurance, reliability performance testing, and/or process qualification, may not yet be complete, and this item is subject to further changes or possible discontinuation. If available for ordering, purchases will be subject to an additional waiver at checkout, and are intended for early internal evaluation purposes only. These items are sold without warranties of any kind.
- (3) **RoHS values:** Yes, No, RoHS Exempt. See the [TI RoHS Statement](#) for additional information and value definition.
- (4) **Lead finish/Ball material:** Parts may have multiple material finish options. Finish options are separated by a vertical ruled line. Lead finish/Ball material values may wrap to two lines if the finish value exceeds the maximum column width.
- (5) **MSL rating/Peak reflow:** The moisture sensitivity level ratings and peak solder (reflow) temperatures. In the event that a part has multiple moisture sensitivity ratings, only the lowest level per JEDEC standards is shown. Refer to the shipping label for the actual reflow temperature that will be used to mount the part to the printed circuit board.
- (6) **Part marking:** There may be an additional marking, which relates to the logo, the lot trace code information, or the environmental category of the part.

Multiple part markings will be inside parentheses. Only one part marking contained in parentheses and separated by a "~" will appear on a part. If a line is indented then it is a continuation of the previous line and the two combined represent the entire part marking for that device.

**Important Information and Disclaimer:** The information provided on this page represents TI's knowledge and belief as of the date that it is provided. TI bases its knowledge and belief on information provided by third parties, and makes no representation or warranty as to the accuracy of such information. Efforts are underway to better integrate information from third parties. TI has taken and continues to take reasonable steps to provide representative and accurate information but may not have conducted destructive testing or chemical analysis on incoming materials and chemicals. TI and TI suppliers consider certain information to be proprietary, and thus CAS numbers and other limited information may not be available for release.

In no event shall TI's liability arising out of such information exceed the total purchase price of the TI part(s) at issue in this document sold by TI to Customer on an annual basis.

**TAPE AND REEL INFORMATION**

**QUADRANT ASSIGNMENTS FOR PIN 1 ORIENTATION IN TAPE**

\*All dimensions are nominal

Device	Package Type	Package Drawing	Pins	SPQ	Reel Diameter (mm)	Reel Width W1 (mm)	A0 (mm)	B0 (mm)	K0 (mm)	P1 (mm)	W (mm)	Pin1 Quadrant
SN74AUP1G02DBVR	SOT-23	DBV	5	3000	180.0	8.4	3.23	3.17	1.37	4.0	8.0	Q3
SN74AUP1G02DBVRG4	SOT-23	DBV	5	3000	180.0	8.4	3.23	3.17	1.37	4.0	8.0	Q3
SN74AUP1G02DBVT	SOT-23	DBV	5	250	180.0	8.4	3.23	3.17	1.37	4.0	8.0	Q3
SN74AUP1G02DCKR	SC70	DCK	5	3000	180.0	8.4	2.3	2.5	1.2	4.0	8.0	Q3
SN74AUP1G02DCKR	SC70	DCK	5	3000	178.0	8.4	2.25	2.45	1.2	4.0	8.0	Q3
SN74AUP1G02DCKRG4	SC70	DCK	5	3000	178.0	9.2	2.4	2.4	1.22	4.0	8.0	Q3
SN74AUP1G02DCKRG4	SC70	DCK	5	3000	180.0	8.4	2.47	2.3	1.25	4.0	8.0	Q3
SN74AUP1G02DCKT	SC70	DCK	5	250	178.0	9.2	2.4	2.4	1.22	4.0	8.0	Q3
SN74AUP1G02DCKT	SC70	DCK	5	250	180.0	8.4	2.47	2.3	1.25	4.0	8.0	Q3
SN74AUP1G02DPWR	X2SON	DPW	5	3000	178.0	8.4	0.91	0.91	0.5	2.0	8.0	Q3
SN74AUP1G02DRLR	SOT-5X3	DRL	5	4000	180.0	8.4	1.98	1.78	0.69	4.0	8.0	Q3
SN74AUP1G02DRY2	SON	DRY	6	5000	180.0	9.5	1.6	1.15	0.75	4.0	8.0	Q3
SN74AUP1G02DRYR	SON	DRY	6	5000	180.0	9.5	1.15	1.6	0.75	4.0	8.0	Q1
SN74AUP1G02DRYRG4	SON	DRY	6	5000	180.0	9.5	1.15	1.6	0.75	4.0	8.0	Q1
SN74AUP1G02DSFR	SON	DSF	6	5000	180.0	8.4	1.16	1.16	0.5	4.0	8.0	Q2
SN74AUP1G02DSFRG4	SON	DSF	6	5000	180.0	8.4	1.16	1.16	0.5	4.0	8.0	Q2

---

Device	Package Type	Package Drawing	Pins	SPQ	Reel Diameter (mm)	Reel Width W1 (mm)	A0 (mm)	B0 (mm)	K0 (mm)	P1 (mm)	W (mm)	Pin1 Quadrant
SN74AUP1G02YFPR	DSBGA	YFP	6	3000	178.0	9.2	0.89	1.29	0.62	4.0	8.0	Q1

**TAPE AND REEL BOX DIMENSIONS**

\*All dimensions are nominal

Device	Package Type	Package Drawing	Pins	SPQ	Length (mm)	Width (mm)	Height (mm)
SN74AUP1G02DBVR	SOT-23	DBV	5	3000	202.0	201.0	28.0
SN74AUP1G02DBVRG4	SOT-23	DBV	5	3000	202.0	201.0	28.0
SN74AUP1G02DBVT	SOT-23	DBV	5	250	202.0	201.0	28.0
SN74AUP1G02DCKR	SC70	DCK	5	3000	210.0	185.0	35.0
SN74AUP1G02DCKR	SC70	DCK	5	3000	208.0	191.0	35.0
SN74AUP1G02DCKRG4	SC70	DCK	5	3000	180.0	180.0	18.0
SN74AUP1G02DCKRG4	SC70	DCK	5	3000	202.0	201.0	28.0
SN74AUP1G02DCKT	SC70	DCK	5	250	180.0	180.0	18.0
SN74AUP1G02DCKT	SC70	DCK	5	250	202.0	201.0	28.0
SN74AUP1G02DPWR	X2SON	DPW	5	3000	205.0	200.0	33.0
SN74AUP1G02DRLR	SOT-5X3	DRL	5	4000	202.0	201.0	28.0
SN74AUP1G02DRY2	SON	DRY	6	5000	184.0	184.0	19.0
SN74AUP1G02DRYR	SON	DRY	6	5000	184.0	184.0	19.0
SN74AUP1G02DRYRG4	SON	DRY	6	5000	184.0	184.0	19.0
SN74AUP1G02DSFR	SON	DSF	6	5000	210.0	185.0	35.0
SN74AUP1G02DSFRG4	SON	DSF	6	5000	210.0	185.0	35.0
SN74AUP1G02YFPR	DSBGA	YFP	6	3000	220.0	220.0	35.0



# EXAMPLE BOARD LAYOUT

DBV0005A

SOT-23 - 1.45 mm max height

SMALL OUTLINE TRANSISTOR



LAND PATTERN EXAMPLE  
EXPOSED METAL SHOWN  
SCALE:15X



SOLDER MASK DETAILS

4214839/K 08/2024

NOTES: (continued)

- 6. Publication IPC-7351 may have alternate designs.
- 7. Solder mask tolerances between and around signal pads can vary based on board fabrication site.

# EXAMPLE STENCIL DESIGN

DBV0005A

SOT-23 - 1.45 mm max height

SMALL OUTLINE TRANSISTOR



SOLDER PASTE EXAMPLE  
BASED ON 0.125 mm THICK STENCIL  
SCALE:15X

4214839/K 08/2024

NOTES: (continued)

8. Laser cutting apertures with trapezoidal walls and rounded corners may offer better paste release. IPC-7525 may have alternate design recommendations.
9. Board assembly site may have different recommendations for stencil design.

## GENERIC PACKAGE VIEW

**DRY 6**

**USON - 0.6 mm max height**

PLASTIC SMALL OUTLINE - NO LEAD



Images above are just a representation of the package family, actual package may vary.  
Refer to the product data sheet for package details.

4207181/G



# EXAMPLE BOARD LAYOUT

DRY0006A

USON - 0.6 mm max height

PLASTIC SMALL OUTLINE - NO LEAD



**LAND PATTERN EXAMPLE**  
1:1 RATIO WITH PKG SOLDER PADS  
EXPOSED METAL SHOWN  
SCALE:40X



**SOLDER MASK DETAILS**

4222894/A 01/2018

NOTES: (continued)

3. For more information, see QFN/SON PCB application report in literature No. SLUA271 ([www.ti.com/lit/slua271](http://www.ti.com/lit/slua271)).

# EXAMPLE STENCIL DESIGN

DRY0006A

USON - 0.6 mm max height

PLASTIC SMALL OUTLINE - NO LEAD



SOLDER PASTE EXAMPLE  
BASED ON 0.075 - 0.1 mm THICK STENCIL  
SCALE:40X

4222894/A 01/2018

NOTES: (continued)

4. Laser cutting apertures with trapezoidal walls and rounded corners may offer better paste release. IPC-7525 may have alternate design recommendations.



**DSF0006A**

**PACKAGE OUTLINE**

**X2SON - 0.4 mm max height**

PLASTIC SMALL OUTLINE - NO LEAD



**NOTES:**

1. All linear dimensions are in millimeters. Any dimensions in parenthesis are for reference only. Dimensioning and tolerancing per ASME Y14.5M.
2. This drawing is subject to change without notice.
3. Reference JEDEC registration MO-287, variation X2AAF.

# EXAMPLE BOARD LAYOUT

DSF0006A

X2SON - 0.4 mm max height

PLASTIC SMALL OUTLINE - NO LEAD

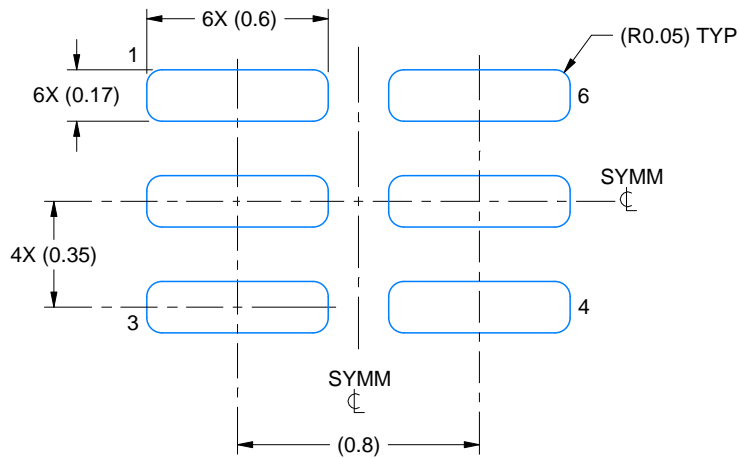

LAND PATTERN EXAMPLE  
EXPOSED METAL SHOWN  
SCALE:40X



SOLDER MASK DETAILS

4220597/B 06/2022

NOTES: (continued)

4. For more information, see Texas Instruments literature number SLUA271 ([www.ti.com/lit/slua271](http://www.ti.com/lit/slua271)).

# EXAMPLE STENCIL DESIGN

DSF0006A

X2SON - 0.4 mm max height

PLASTIC SMALL OUTLINE - NO LEAD



SOLDER PASTE EXAMPLE  
BASED ON 0.09 mm THICK STENCIL

PRINTED SOLDER COVERAGE BY AREA UNDER PACKAGE  
SCALE:40X

4220597/B 06/2022

4. Laser cutting apertures with trapezoidal walls and rounded corners may offer better paste release. IPC-7525 may have alternate design recommendations.



4220753/E 11/2024

NOTES:

1. All linear dimensions are in millimeters. Any dimensions in parenthesis are for reference only. Dimensioning and tolerancing per ASME Y14.5M.
2. This drawing is subject to change without notice.
3. This dimension does not include mold flash, protrusions, or gate burrs. Mold flash, protrusions, or gate burrs shall not exceed 0.15 mm per side.
4. Reference JEDEC registration MO-293 Variation UAAD-1

# EXAMPLE BOARD LAYOUT

DRL0005A

SOT - 0.6 mm max height

PLASTIC SMALL OUTLINE



LAND PATTERN EXAMPLE  
SCALE:30X



SOLDERMASK DETAILS

4220753/E 11/2024

NOTES: (continued)

- 5. Publication IPC-7351 may have alternate designs.
- 6. Solder mask tolerances between and around signal pads can vary based on board fabrication site.

# EXAMPLE STENCIL DESIGN

DRL0005A

SOT - 0.6 mm max height

PLASTIC SMALL OUTLINE



SOLDER PASTE EXAMPLE  
BASED ON 0.1 mm THICK STENCIL  
SCALE:30X

4220753/E 11/2024

NOTES: (continued)

7. Laser cutting apertures with trapezoidal walls and rounded corners may offer better paste release. IPC-7525 may have alternate design recommendations.
8. Board assembly site may have different recommendations for stencil design.

## GENERIC PACKAGE VIEW

DPW 5

X2SON - 0.4 mm max height

PLASTIC SMALL OUTLINE - NO LEAD



Images above are just a representation of the package family, actual package may vary.  
Refer to the product data sheet for package details.

4211218-3/D



4223102/D 03/2022

NOTES:

1. All linear dimensions are in millimeters. Any dimensions in parenthesis are for reference only. Dimensioning and tolerancing per ASME Y14.5M.
2. This drawing is subject to change without notice.
3. The size and shape of this feature may vary.

# EXAMPLE BOARD LAYOUT

DPW0005A

X2SON - 0.4 mm max height

PLASTIC SMALL OUTLINE - NO LEAD



LAND PATTERN EXAMPLE  
SOLDER MASK DEFINED  
SCALE:60X

4223102/D 03/2022

NOTES: (continued)

4. This package is designed to be soldered to a thermal pad on the board. For more information, refer to QFN/SON PCB application note in literature No. SLUA271 ([www.ti.com/lit/sl原因271](http://www.ti.com/lit/sl原因271)).

# EXAMPLE STENCIL DESIGN

DPW0005A

X2SON - 0.4 mm max height

PLASTIC SMALL OUTLINE - NO LEAD



SOLDER PASTE EXAMPLE  
BASED ON 0.1 mm THICK STENCIL

EXPOSED PAD 3  
92% PRINTED SOLDER COVERAGE BY AREA UNDER PACKAGE  
SCALE:100X

4223102/D 03/2022

NOTES: (continued)

5. Laser cutting apertures with trapezoidal walls and rounded corners may offer better paste release. IPC-7525 may have alternate design recommendations.

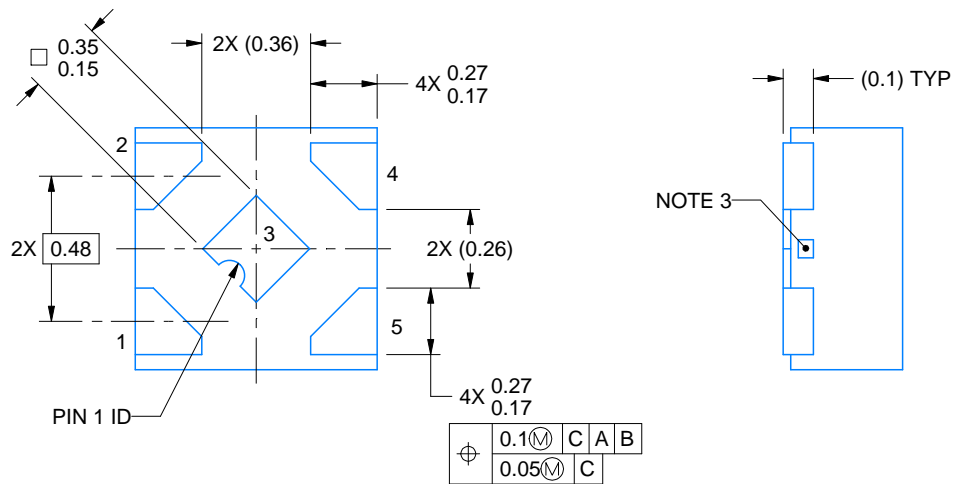
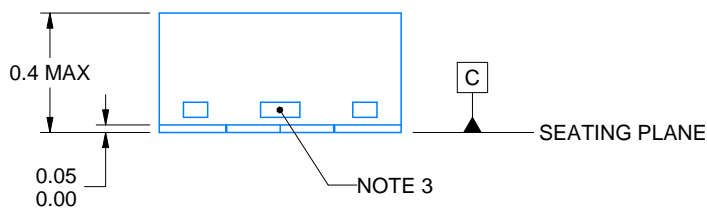
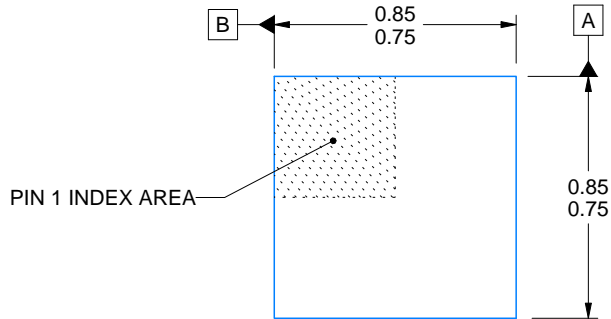

4228233/D 09/2023

NOTES:

1. All linear dimensions are in millimeters. Any dimensions in parenthesis are for reference only. Dimensioning and tolerancing per ASME Y14.5M.
2. This drawing is subject to change without notice.
3. The size and shape of this feature may vary.



# EXAMPLE STENCIL DESIGN

DPW0005B

X2SON - 0.4 mm max height

PLASTIC SMALL OUTLINE - NO LEAD



SOLDER PASTE EXAMPLE  
BASED ON 0.1 mm THICK STENCIL

EXPOSED PAD 5  
92% PRINTED SOLDER COVERAGE BY AREA UNDER PACKAGE  
SCALE:60X

4228233/D 09/2023

NOTES: (continued)

5. Laser cutting apertures with trapezoidal walls and rounded corners may offer better paste release. IPC-7525 may have alternate design recommendations.

YFP0006

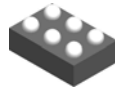

# PACKAGE OUTLINE

## DSBGA - 0.5 mm max height

DIE SIZE BALL GRID ARRAY

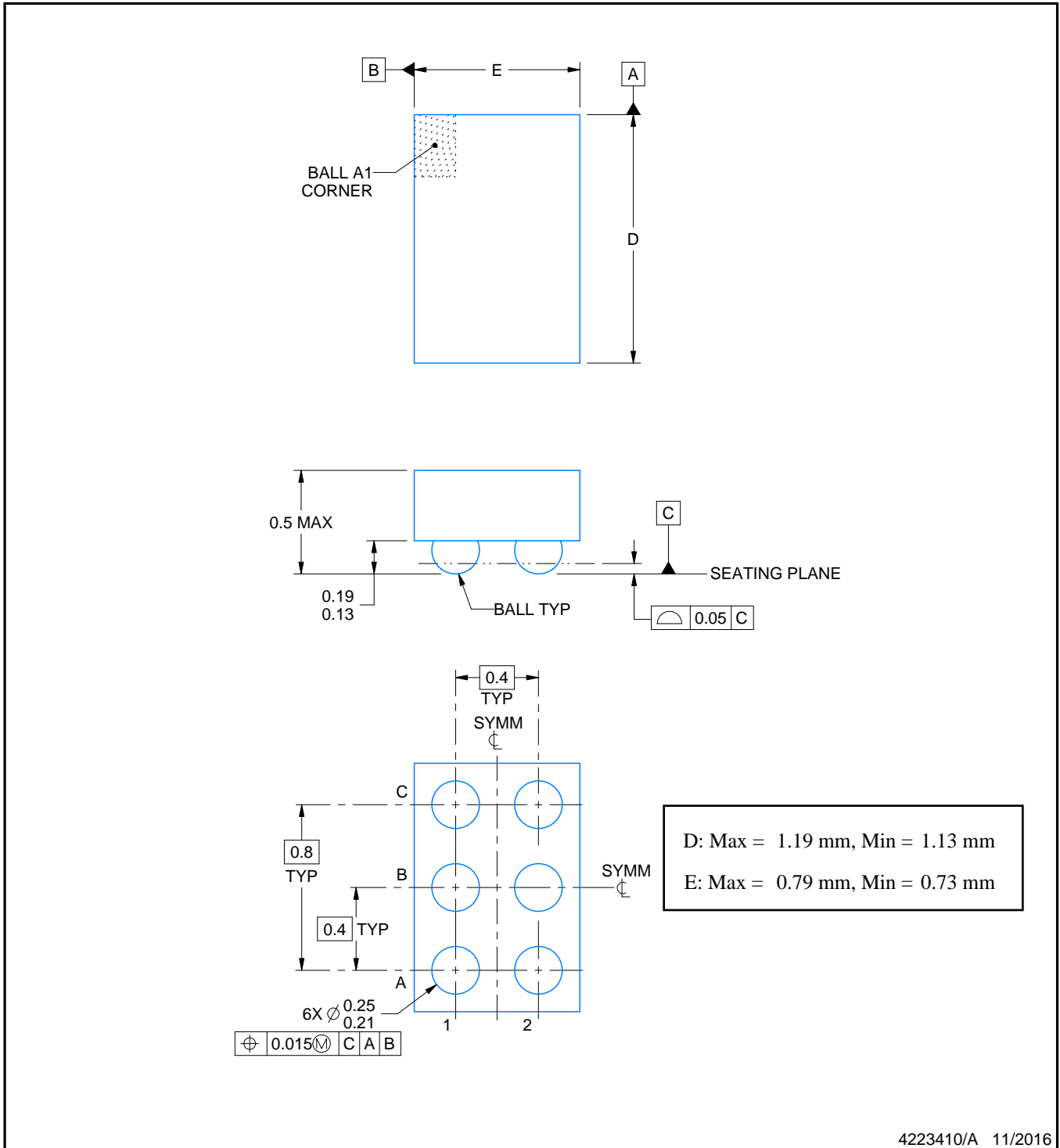

4223410/A 11/2016

NOTES:

1. All linear dimensions are in millimeters. Any dimensions in parenthesis are for reference only. Dimensioning and tolerancing per ASME Y14.5M.
2. This drawing is subject to change without notice.

# EXAMPLE BOARD LAYOUT

YFP0006

DSBGA - 0.5 mm max height

DIE SIZE BALL GRID ARRAY

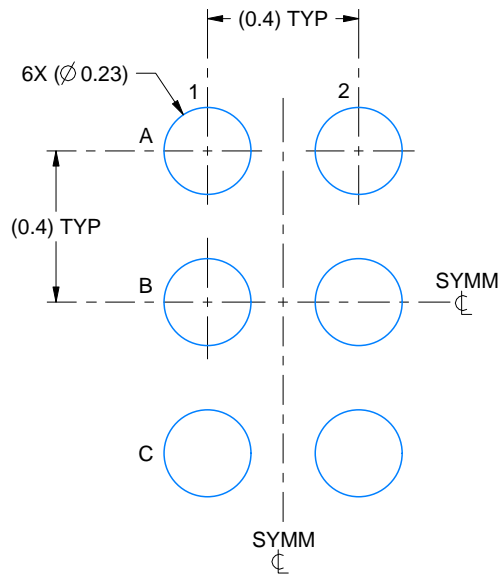

LAND PATTERN EXAMPLE  
SCALE:50X

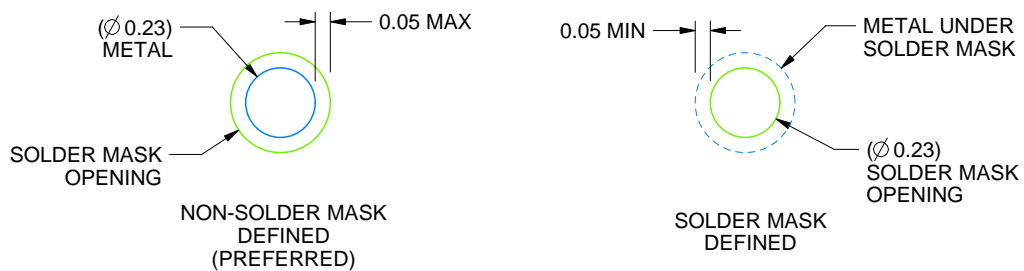

SOLDER MASK DETAILS  
NOT TO SCALE

4223410/A 11/2016

NOTES: (continued)

- Final dimensions may vary due to manufacturing tolerance considerations and also routing constraints. For more information, see Texas Instruments literature number SNVA009 ([www.ti.com/lit/snva009](http://www.ti.com/lit/snva009)).

# EXAMPLE STENCIL DESIGN

YFP0006

DSBGA - 0.5 mm max height

DIE SIZE BALL GRID ARRAY

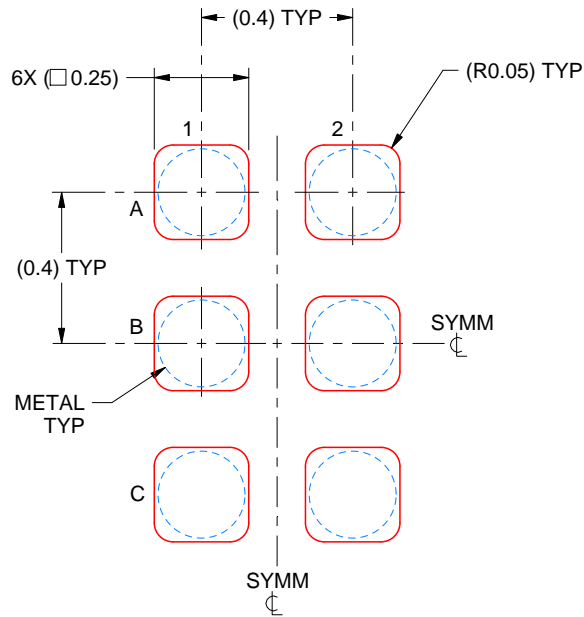

SOLDER PASTE EXAMPLE  
BASED ON 0.1 mm THICK STENCIL  
SCALE:50X

4223410/A 11/2016

NOTES: (continued)

4. Laser cutting apertures with trapezoidal walls and rounded corners may offer better paste release.



# EXAMPLE BOARD LAYOUT

DCK0005A

SOT - 1.1 max height

SMALL OUTLINE TRANSISTOR



LAND PATTERN EXAMPLE  
EXPOSED METAL SHOWN  
SCALE:18X

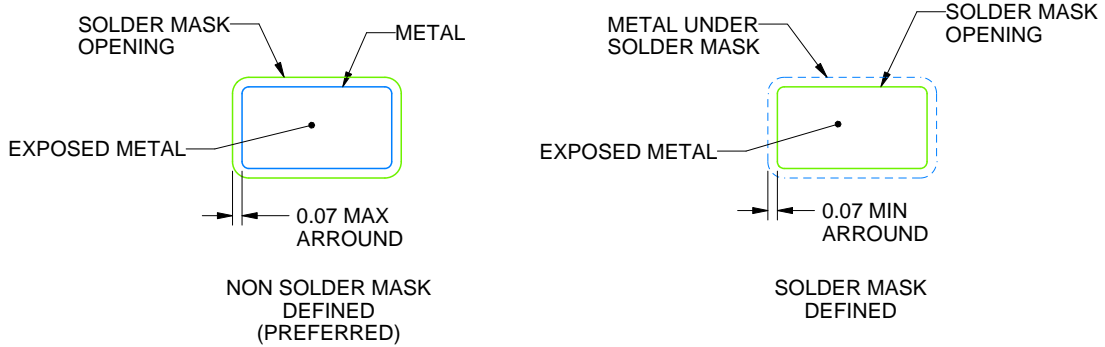

SOLDER MASK DETAILS

4214834/G 11/2024

NOTES: (continued)

- 7. Publication IPC-7351 may have alternate designs.
- 8. Solder mask tolerances between and around signal pads can vary based on board fabrication site.

# EXAMPLE STENCIL DESIGN

DCK0005A

SOT - 1.1 max height

SMALL OUTLINE TRANSISTOR



SOLDER PASTE EXAMPLE  
BASED ON 0.125 THICK STENCIL  
SCALE: 18X

4214834/G 11/2024

NOTES: (continued)

9. Laser cutting apertures with trapezoidal walls and rounded corners may offer better paste release. IPC-7525 may have alternate design recommendations.
10. Board assembly site may have different recommendations for stencil design.

## IMPORTANT NOTICE AND DISCLAIMER

TI PROVIDES TECHNICAL AND RELIABILITY DATA (INCLUDING DATASHEETS), DESIGN RESOURCES (INCLUDING REFERENCE DESIGNS), APPLICATION OR OTHER DESIGN ADVICE, WEB TOOLS, SAFETY INFORMATION, AND OTHER RESOURCES "AS IS" AND WITH ALL FAULTS, AND DISCLAIMS ALL WARRANTIES, EXPRESS AND IMPLIED, INCLUDING WITHOUT LIMITATION ANY IMPLIED WARRANTIES OF MERCHANTABILITY, FITNESS FOR A PARTICULAR PURPOSE OR NON-INFRINGEMENT OF THIRD PARTY INTELLECTUAL PROPERTY RIGHTS.

These resources are intended for skilled developers designing with TI products. You are solely responsible for (1) selecting the appropriate TI products for your application, (2) designing, validating and testing your application, and (3) ensuring your application meets applicable standards, and any other safety, security, regulatory or other requirements.

These resources are subject to change without notice. TI grants you permission to use these resources only for development of an application that uses the TI products described in the resource. Other reproduction and display of these resources is prohibited. No license is granted to any other TI intellectual property right or to any third party intellectual property right. TI disclaims responsibility for, and you fully indemnify TI and its representatives against any claims, damages, costs, losses, and liabilities arising out of your use of these resources.

TI's products are provided subject to [TI's Terms of Sale](#), [TI's General Quality Guidelines](#), or other applicable terms available either on [ti.com](http://ti.com) or provided in conjunction with such TI products. TI's provision of these resources does not expand or otherwise alter TI's applicable warranties or warranty disclaimers for TI products. Unless TI explicitly designates a product as custom or customer-specified, TI products are standard, catalog, general purpose devices.

TI objects to and rejects any additional or different terms you may propose.

Copyright © 2026, Texas Instruments Incorporated

Last updated 10/2025

## Looking for pricing, stock, or lifecycle information?

Click below to explore more details on WIN SOURCE:

 [View SN74AUP1G02YFPR on WIN SOURCE](#)

 [Texas Instruments](#) Information

## Optimize Your Supply Chain with WIN SOURCE Solutions

-  Global Sourcing Solution
-  Obsolete Management
-  Cost Control Management
-  Shortage Management
-  Alternative Solution
-  Excess Inventory Management