



**THE DATASHEET OF  
FXP14.07.0100A**





# TAOGLAS®



# Datasheet

## FXP14 Flexible PCB Cellular Antenna

**Part No:**  
FXP14.07.0100A

### Description

5G/4G Cellular Flexible PCB with 100mm 1.13 & IPEX MHFI Connector

### Features:

- Flexible PCB Antenna
- Dimensions: 70x20x0.2mm
- Connector: I-PEX MHF® I (U.FL Compatible)
- Cable: 100mm of Ø1.13
- Peel and Stick Mounting
- 3M 467 Adhesive
- CE Certified
- RoHS & REACH Compliant

<b>1.</b>	<b>Introduction</b>	<b>2</b>
<b>2.</b>	<b>Specification</b>	<b>3</b>
<b>3.</b>	<b>Antenna Characteristics</b>	<b>5</b>
<b>4.</b>	<b>Radiation Patterns</b>	<b>8</b>
<b>5.</b>	<b>Mechanical Drawing</b>	<b>17</b>
<b>6.</b>	<b>Packaging</b>	<b>18</b>
<hr/>		
	Changelog	19

Taoglas makes no warranties based on the accuracy or completeness of the contents of this document and reserves the right to make changes to specifications and product descriptions at any time without notice. Taoglas reserves all rights to this document and the information contained herein. Reproduction, use or disclosure to third parties without express permission is strictly prohibited.



# 1. Introduction



The Taoglas FXP14 Flexible Wideband Cellular Antenna covers all world-wide 5G/4G bands. The antenna has been designed in a flexible material with a rectangular form-factor and cable connection for an easy installation. The antenna works on different plastic materials and thickness. We have selected a piece of ABS with 2 mm of thickness as a baseline for testing.

### Typical Applications Include:

- Security
- Remote Monitoring
- Connected Health

The antenna has been designed using a super thin flexible polymer substrate with a rectangular form-factor and cable connection for ease of installation. The antenna radiates well on different plastic materials and thickness. We have selected ABS plastic mounting with 2 mm of thickness as a baseline for testing. Best in class efficiency on lower and upper bands (above 40%) make it an ideal antenna for devices where space for onboard SMD cellular antennas is not available.

The antenna is mounted via automotive quality 3M 467 adhesive and has excellent reliability. The FXP14 has its own ground-plane, therefore it does not need to connect to the ground-plane of the main-board of the device for improved radiation efficiency.

For more information or installation instructions, please contact your regional Taoglas customer support team.

## 2. Specification

Electrical								
Band	Frequency (MHz)	Efficiency (%)	Average Gain (dB)	Peak Gain (dBi)	Impedance	Polarization	Radiation Pattern	Input power
5G NR/4G Band 71	617-698	36.9	-4.33	-0.06	50 Ω	Linear	Omni	5W
4G/3G Band 12,13,14,17,28,29	698-806	46.2	-3.36	2.03				
4G/3G/NB-IoT/Cat M Band 5,8,18,19,20,26,27	824-960	58.1	-2.36	6.01				
5G NR/4G Band 21,32,74,75,76	1427-1518	51.5	-2.88	1.90				
4G/3G Band 1,2,3,4,9,23,25,35,39,6 6	1710-2200	70.5	-1.52	4.52				
4G/3G Band 7,30,38,40,41	2300-2690	29.5	-5.30	2.75				
5G NR/4G Band 22,42,48,77,78,79	3300-5000	52.7	-2.79	3.35				
LTE5200/Wi-Fi5800	5150-5925	49.0	-3.10	3.88				

Mechanical	
Dimensions	70 x 20 x 0.2mm
Weight	1.5g
Cable	100mm 1.13 Black
Connector	IPEX MHFI
Adhesive	3M 467

Environmental	
Temperature Range	40°C to 85°C
Humidity	Non-condensing 65°C 95% RH

5G/4G Bands			
Band Number	5G NR / FR1 / LTE / LTE-Advanced / WCDMA / HSPA / HSPA+ / TD-SCDMA		
	Uplink	Downlink	Covered
B1	1920 to 1980	2110 to 2170	✓
B2	1850 to 1910	1930 to 1990	✓
B3	1710 to 1785	1805 to 1880	✓
B4	1710 to 1755	2110 to 2155	✓
B5	824 to 849	869 to 894	✓
B7	2500 to 2570	2620 to 2690	✓
B8	880 to 915	925 to 960	✓
B9*	1749.9 to 1784.9	1844.9 to 1879.9	✓
B11	1427.9 to 1447.9	1475.9 to 1495.9	✓
B12	699 to 716	729 to 746	✓
B13	777 to 787	746 to 756	✓
B14	788 to 798	758 to 768	✓
B17	704 to 716	734 to 746	✓
B18	815 to 830	860 to 875	✓
B19	830 to 845	875 to 890	✓
B20	832 to 862	791 to 821	✓
B21	1447.9 to 1462.9	1495.9 to 1510.9	✓
B22*	3410 to 3490	3510 to 3590	✓
B23*	2000 to 2020	2180 to 2200	✓
B24	1626.5 to 1660.5	1525 to 1559	✓
B25	1850 to 1915	1930 to 1995	✓
B26	814 to 849	859 to 894	✓
B27*	807 to 824	852 to 869	✓
B28	703 to 748	758 to 803	✓
B29		717 to 728	✓
B30	2305 to 2315	2350 to 2360	✓
B31	452.5 to 457.5	462.5 to 467.5	*
B32		1452 to 1496	✓
B34		2010 to 2025	✓
B35		1850 to 1910	✓
B36		1930 to 1990	✓
B37		1910 to 1930	✓
B38		2570 to 2620	✓
B39		1880 to 1920	✓
B40		2300 to 2400	✓
B41		2496 to 2690	✓
B42		3400 to 3600	✓
B43		3600 to 3800	✓
B45		1447 to 1467	✓
B46		5150 to 5925	✓
B47		5855 to 5925	✓
B48		3550 to 3700	✓
B49		3550 to 3700	✓
B50		1432 to 1517	✓
B51		1427 to 1432	✓
B52		3300 to 3400	✓
B53		2483.5 to 2495	✓
B65	1920 to 2010	2110 to 2200	✓
B66	1710 to 1780	2110 to 2200	✓
B68	698 to 728	753 to 783	✓
B69		2570 to 2620	✓
B70	1695 to 1710	1995 to 2020	✓
B71	663 to 698	617 to 652	✓
B72	451 to 456	461 to 466	*
B73	450 to 455	460 to 465	*
B74	1427 to 1470	1475 to 1518	✓
B75		1432 to 1517	✓
B76		1427 to 1432	✓
B77		3300 to 4200	✓
B78		3300 to 3800	✓
B79		4400 to 5000	✓
B85	698 to 716	728 to 746	✓
B87	410 to 415	420 to 425	*
B88	412 to 417	422 to 427	*

### 3. Antenna Characteristics

#### 3.1 Return Loss

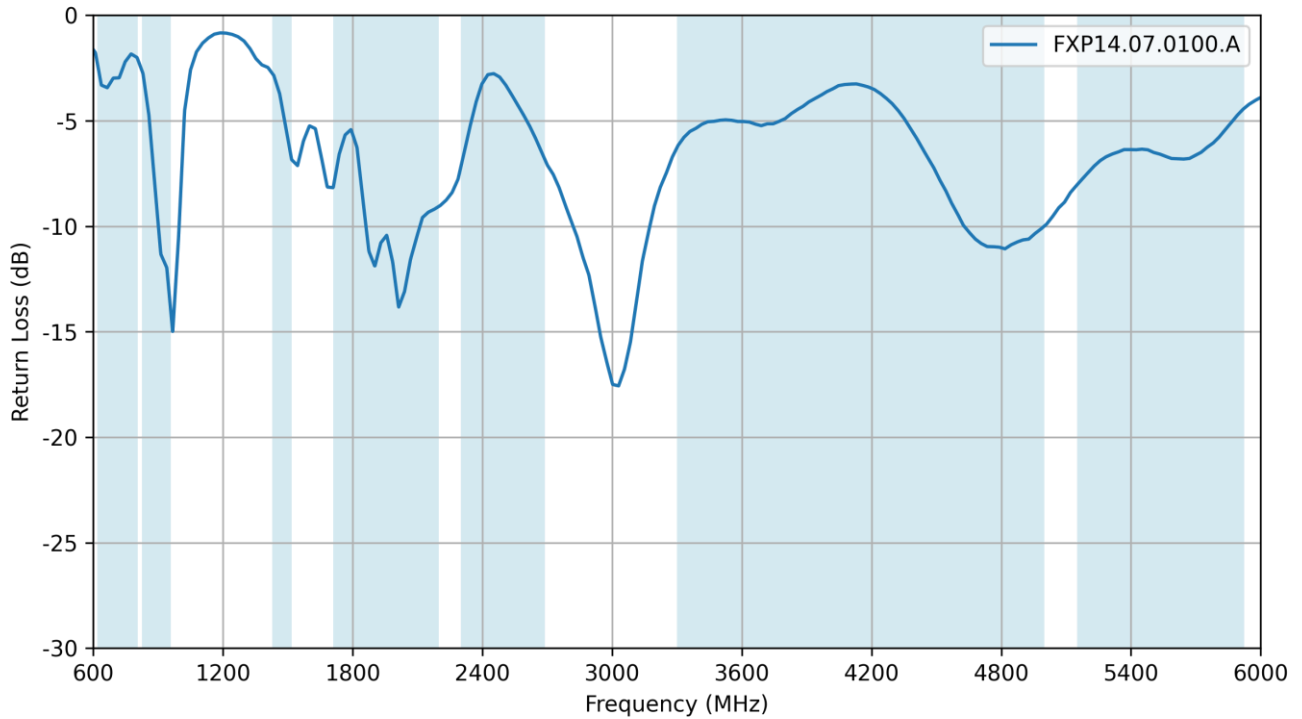

#### 3.2 VSWR

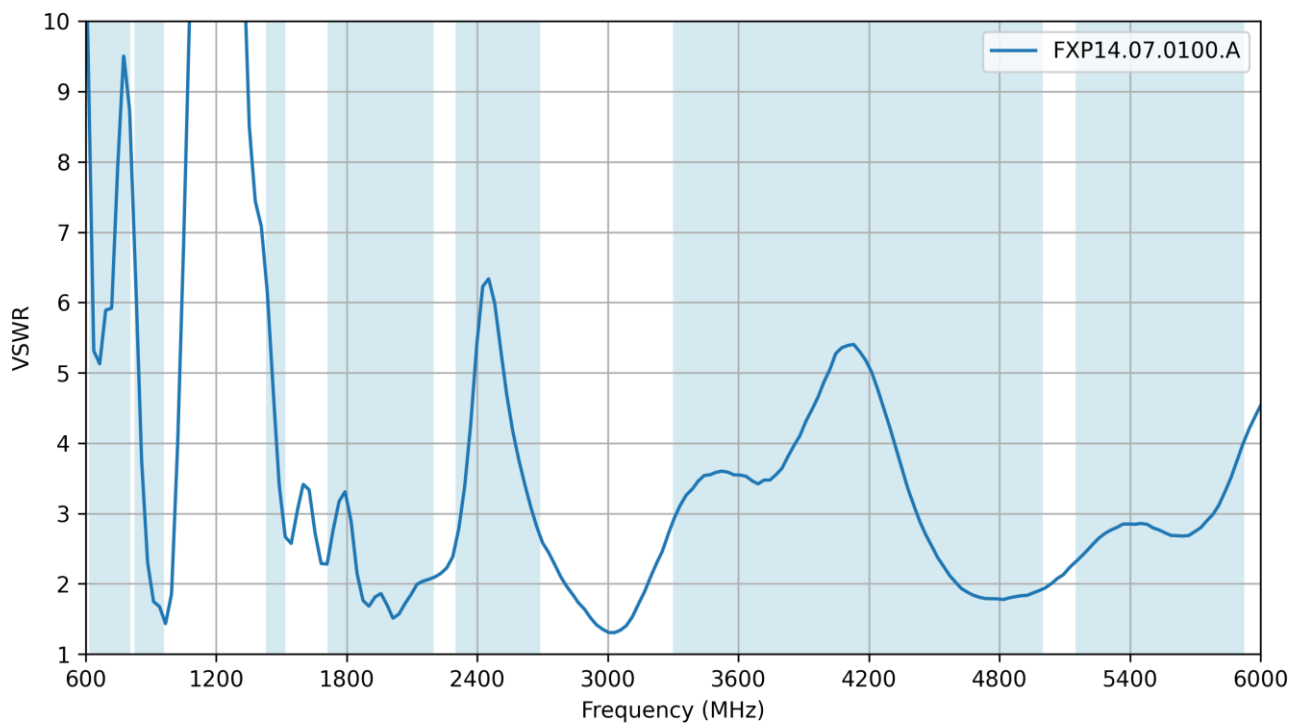

### 3.3 Efficiency

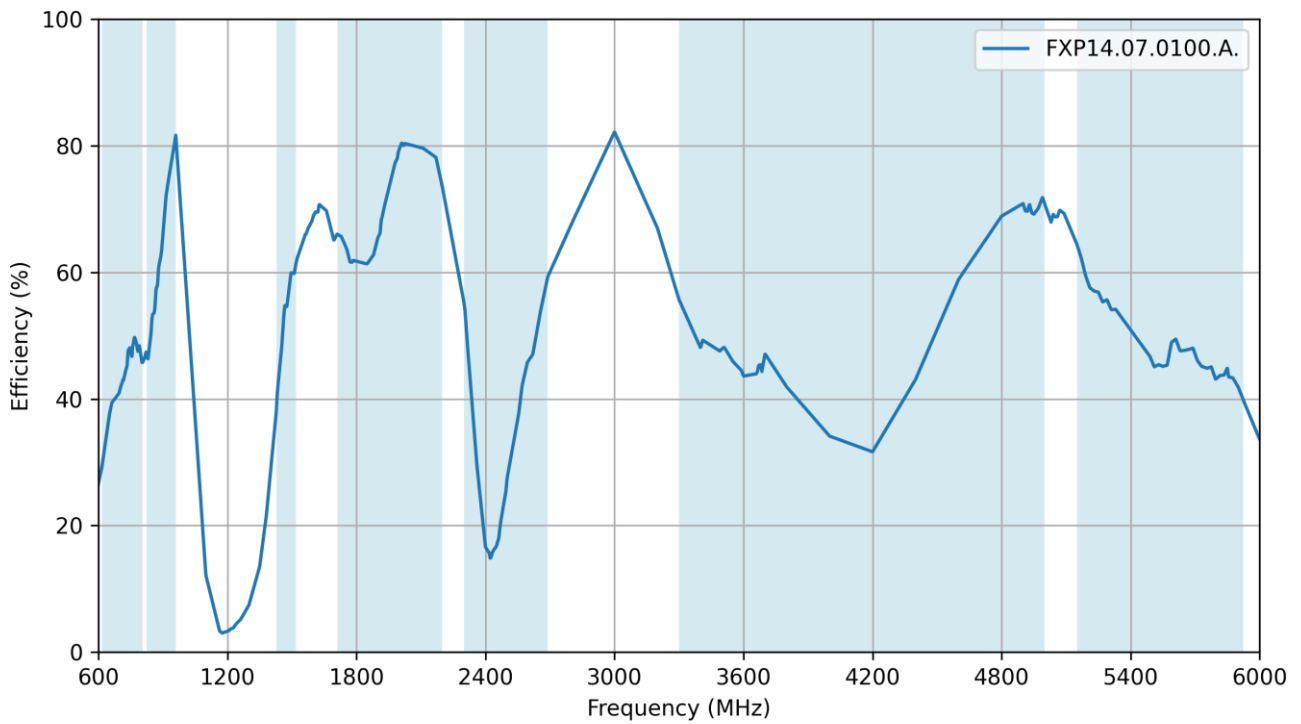

### 3.4 Average Gain

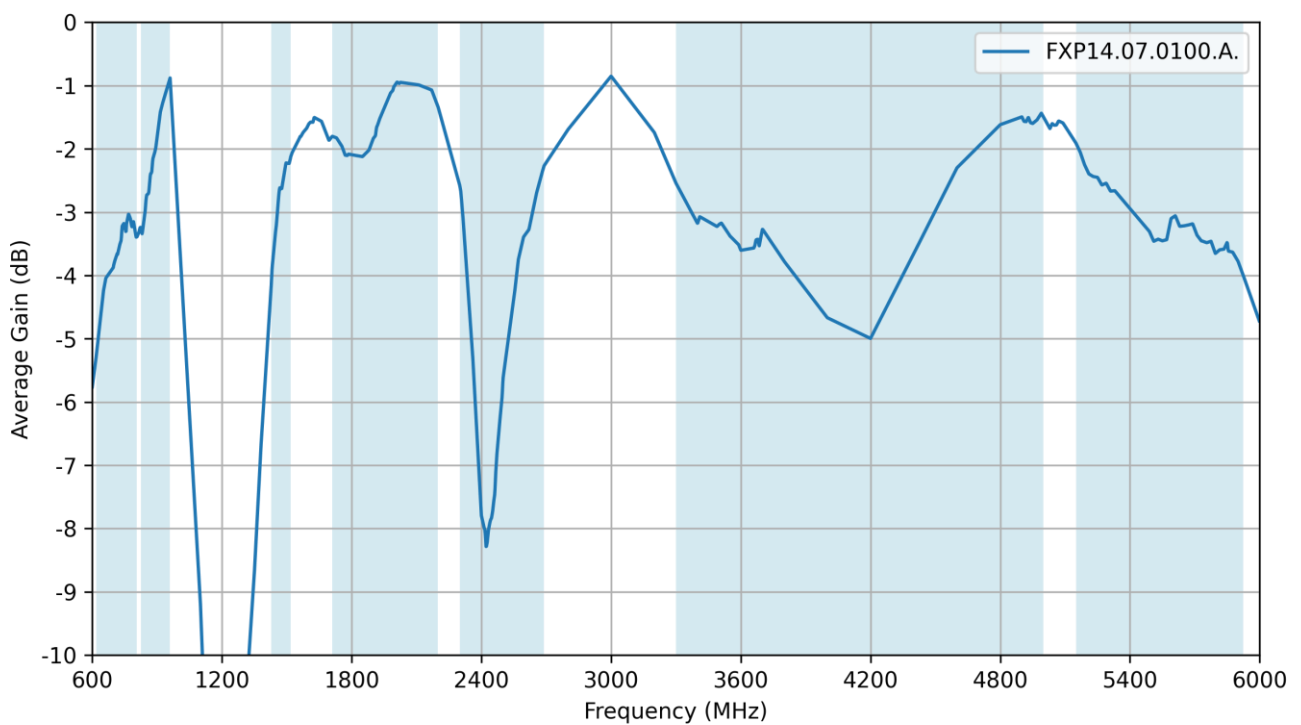

### 3.5 Peak Gain

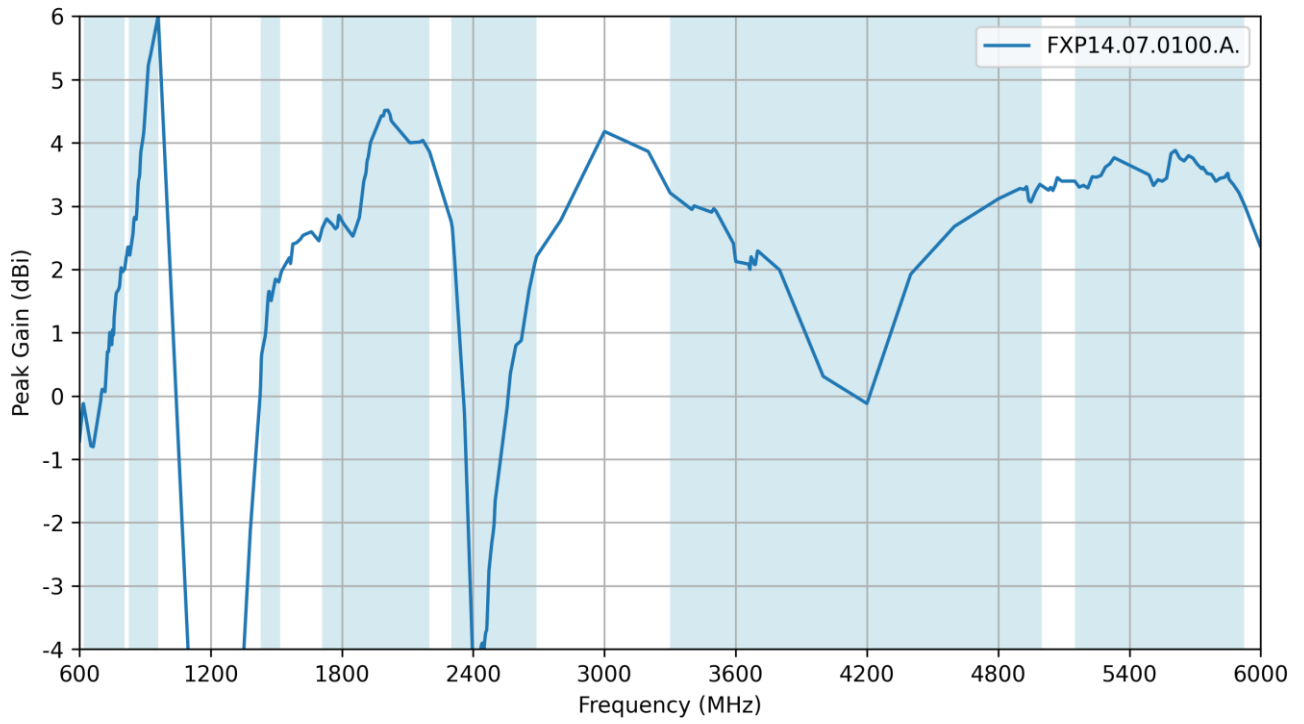

## 4. Radiation Patterns

### 4.1 Test Setup

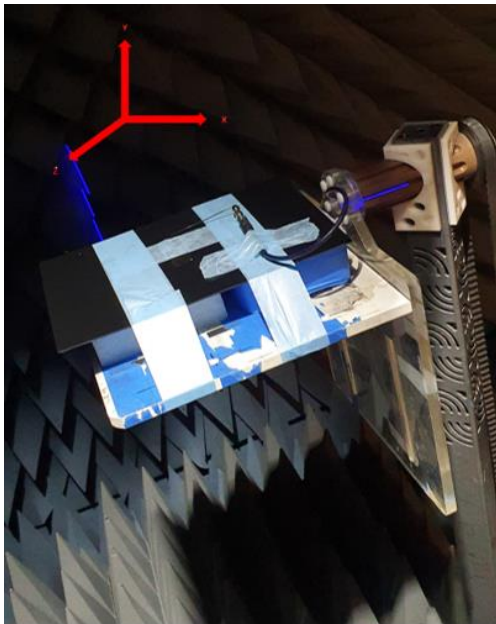
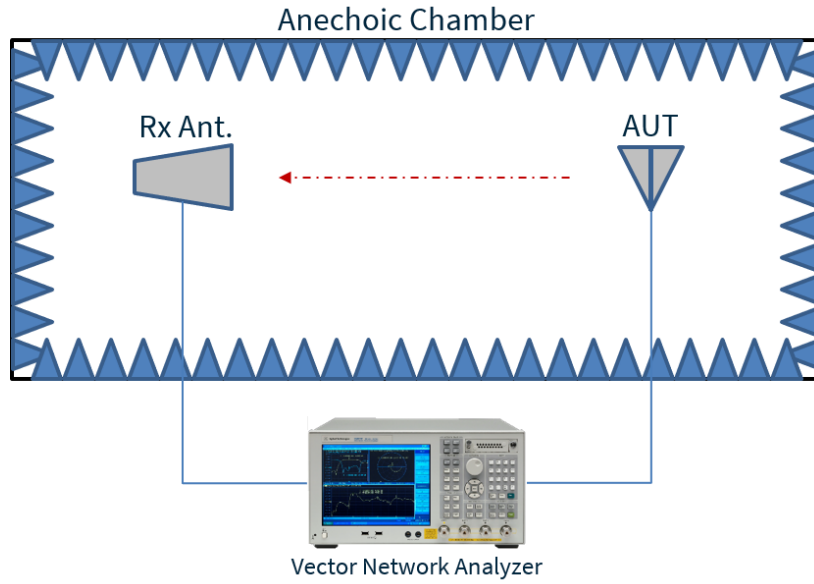

Chamber Setup

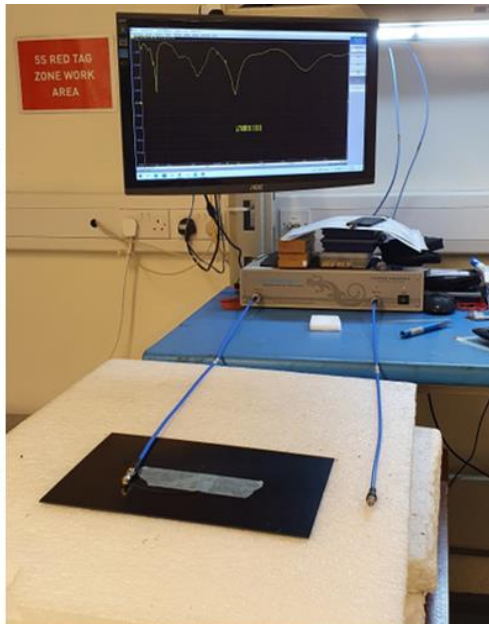

VNA Setup

4.2 FXP14.07.0100.A - Patterns at 650 MHz

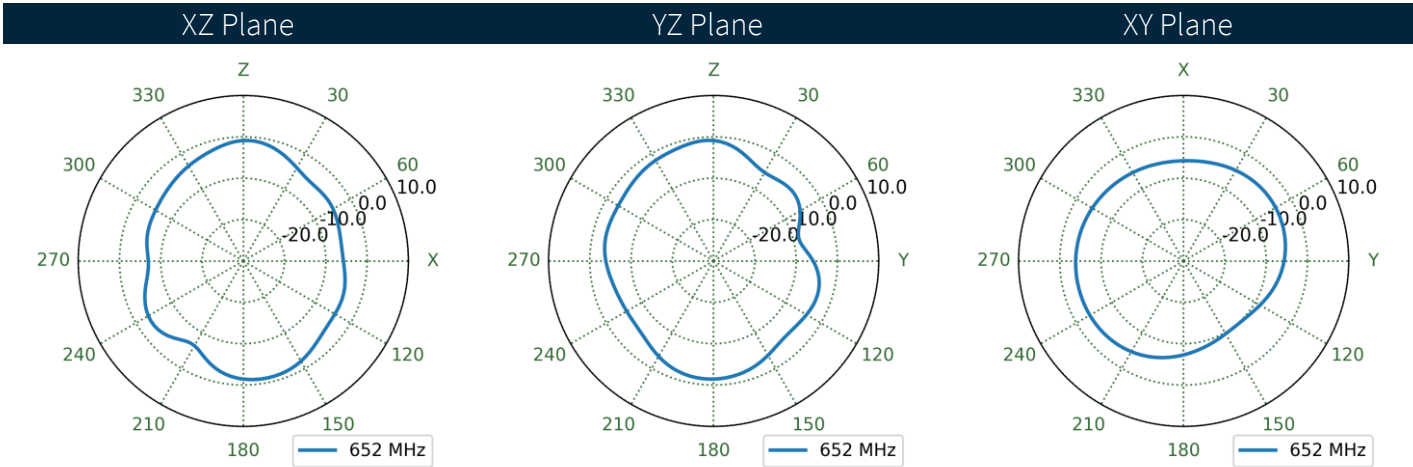
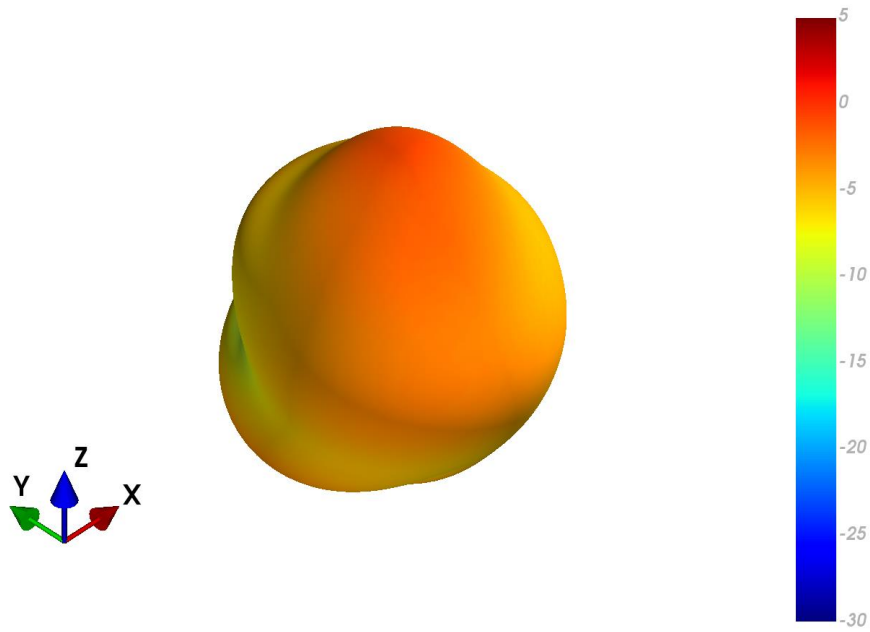

4.3 FXP14.07.0100.A - Patterns at 750 MHz

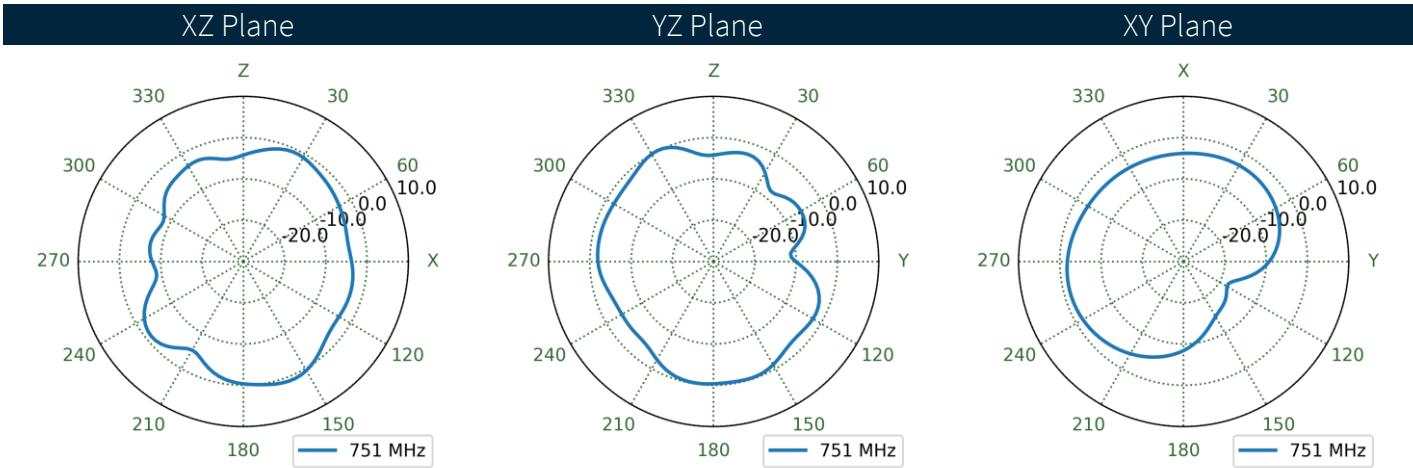
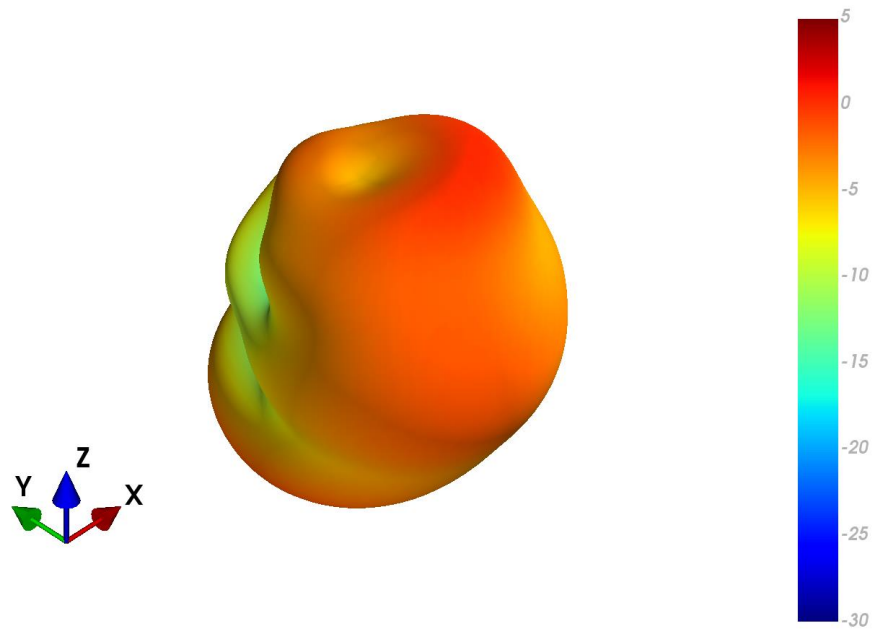

4.4 FXP14.07.0100.A - Patterns at 890 MHz

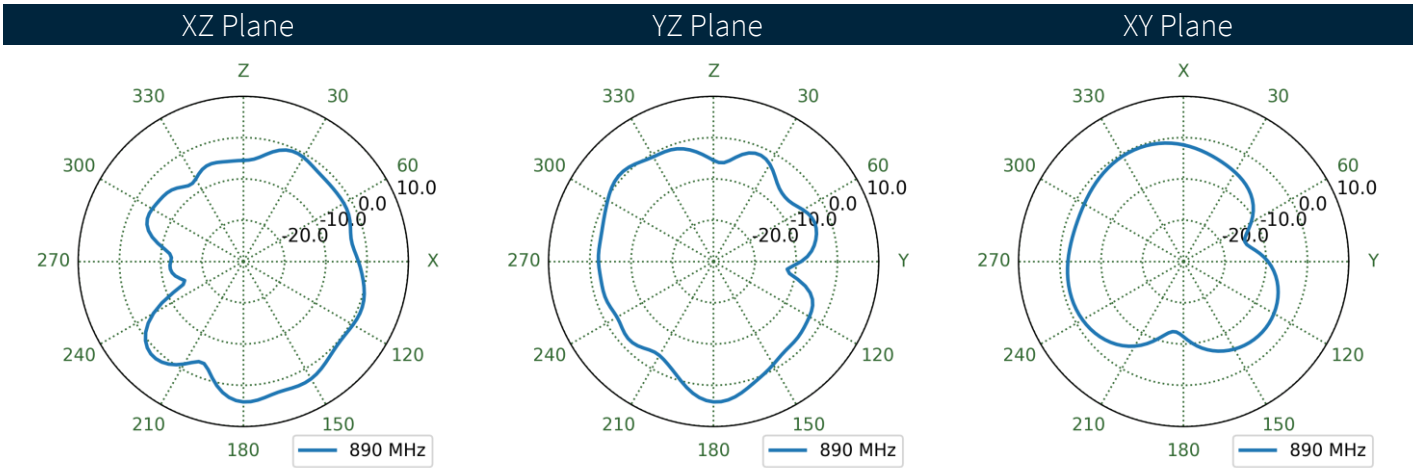
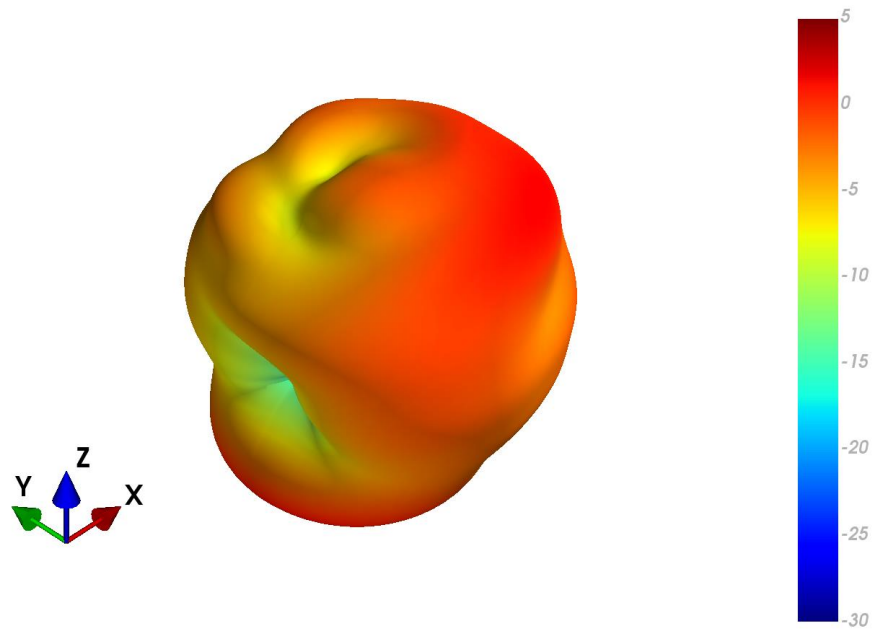

4.5 FXP14.07.0100.A - Patterns at 1475 MHz

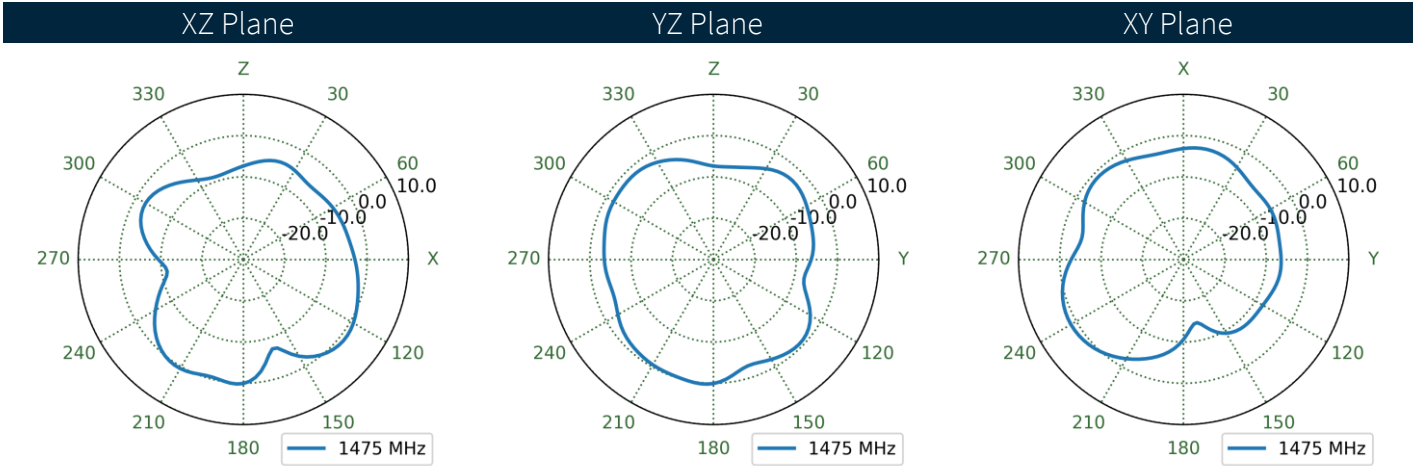
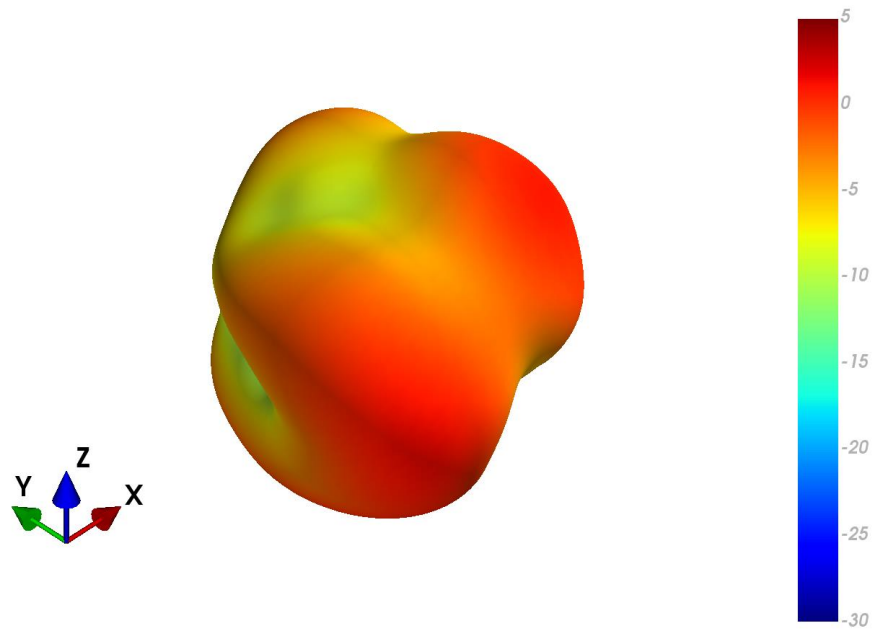

4.6 FXP14.07.0100.A - Patterns at 1950 MHz

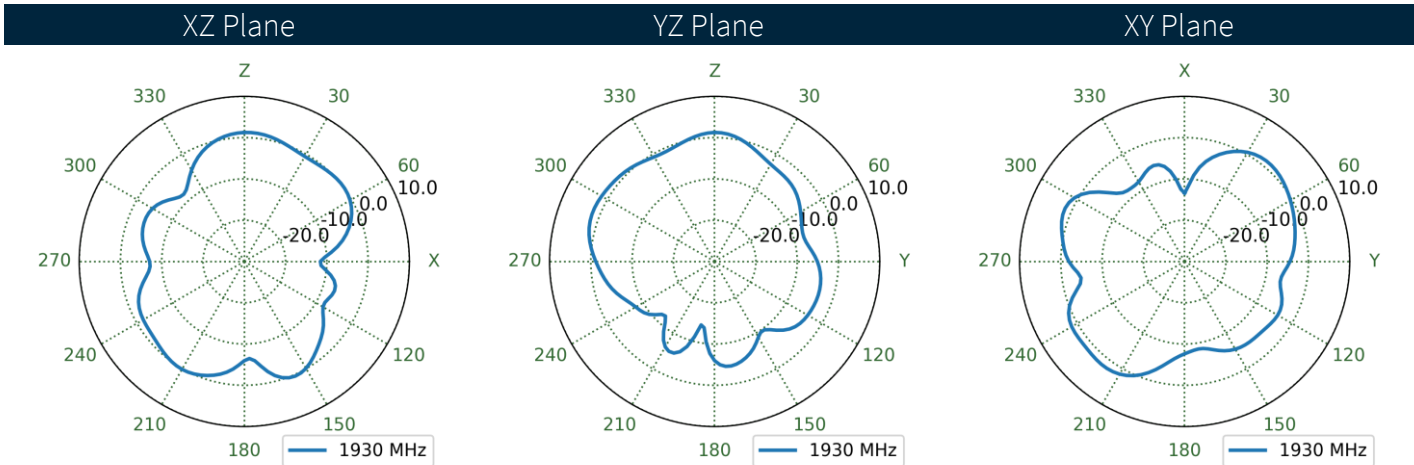
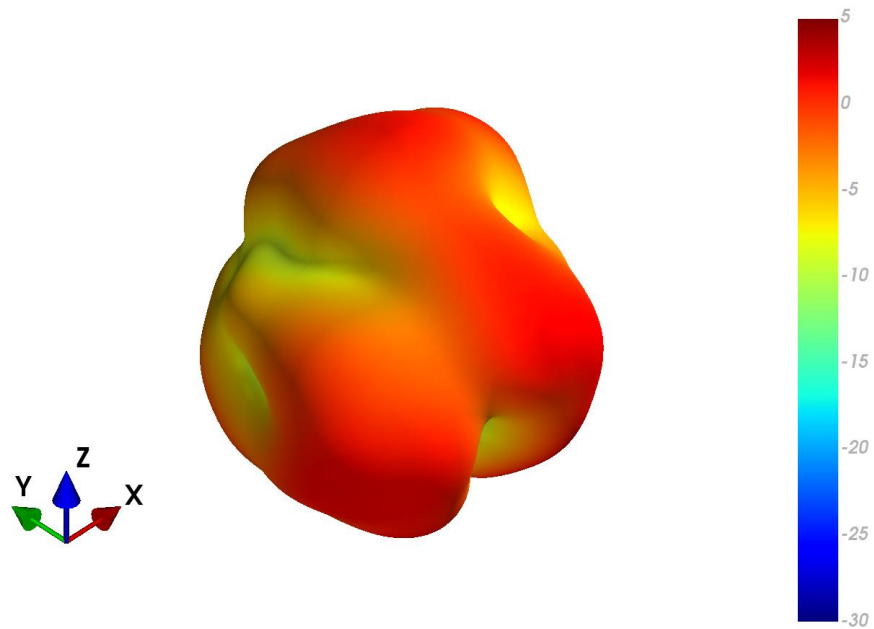

4.7 FXP14.07.0100.A - Patterns at 2500 MHz

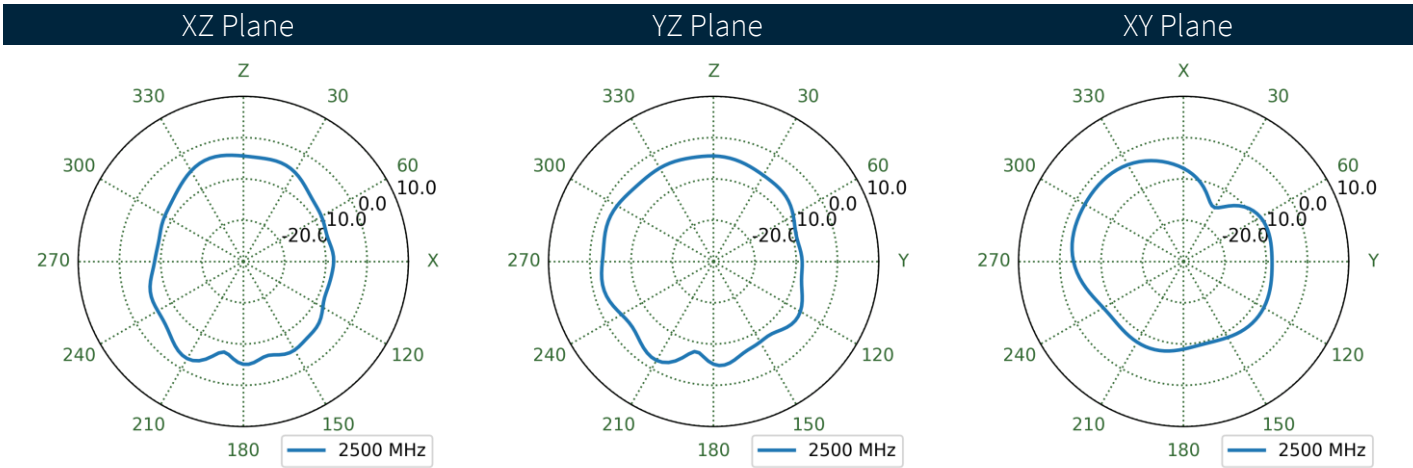
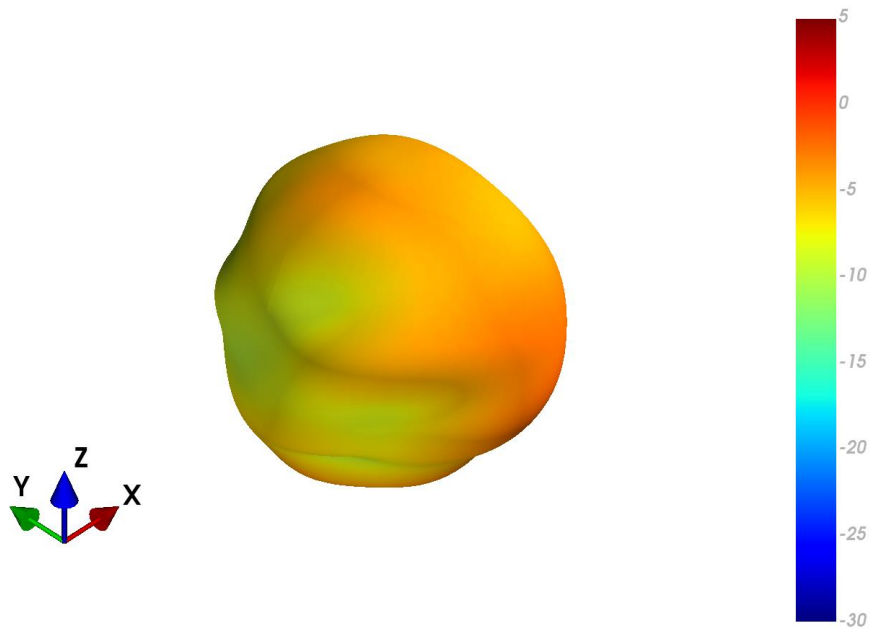

4.8 FXP14.07.0100.A - Patterns at 4150 MHz

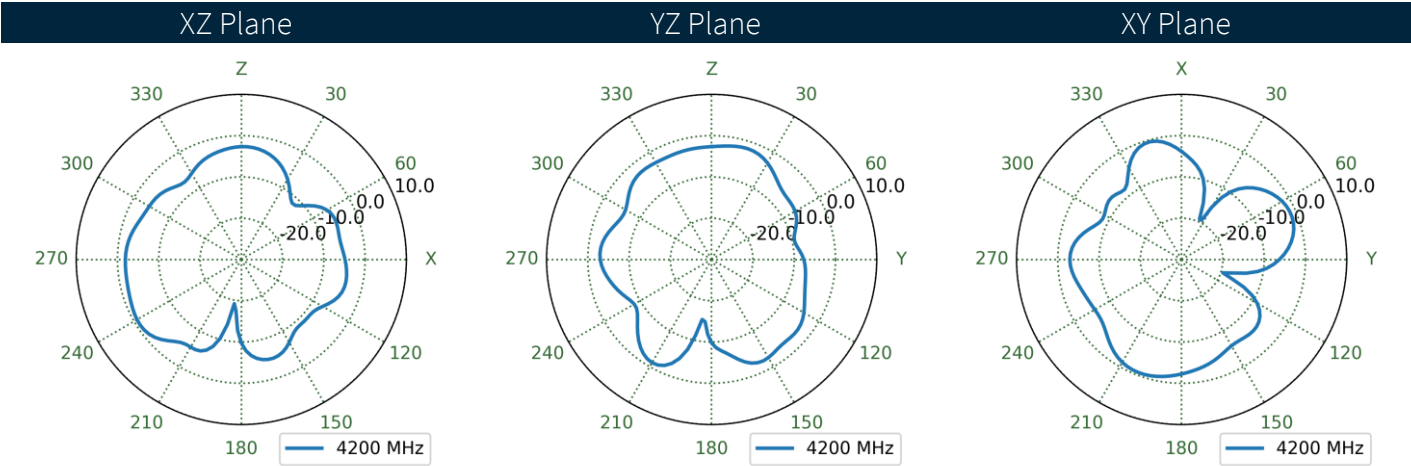
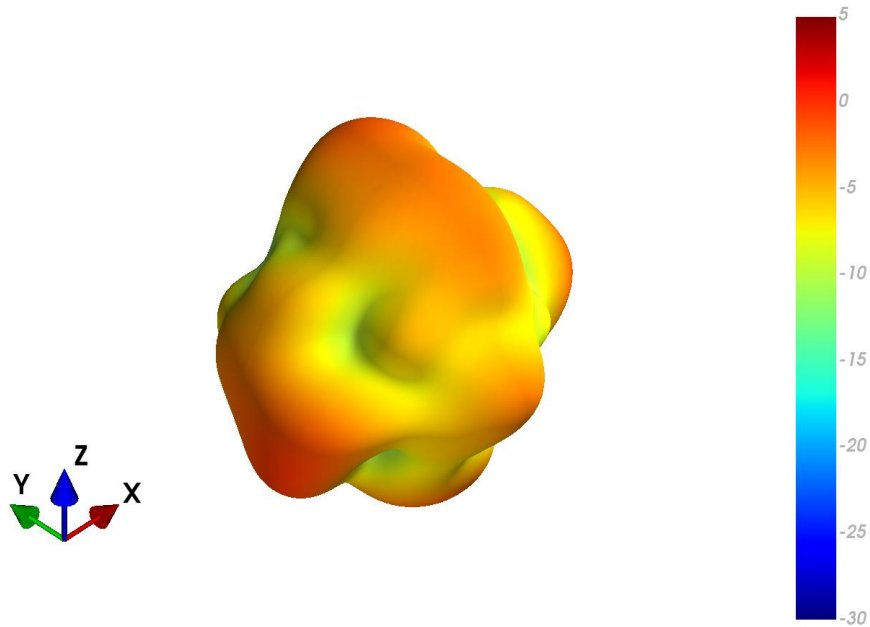

4.9 FXP14.07.0100.A - Patterns at 5550 MHz

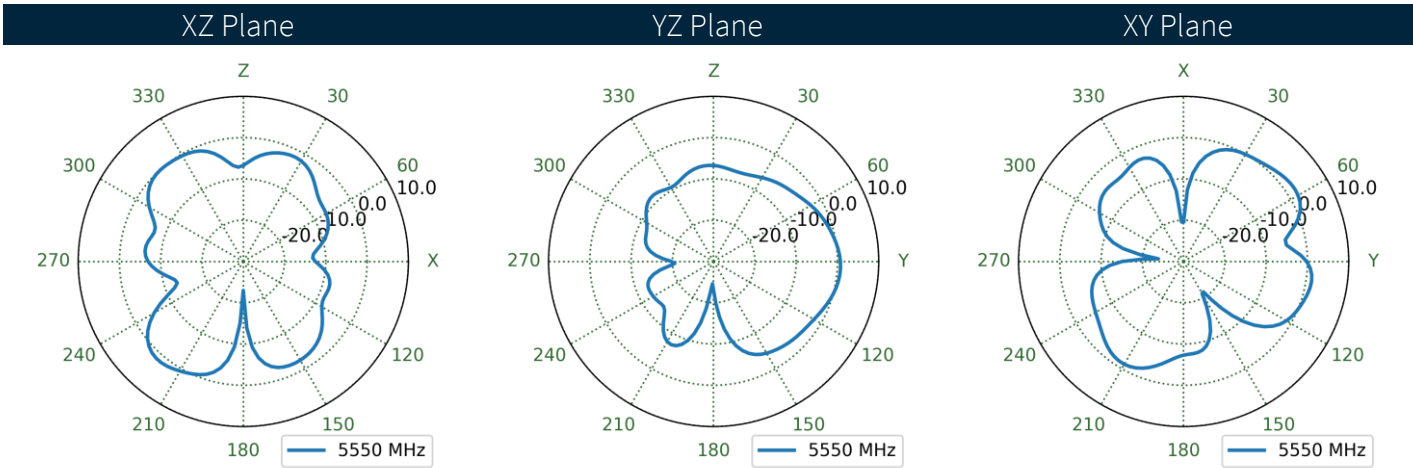
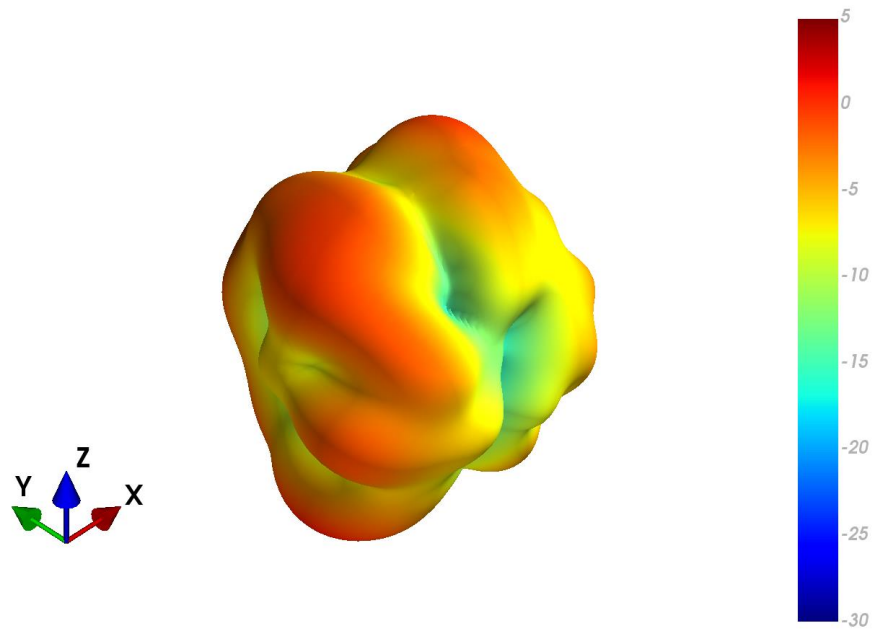

# 5. Mechanical Drawing

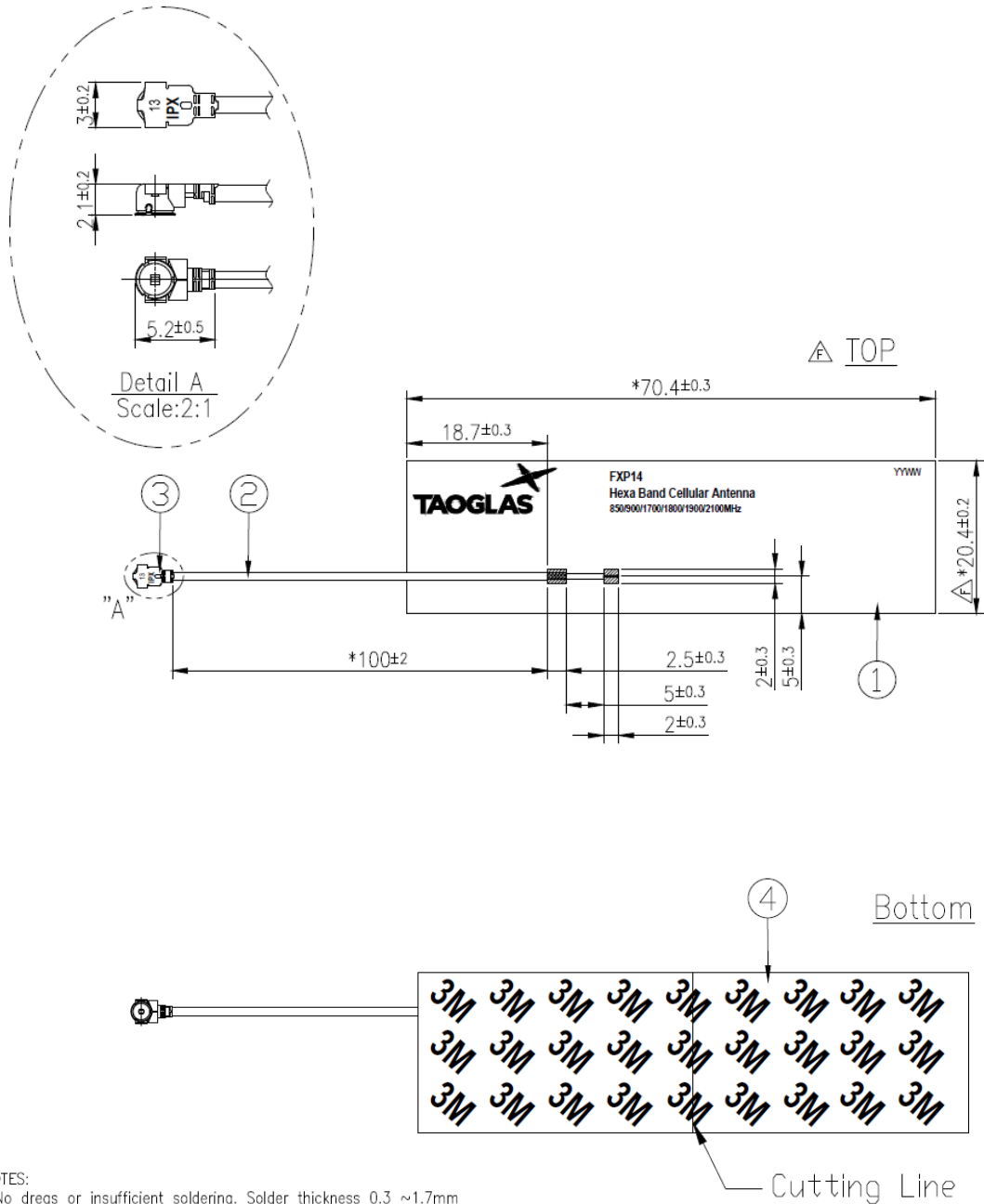

**NOTES:**

- 1.No dregs or insufficient soldering. Solder thickness 0.3 ~1.7mm
- 2.The solder must be smooth and full to the edges of the pad.  
The solder must not extend outside of the pad area.
- 3.The connector position has special orientation to the PCB as per drawing.
- 4.All material must be RoHS compliant.
- 5.Open/short QC, VSWR required.
- 6.Soldered area.
- 7."\*" Critical Dimensions.

	Name	P/N	Material	Finish	QTY
1	FXP14 FPCB	100113A000033A	Polymer 0.24t	Black	1
2	1.13 Coaxial Cable	300215C020000A	FEP	Black	1
3	IPEX MHF1(20278-112R-13)	204111G000000A	Brass	Au Plated	1
4	Double-Sided Adhesive	100113A000033A	3M 467	Brown Liner	1

## 6. Packaging

100pcs FXP14.07.0100A per PE Bag  
 Dimensions - 300\*100mm  
 Weight - 150g

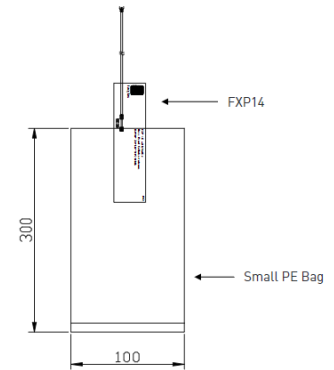

Changelog for the datasheet

**SPE-12-8-050 – FXP14.07.0100A**

**Revision: G**

Date:	2023-01-18
Changes:	Full datasheet update
Changes Made by:	Gary West

**Previous Revisions**

**Revision: F**

Date:	2022-06-15
Changes:	Retest data, verify & updated
Changes Made by:	Evan Murphy

**Revision: A (Original First Release)**

Date:	2012-04-30
Notes:	
Author:	Aine Doyle

**Revision: E**

Date:	2019-11-14
Changes:	Updated Images
Changes Made by:	Russell Meyler

**Revision: D**

Date:	2019-07-12
Changes:	Updated EDW
Changes Made by:	Jack Conroy

**Revision: C**

Date:	2014-08-12
Changes:	Amended IPEX
Changes Made by:	Aine Doyle

**Revision: B**

Date:	2013-09-17
Changes:	Updated EDW
Changes Made by:	Aine Doyle



[www.taoglas.com](http://www.taoglas.com)



## Looking for pricing, stock, or lifecycle information?

Click below to explore more details on WIN SOURCE:

 [View FXP14.07.0100A on WIN SOURCE](#)

 [Taoglas Limited](#) Information

## Optimize Your Supply Chain with WIN SOURCE Solutions

-  Global Sourcing Solution
-  Obsolete Management
-  Cost Control Management
-  Shortage Management
-  Alternative Solution
-  Excess Inventory Management