



**THE DATASHEET OF
GW.11.A153**



Specification

Part No. : GW.11.A153
Product Name : 2.4GHz 2.3dBi Terminal Mount Dipole
Antenna
Description : Connector Mount Terminal Antenna
90 Degree Hinged Connector
Black TPE Housing
Straight Length: 84mm
Connector : RP-SMA(M)
ROHS Compliant

[.



1. Introduction

The GW.11 2.4 GHz dipole RP-SMA terminal mount antenna is ideal for 2.4GHz wireless applications such as Bluetooth[®] and Wireless LAN. At only 84mm in length omni-directional 2.3dBi gain across all bands ensures constant reception and transmission. The antenna structure is designed for robust handling and the housing is made with TPE giving superior environmental reliability and a quality finish. The antenna can be rotated 90 degrees on the base hinge for ease of placement.

Many module manufacturers specify peak gain limits for any antennas that are to be connected to that module. Those peak gain limits are based on free-space conditions. In practice, the peak gain of an antenna tested in free-space can degrade by at least 1 or 2dBi when put inside a device. So ideally you should go for a slightly higher peak gain antenna than mentioned on the module specification to compensate for this effect, giving you better performance. Upon testing of any of our antennas with your device and a selection of appropriate layout, integration technique, or cable, Taoglas can make sure any of our antennas' peak gain will be below the peak gain limits. Taoglas can then issue a specification and/or report for the selected antenna in your device that will clearly show it complying with the peak gain limits, so you can be assured you are meeting regulatory requirements for that module.

For example, a module manufacturer may state that the antenna must have less than 2dBi peak gain, but you don't need to select an embedded antenna that has a peak gain of less than 2dBi in free-space. This will give you a less optimized solution. It is better to go for a slightly higher free-space peak gain of 3dBi or more if available. Once that antenna gets integrated into your device, performance will degrade below this 2dBi peak gain due to the effects of GND plane, surrounding components, and device housing. If you want to be

absolutely sure, contact Taoglas and we will test. Choosing a Taoglas antenna with a higher peak gain than what is specified by the module manufacturer and enlisting our help will ensure you are getting the best performance possible without exceeding the peak gain limits.

It is better not to select an embedded antenna with very low free-space peak gain (<2dBi) directly, as this antenna would have worse performance in your device, and lead to compromised performance compared to using a Taoglas antenna. Connector mount is fully customizable. The GW.11 is also available in white.

2. Specification Table

Parameter	GSM Band			
	Bluetooth 2401-2480	Wi-Fi 2412-2462	ZigBee 2410-2480	2.4GHz ISM 2400-2483.5
Peak Gain (dBi)*	2.3			
Average Gain (dB)*	-0.88			
Efficiency (%)*	80%			
Return Loss (dB)*	- 10 dB Maximum			
Radiation	Omni-directional			
Polarization	Linear Vertical			
Power Handling	1W			
Impedance	50 Ω			
	Mechanical			
Cable	RG-178 Coaxial Cable			
Antenna Cover	TPE			
Antenna Base	PC & PBT			
Color	Black			
Connector	RP-SMA(M)			
	Environmental			
Operation Temperature	-40°C ~ + 85°C			
Storage Temperature	-40°C ~ + 85°C			

*The antenna was measured in free space

3. Antenna Characteristics

3.1 Return Loss

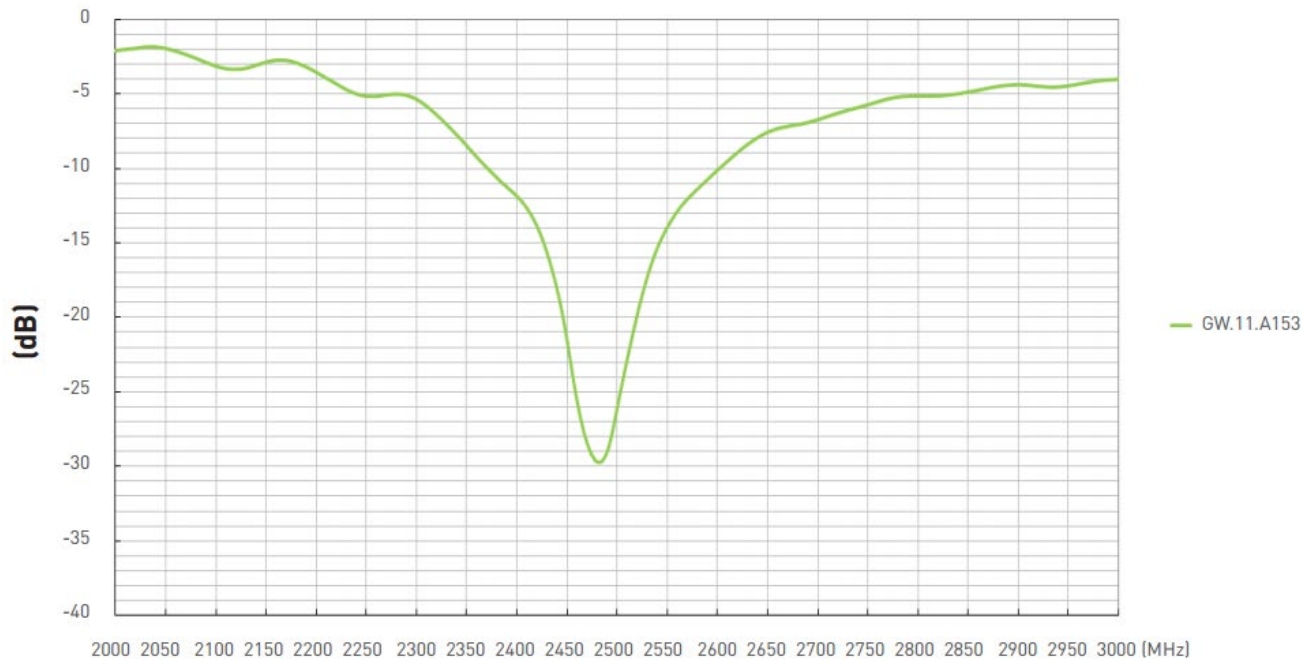

3.2 Peak Gain

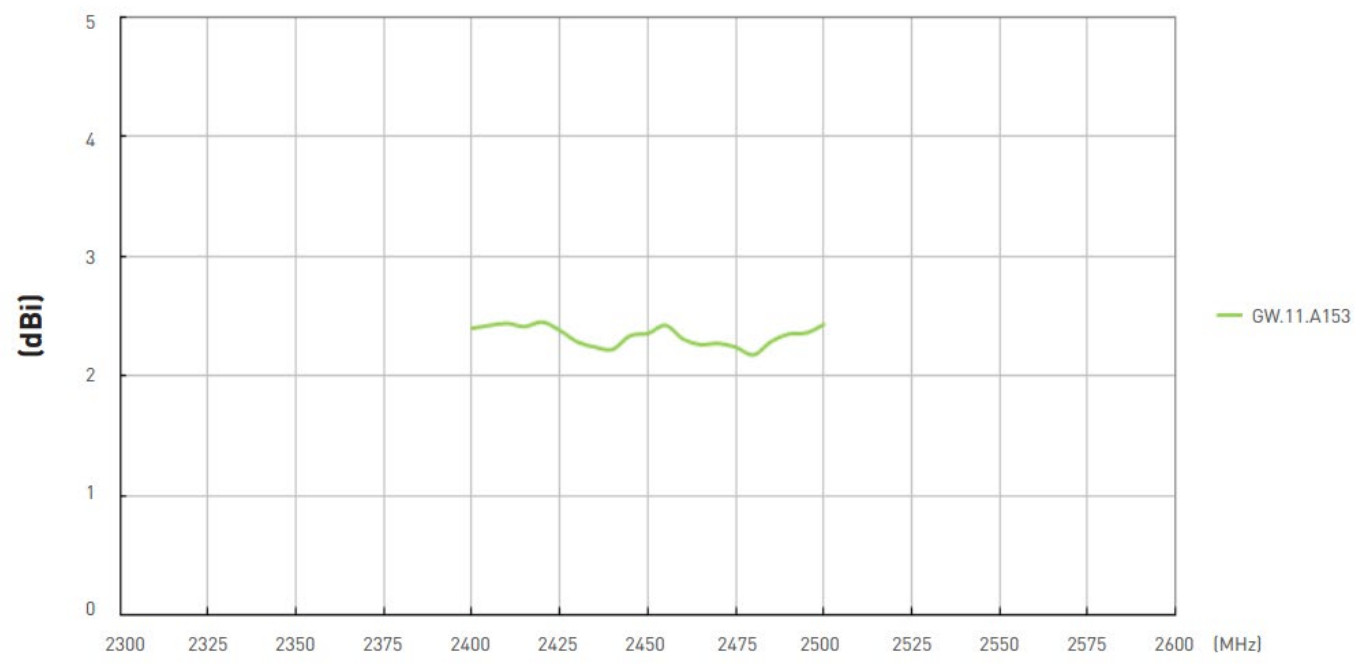

3.3 Average Gain

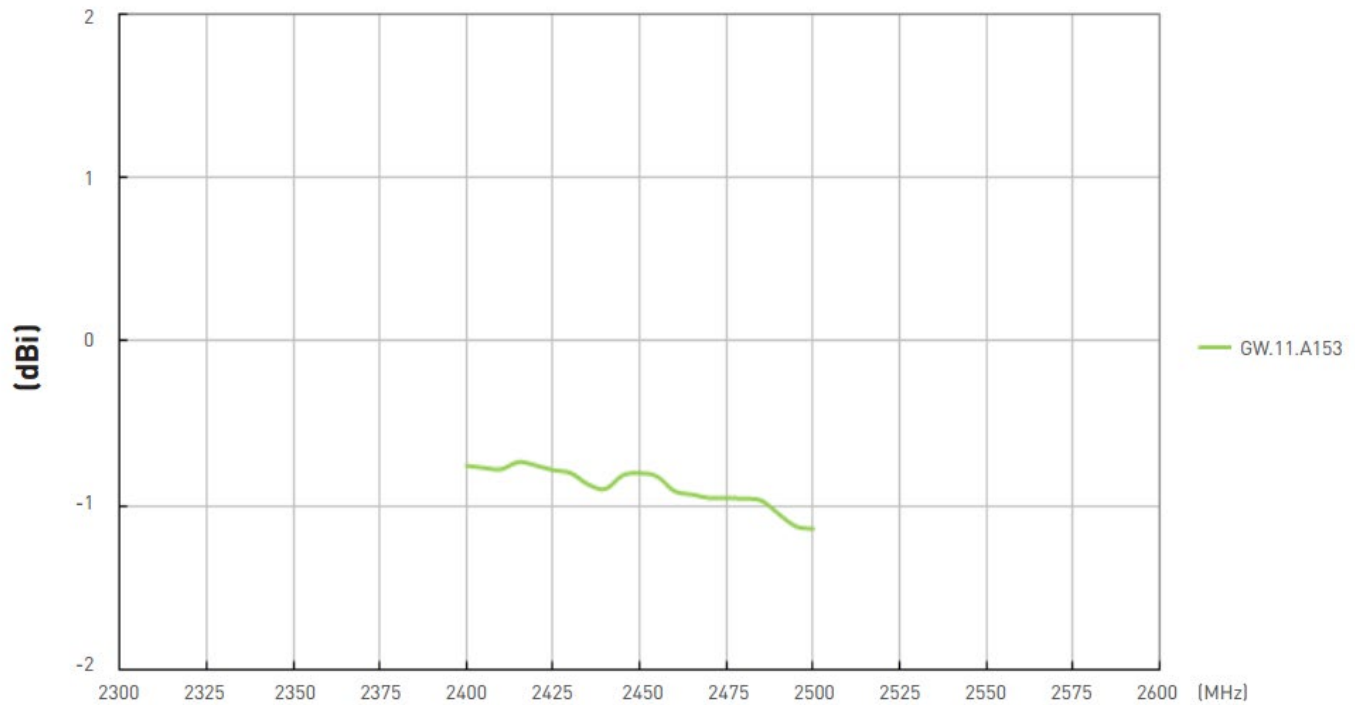

3.4 Efficiency

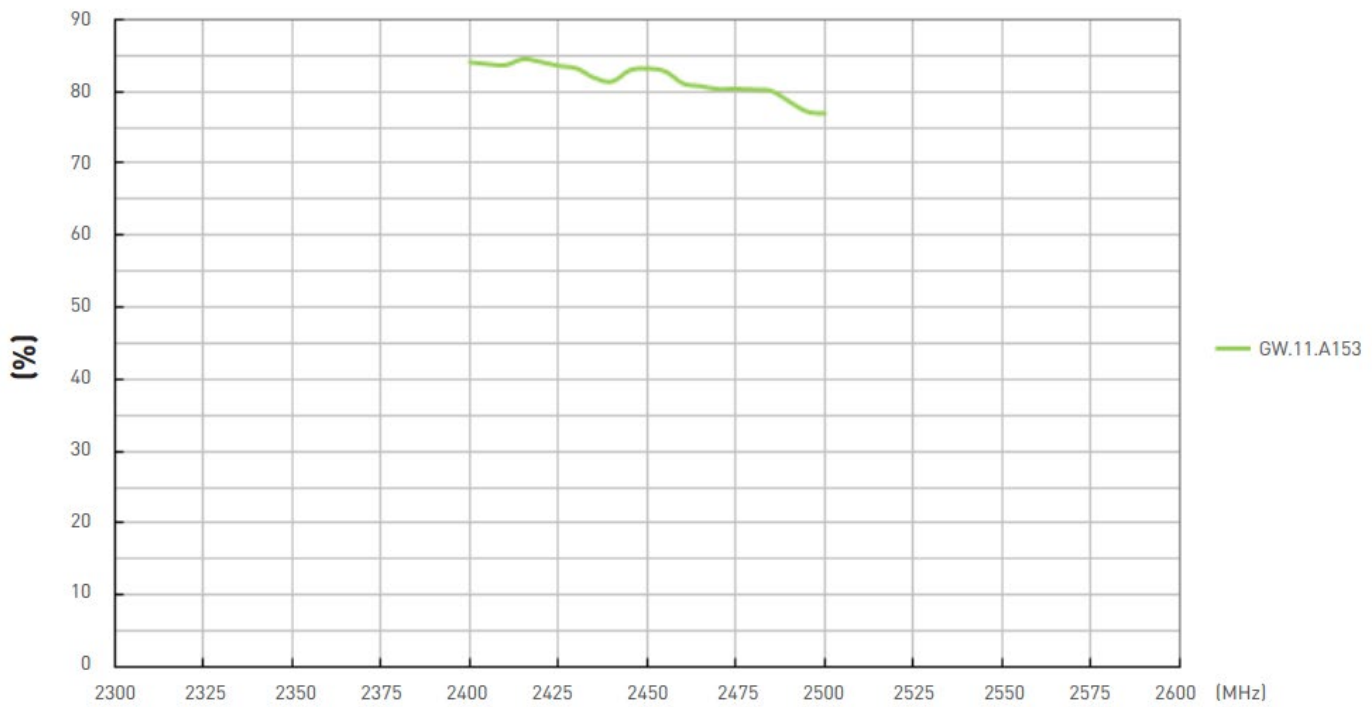

4. Radiation Patterns

The antenna radiation pattern was measured in ETS Anechoic Chamber.
The testing setup is as below.
The antenna was measured in free space.

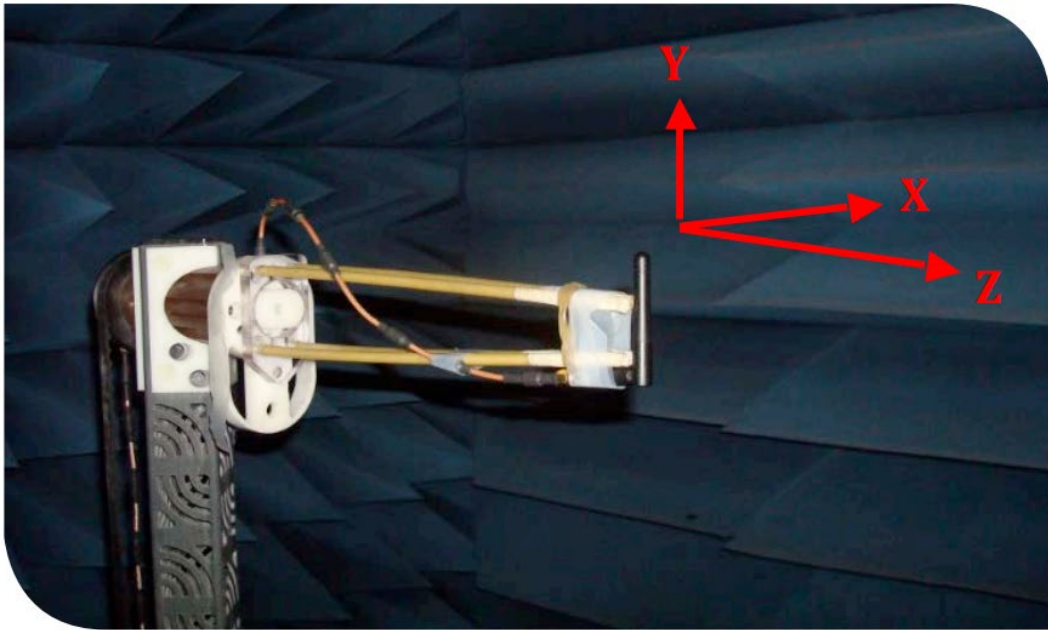

XY Plane

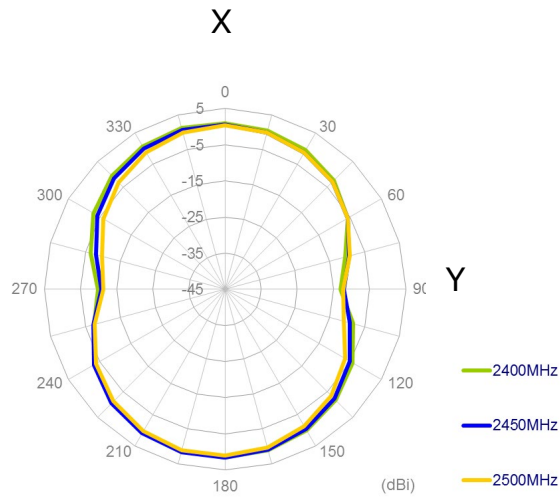

XZ Plane

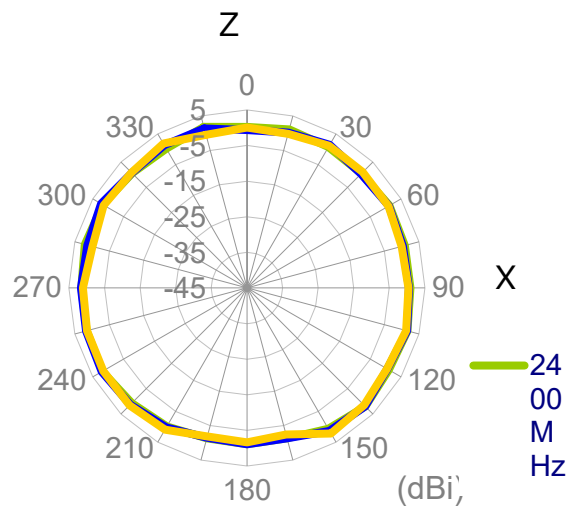

YZ Plane

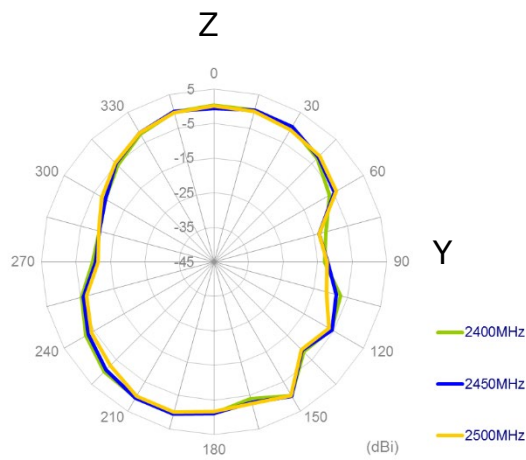

5. Drawing

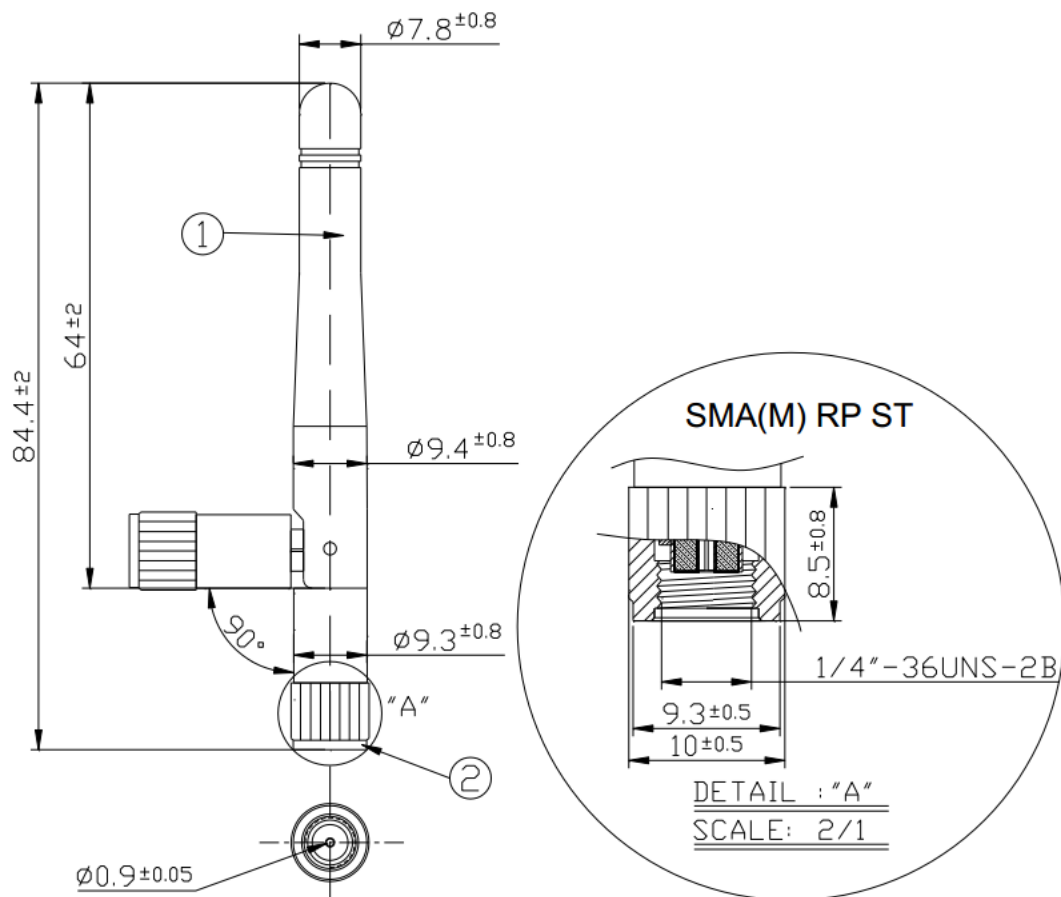

	Name	Material	Finish	QTY
1	Antenna Housing	TPU	Black	1
2	SMA(M) RP	PBT+Brass	Black	1

6. Application Note

6.1 The GW.11 antenna measurement setup (40mm*60mm PCB board)

On the short side

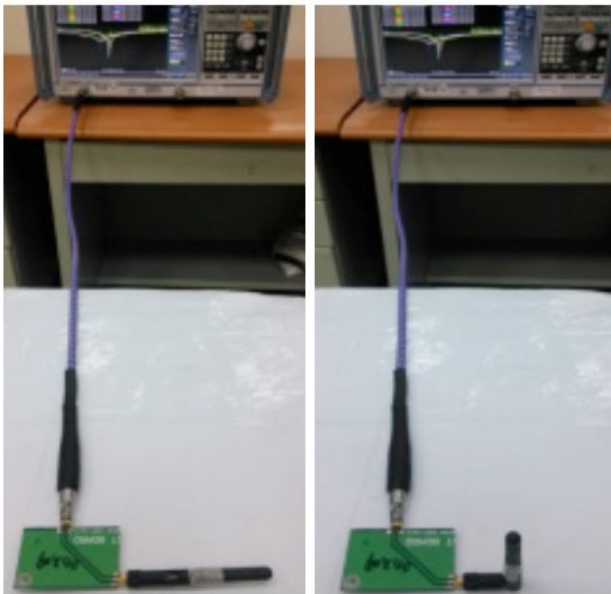

Antenna straight

Antenna R/A

On the long side

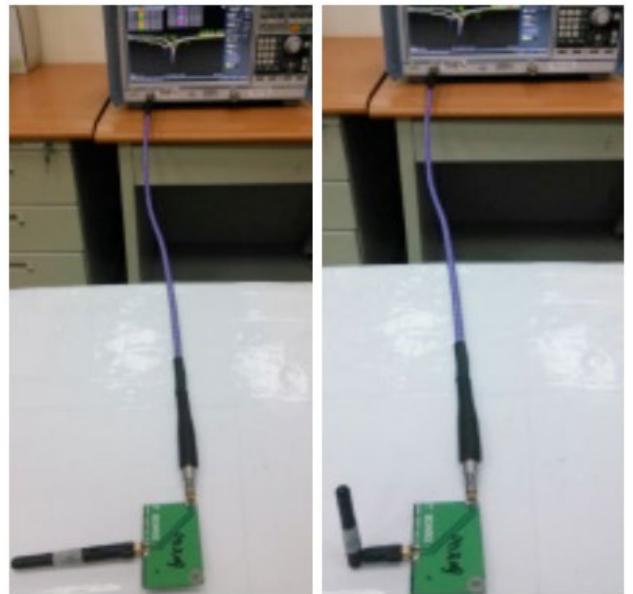

Antenna straight

Antenna R/A

On the 30cmx30cm ground plane

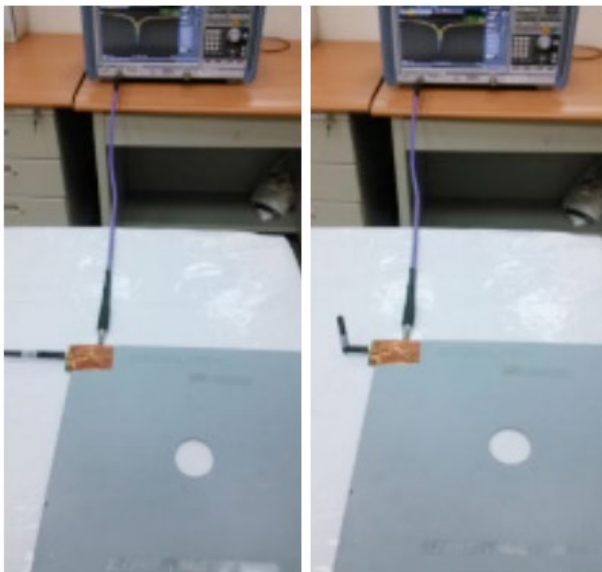

Antenna straight

Antenna R/A

On the 50cmx50cm ground

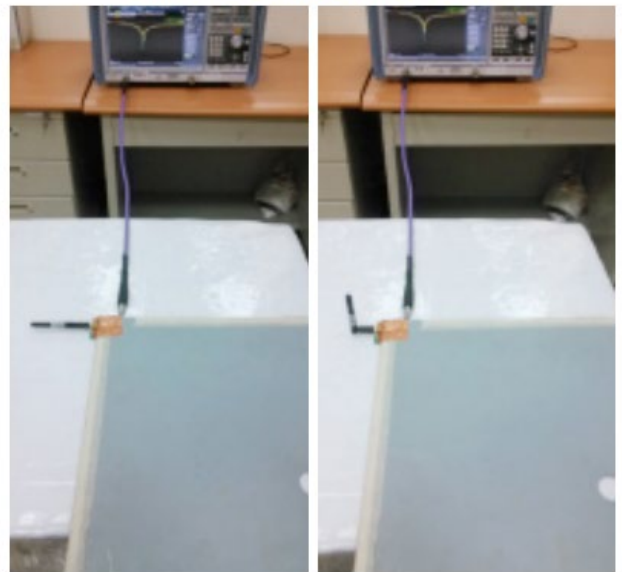

Antenna straight

Antenna R/A

6.2 Return Loss when antenna setup on different conditions.

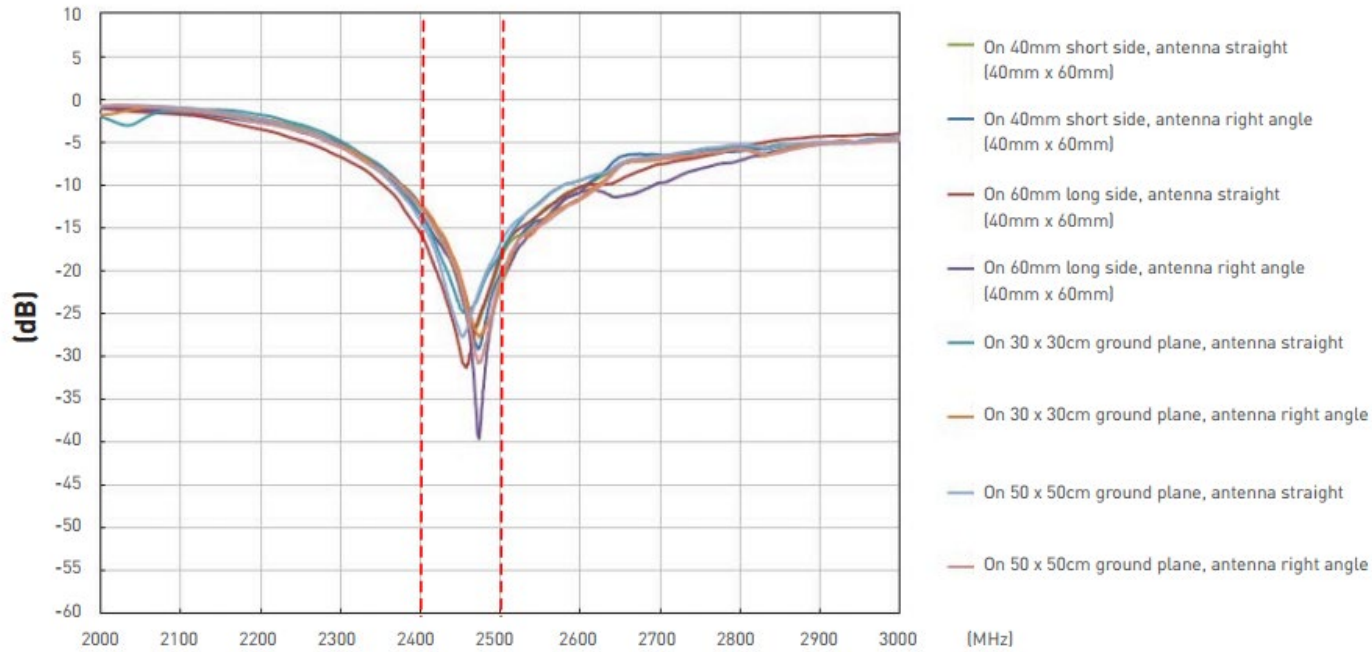

6.3 The GW.11 antenna measurement setup (40mmX100mm PCB board)



6.4 Return Loss when antenna setup on different conditions.

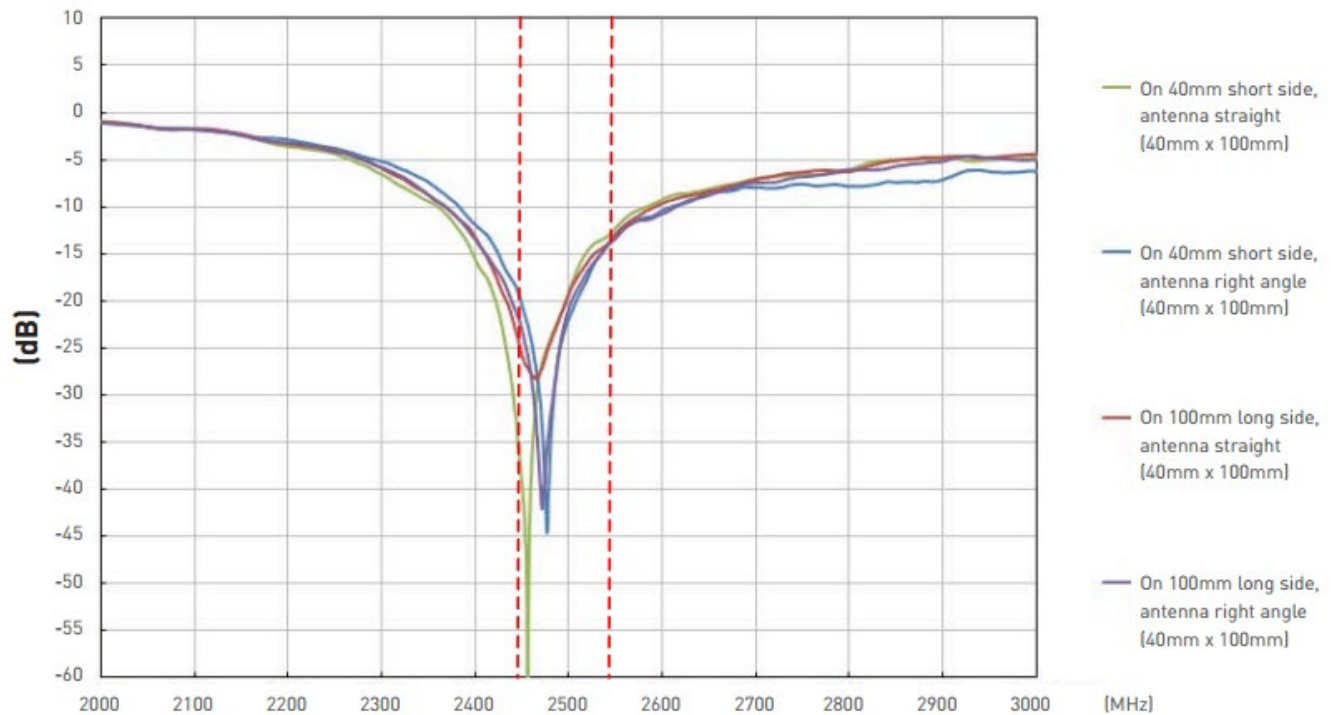

6.5 The GW.11 antenna measurement setup (90mmX150mm PCB board)



6.6 Return Loss when antenna setup on different conditions.

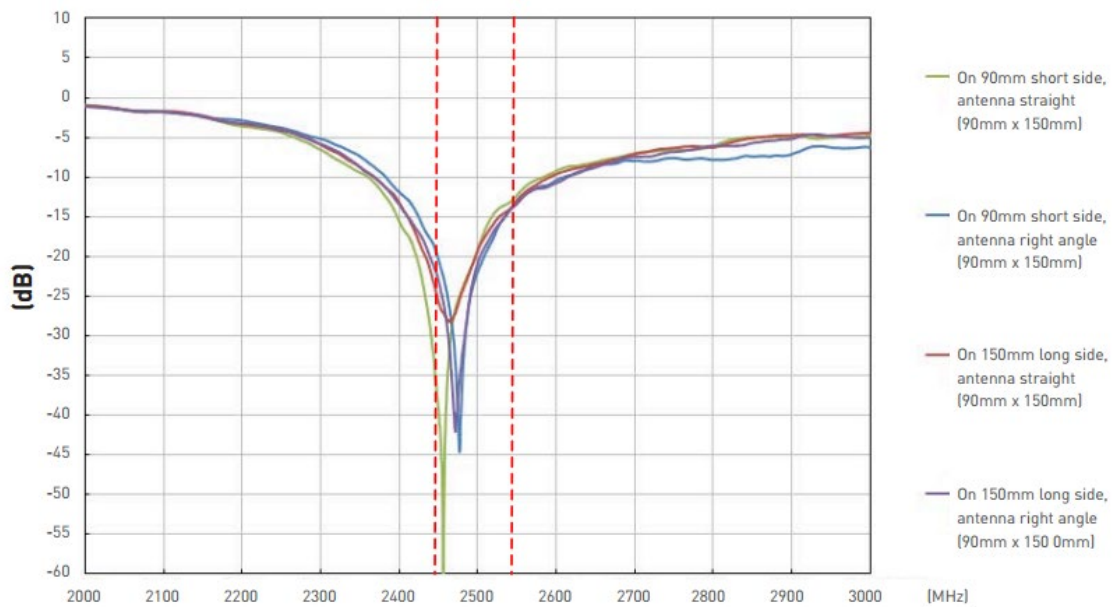



Taoglas makes no warranties based on the accuracy or completeness of the contents of this document and reserves the right to make changes to specifications and product descriptions at any time without notice. Taoglas reserves all rights to this document and the information contained herein.

Reproduction, use or disclosure to third parties without express permission is strictly prohibited.

© Taoglas

Looking for pricing, stock, or lifecycle information?

Click below to explore more details on WIN SOURCE:

 [View GW.11.A153 on WIN SOURCE](#)

 [Taoglas Limited](#) Information

Optimize Your Supply Chain with WIN SOURCE Solutions

-  Global Sourcing Solution
-  Obsolete Management
-  Cost Control Management
-  Shortage Management
-  Alternative Solution
-  Excess Inventory Management