



# THE DATASHEET OF HDBLS106G



## 1A, 50V - 1000V High Efficient Bridge Rectifier

### FEATURES

- AEC-Q101 qualified available
- Ideal for printed circuit board
- Reliable low cost construction utilizing molded plastic technique
- High surge current capability
- UL Recognized File # E-326854
- Moisture sensitivity level: level 1, per J-STD-020
- RoHS Compliant
- Halogen-free according to IEC 61249-2-21

### APPLICATIONS

- Switching mode power supply (SMPS)
- Adapters
- Lighting application

### MECHANICAL DATA

- Case: DBLS
- Molding compound meets UL 94V-0 flammability rating
- Terminal: Matte tin plated leads, solderable per J-STD-002
- Meet JESD 201 class 2 whisker test
- Polarity: As marked
- Weight: 0.360g (approximately)

KEY PARAMETERS		
PARAMETER	VALUE	UNIT
$I_F$	1	A
$V_{RRM}$	50 - 1000	V
$I_{FSM}$	50	A
$T_{J\ MAX}$	150	°C
Package	DBLS	
Configuration	Quad	

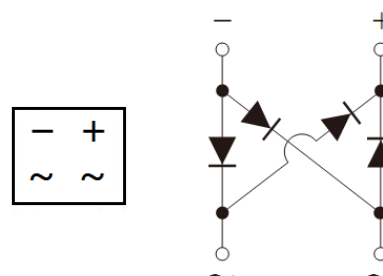
**DBLS**

### ABSOLUTE MAXIMUM RATINGS ( $T_A = 25^\circ\text{C}$ unless otherwise noted)

PARAMETER	SYMBOL	HDBLS	HDBLS	HDBLS	HDBLS	HDBLS	HDBLS	HDBLS	UNIT
		101G	102G	103G	104G	105G	106G	107G	
Marking code on the device		HDBLS 101G	HDBLS 102G	HDBLS 103G	HDBLS 104G	HDBLS 105G	HDBLS 106G	HDBLS 107G	
Repetitive peak reverse voltage	$V_{RRM}$	50	100	200	400	600	800	1000	V
Reverse voltage, total rms value	$V_{R(RMS)}$	35	70	140	280	420	560	700	V
Forward current	$I_F$	1							A
Peak forward surge current, 8.3ms single half sine-wave superimposed on rated load	$I_{FSM}$	50							A
Rating for fusing ( $t < 8.3\text{ms}$ )	$I^2t$	10.3							A <sup>2</sup> s
Junction temperature	$T_J$	- 55 to +150							°C
Storage temperature	$T_{STG}$	- 55 to +150							°C

<b>THERMAL PERFORMANCE</b>			
<b>PARAMETER</b>	<b>SYMBOL</b>	<b>TYP</b>	<b>UNIT</b>
Junction-to-lead thermal resistance	$R_{\theta JL}$	15	°C/W
Junction-to-ambient thermal resistance	$R_{\theta JA}$	40	°C/W

<b>ELECTRICAL SPECIFICATIONS</b> ( $T_A = 25^\circ\text{C}$ unless otherwise noted)								
<b>PARAMETER</b>		<b>CONDITIONS</b>	<b>SYMBOL</b>	<b>TYP</b>	<b>MAX</b>	<b>UNIT</b>		
Forward voltage per diode <sup>(1)</sup>	HDBLS101G HDBLS102G HDBLS103G	$I_F = 1\text{A}, T_J = 25^\circ\text{C}$	$V_F$	-	1.0	V		
	HDBLS104G			-	1.3	V		
	HDBLS105G HDBLS106G HDBLS107G			-	1.7	V		
	Reverse current @ rated $V_R$ per diode <sup>(2)</sup>			$T_J = 25^\circ\text{C}$	$I_R$	-	5	$\mu\text{A}$
				$T_J = 125^\circ\text{C}$		-	500	$\mu\text{A}$
Reverse recovery time	HDBLS101G HDBLS102G HDBLS103G HDBLS104G	$I_F = 0.5\text{A}, I_R = 1.0\text{A},$ $I_{rr} = 0.25\text{A}$	$t_{rr}$	-	50	ns		
	HDBLS105G HDBLS106G HDBLS107G			-	75	ns		

**Notes:**

1. Pulse test with  $PW = 0.3\text{ms}$
2. Pulse test with  $PW = 30\text{ms}$

<b>ORDERING INFORMATION</b>		
<b>ORDERING CODE</b> <sup>(1)(2)</sup>	<b>PACKAGE</b>	<b>PACKING</b>
HDBLS1xG	DBLS	1,500 / Tape & Reel
HDBLS1xGH	DBLS	1,500 / Tape & Reel

**Notes:**

1. "x" defines voltage from 50V(HDBLS101G) to 1000V(HDBLS107G)
2. "H" means AEC-Q101 qualified

**CHARACTERISTICS CURVES**

( $T_A = 25^\circ\text{C}$  unless otherwise noted)

**Fig.1 Forward Current Derating Curve**

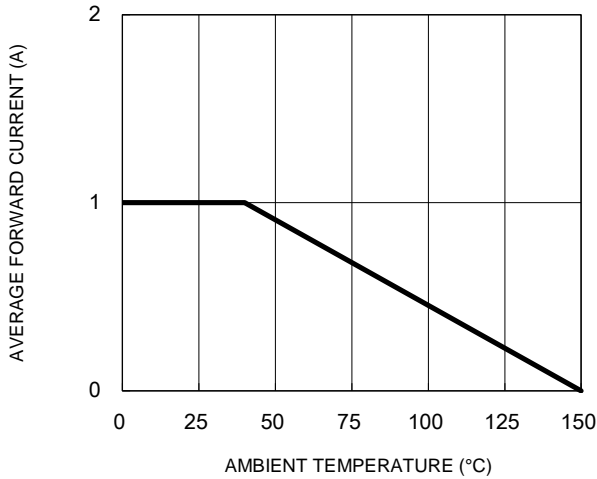

**Fig.2 Typical Junction Capacitance**

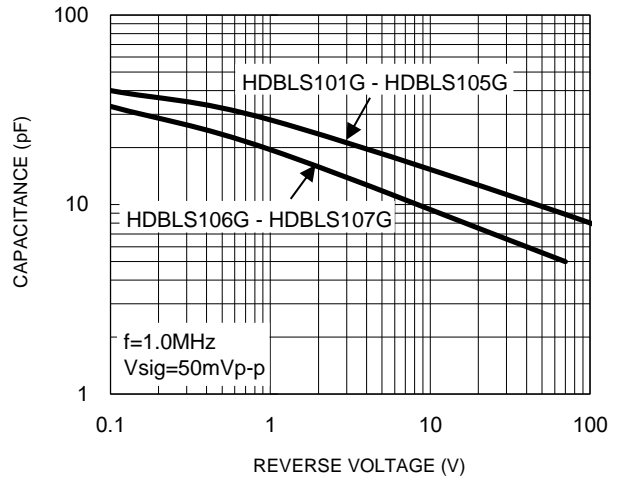

**Fig.3 Typical Reverse Characteristics**

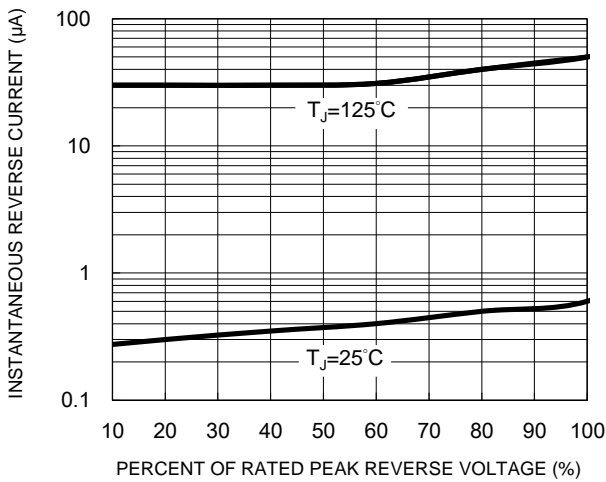

**Fig.4 Typical Forward Characteristics**

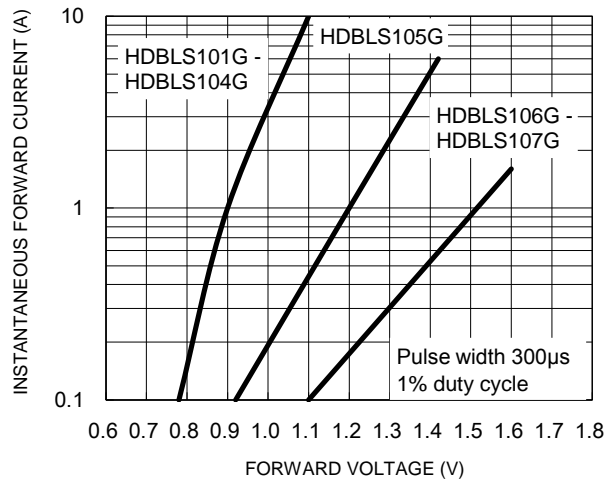

**Fig.5 Maximum Non-Repetitive Forward Surge Current**

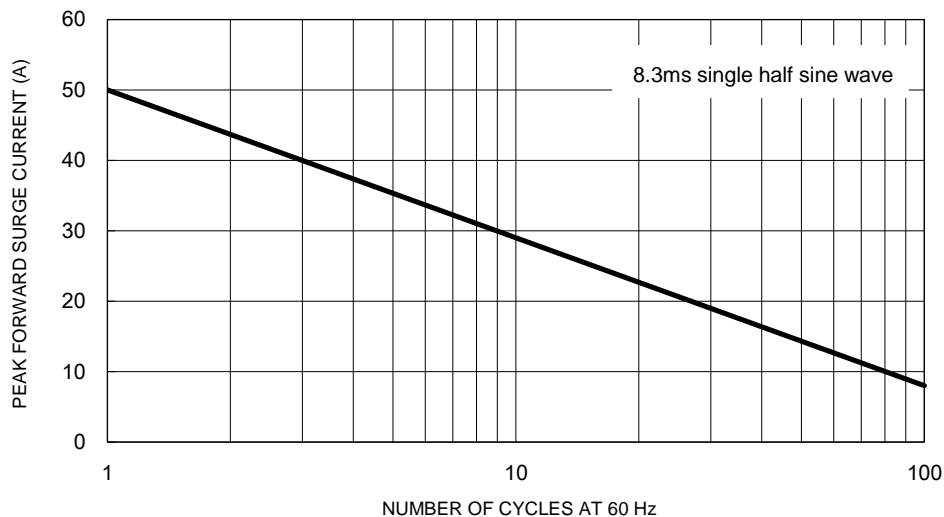

**CHARACTERISTICS CURVES**

( $T_A = 25^\circ\text{C}$  unless otherwise noted)

**Fig.6 Reverse Recovery Time Characteristic and Test Circuit Diagram**

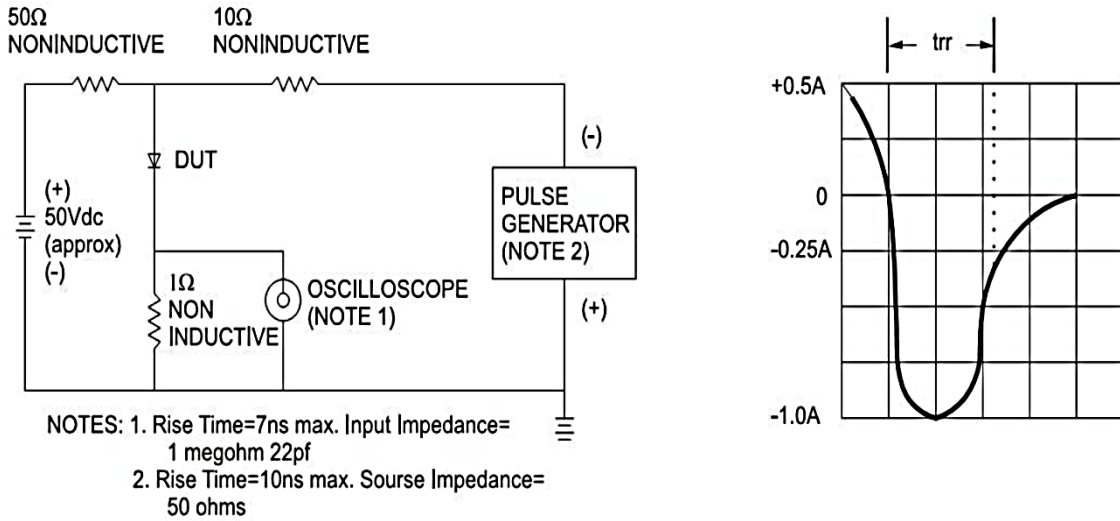

**PACKAGE OUTLINE DIMENSIONS**

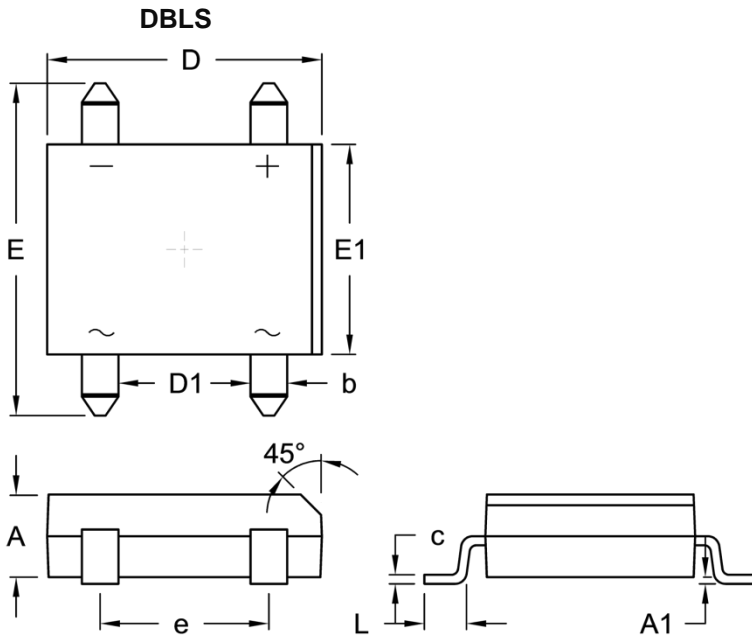

DIM.	Unit (mm)		Unit (inch)	
	Min.	Max.	Min.	Max.
A	2.40	2.60	0.094	0.102
A1	0.076	0.330	0.003	0.013
b	1.02	1.20	0.040	0.047
c	0.22	0.33	0.009	0.013
D	8.13	8.51	0.320	0.335
D1	3.90	4.10	0.154	0.161
E	9.80	10.30	0.386	0.406
E1	6.20	6.50	0.244	0.256
e	5.00	5.20	0.197	0.205
L	1.02	1.53	0.040	0.060

**SUGGESTED PAD LAYOUT**

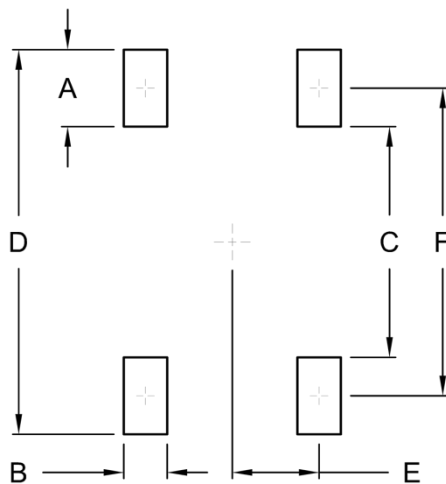

Symbol	Unit (mm)	Unit (inch)
A	2.30	0.091
B	1.30	0.051
C	6.90	0.272
D	11.50	0.453
E	2.60	0.102
F	9.20	0.362

**MARKING DIAGRAM**



- P/N = Marking Code
- G = Green Compound
- YW = Date Code
- F = Factory Code

## **Notice**

Specifications of the products displayed herein are subject to change without notice. TSC or anyone on its behalf, assumes no responsibility or liability for any errors or inaccuracies.

Purchasers are solely responsible for the choice, selection, and use of TSC products and TSC assumes no liability for application assistance or the design of Purchasers' products.

Information contained herein is intended to provide a product description only. No license, express or implied, to any intellectual property rights is granted by this document. Except as provided in TSC's terms and conditions of sale for such products, TSC assumes no liability whatsoever, and disclaims any express or implied warranty, relating to sale and/or use of TSC products including liability or warranties relating to fitness for a particular purpose, merchantability, or infringement of any patent, copyright, or other intellectual property right.

The products shown herein are not designed for use in medical, life-saving, or life-sustaining applications. Customers using or selling these products for use in such applications do so at their own risk and agree to fully indemnify TSC for any damages resulting from such improper use or sale.

## Looking for pricing, stock, or lifecycle information?

Click below to explore more details on WIN SOURCE:

- [View HDBLS106G on WIN SOURCE](#)
- [Taiwan Semiconductor Information](#)

## Optimize Your Supply Chain with WIN SOURCE Solutions

- ✓ Global Sourcing Solution
- ✓ Obsolete Management
- ✓ Cost Control Management
- ✓ Shortage Management
- ✓ Alternative Solution
- ✓ Excess Inventory Management