

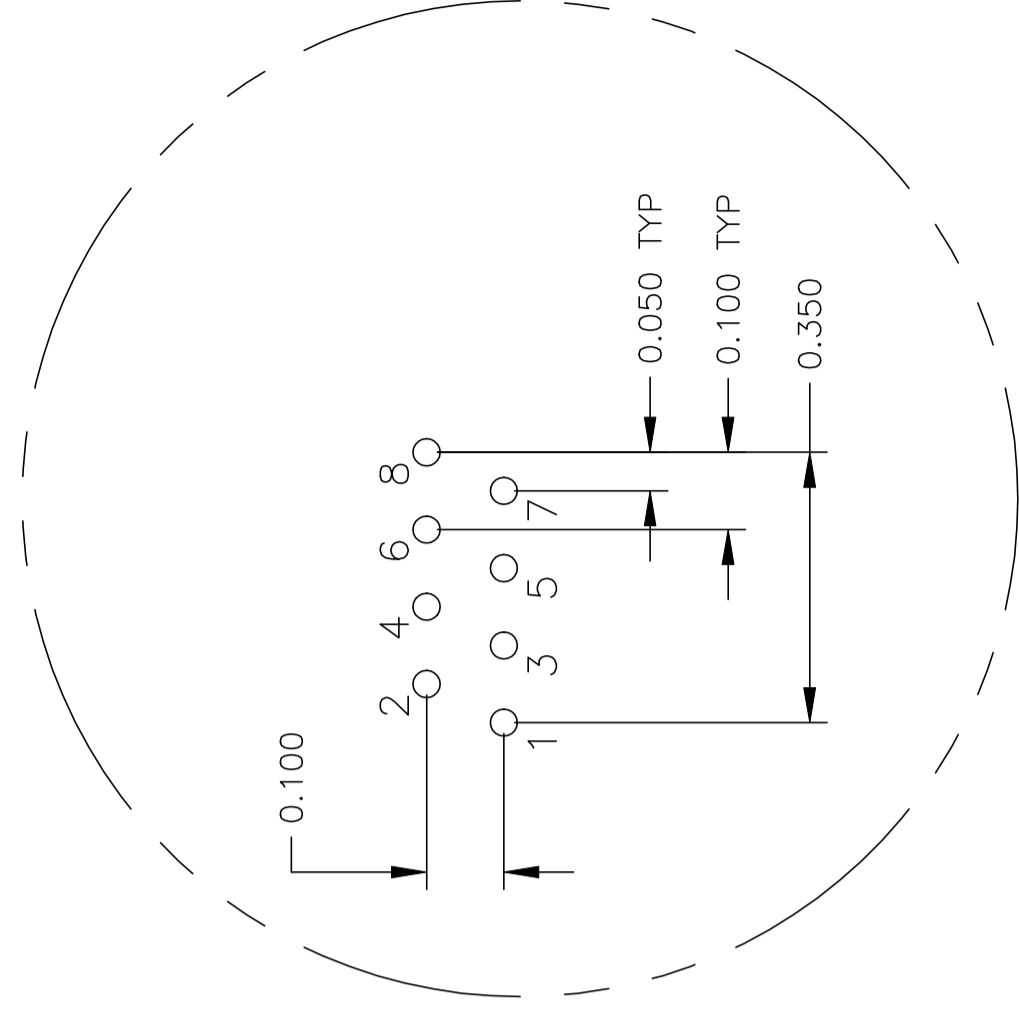

THE DATASHEET OF
6605841-1

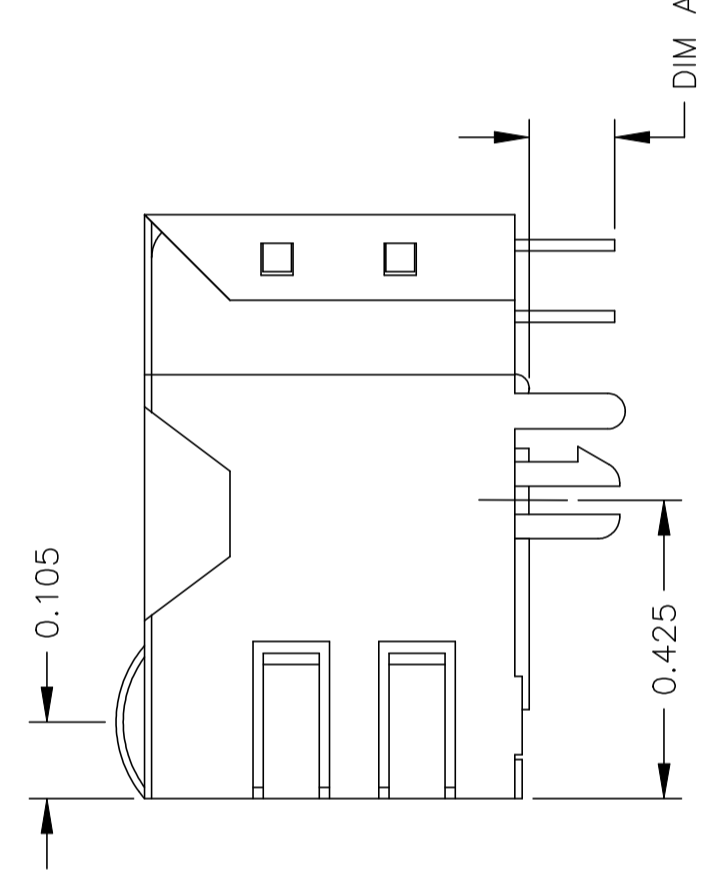

MECHANICAL:

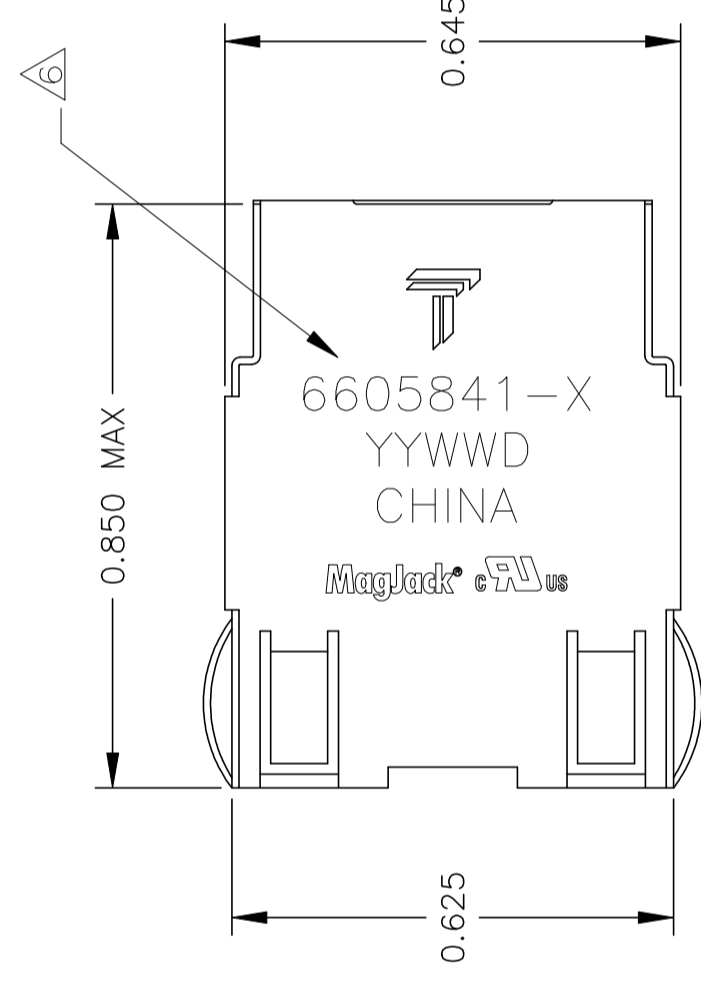
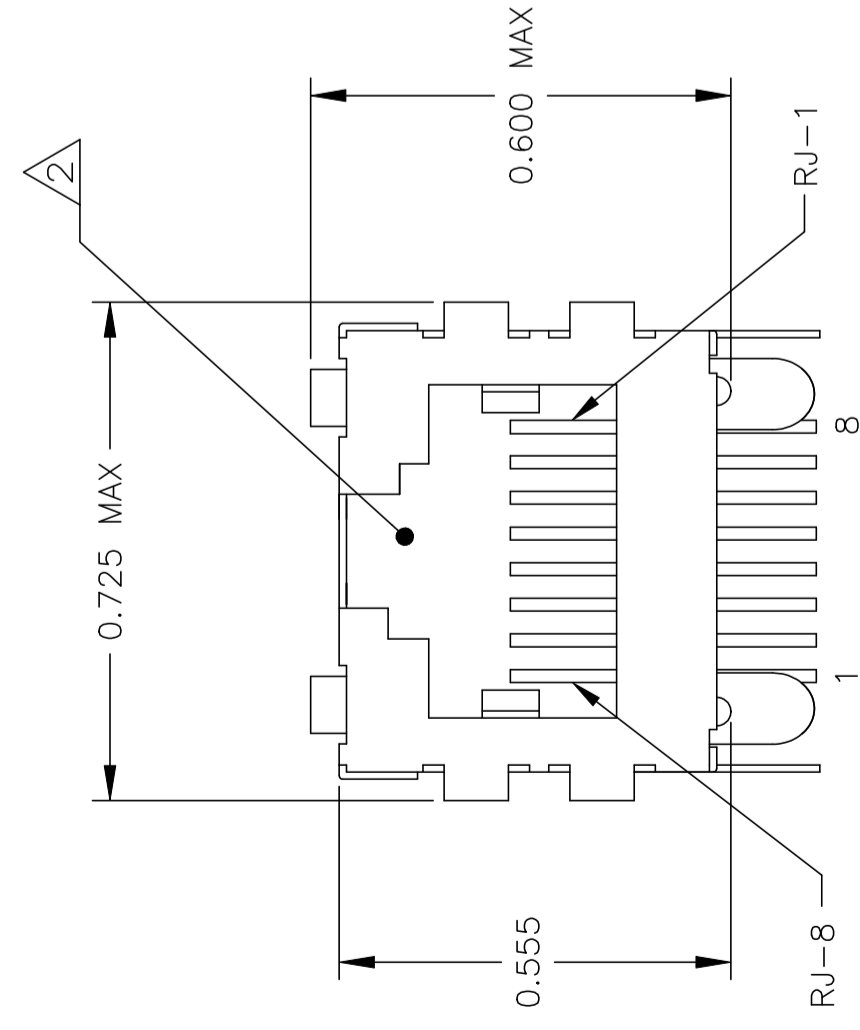

Pin Designations

726ET SERIES MAGNETIC CIRCUIT

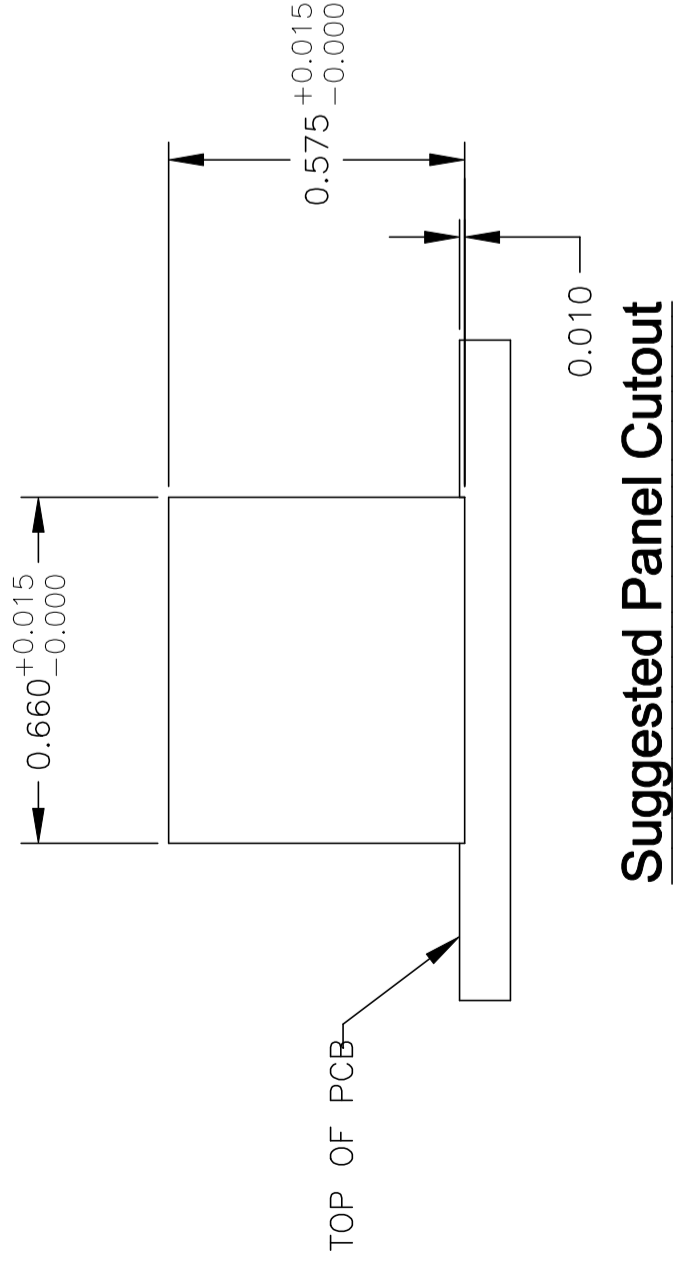
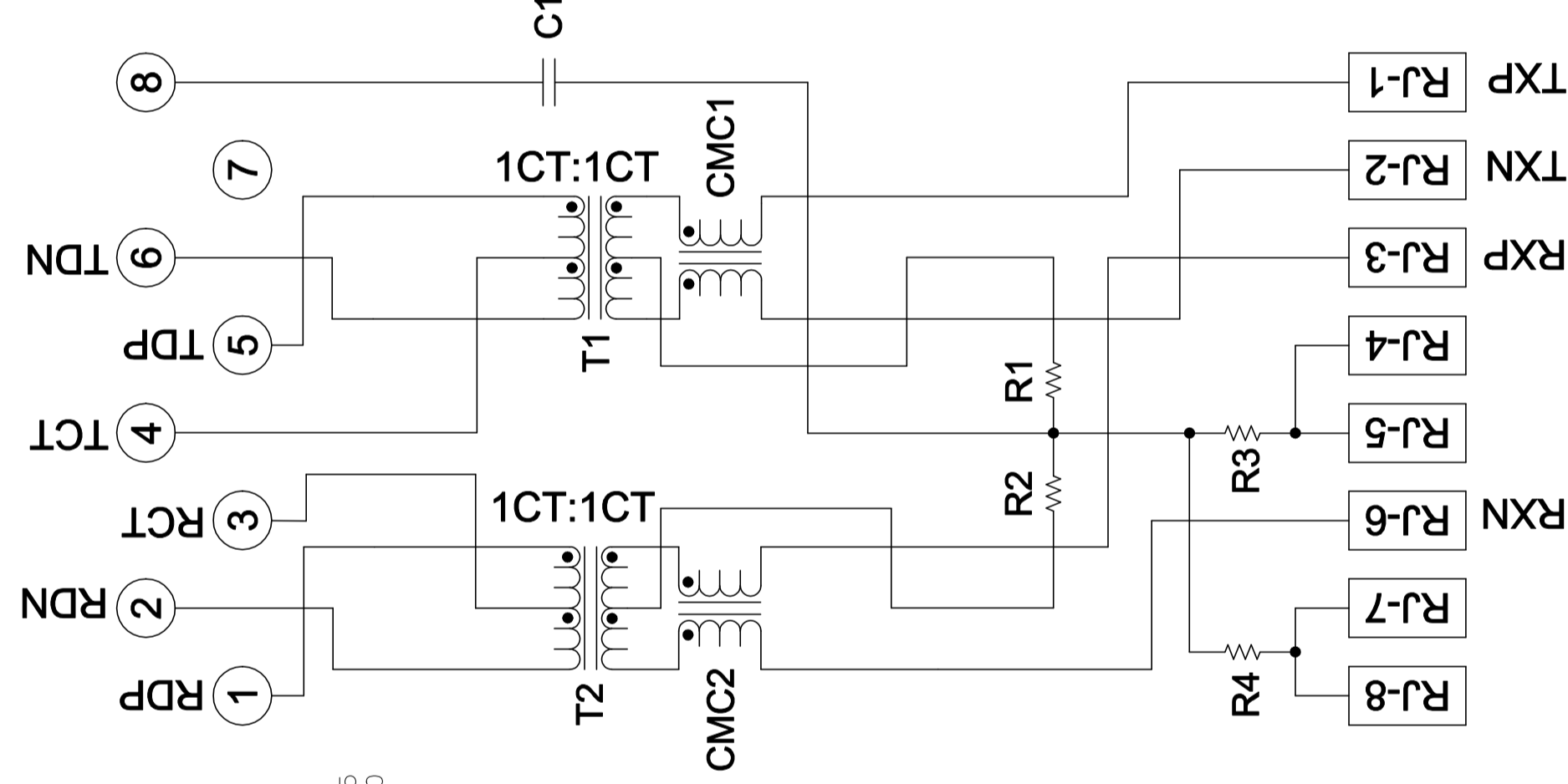

Suggested Panel Cutout

SHIELD

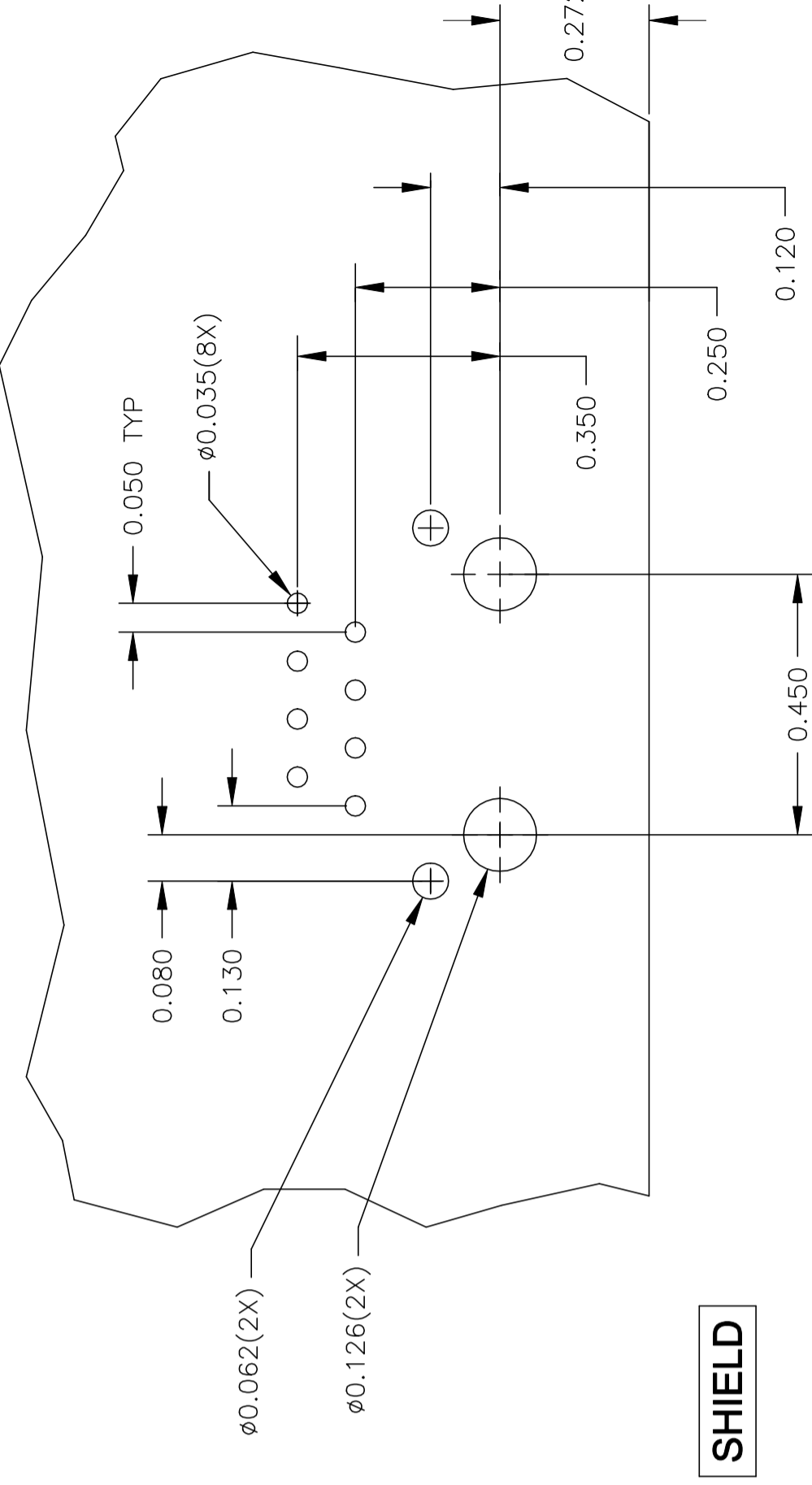

**Suggested PCB Layout
(Component Side)**

SHIELD

C1 = 1000 pF, 2kV CAPACITOR
 R1-R4 = 75 OHMS, 1/16W RESISTORS

Looking for pricing, stock, or lifecycle information?

Click below to explore more details on WIN SOURCE:

 [View 6605841-1 on WIN SOURCE](#)

 [Bel Fuse Inc. Information](#)

Optimize Your Supply Chain with WIN SOURCE Solutions

-  Global Sourcing Solution
-  Obsolete Management
-  Cost Control Management
-  Shortage Management
-  Alternative Solution
-  Excess Inventory Management