



THE DATASHEET OF
07-8-250



3M™ Specialty Wire Terminals Catalog



Easy-to-Install
High Performance
Terminals



Table of Contents

Section	Page
Specialty Wire Terminals, Kits and Tools	5-84
3M™ Terminals	12-58
3M™ Highland™ Terminals	59-64
3M™ Specialty Bagged Terminals	65-82
Kits and Tools.....	83-84

Table of Contents

Table of Contents

Specialty Wire Terminals, Kits and Tools

3M has been a leading supplier of terminals for more than 30 years. Our satisfied customers know our products for:

- Effective and reliable performance.
- Variety of types, sizes and materials that meet a broad application range, including the demands of temperature and weather.
- Design features assuring easy installation of 3M products—positive and easy wire insertion, virtually eliminates strand hang-ups and wire twisting, and easy insulation entry.



These are a few of the characteristics that help make the installer's job easier.

Our terminals allow for various insulation types (such as heat shrink, nylon, vinyl, or non-insulated). Various barrel styles are available (such as butted, brazed, seamless, or interlocking barrel). Additionally, our premier terminals come in bottle or bulk packaging.

3M™ Highland™ Terminals are either vinyl or nylon insulated with a butted seam. They come packaged in small quantities in reclosable plastic bags.

3M Terminals help accommodate the installer's needs.

Glossary of Terminals and Tools Terms

ADAPTERS

To interconnect two connectors already attached to wires.

BLOCK FORK

Same strength as the fork, but designed to use in terminal block because sides lie flat against barrier portion of terminal block.

BULLET STYLE SNAP PLUG

Similar advantages as disconnects. Gives reliable in-line connection because parts are made to have holding friction when joined. Usually for automotive use.

BUTT

Uses chamfered barrel ends to provide fast, easy wire insertion from both ends and a built-in wire stop for correct positioning. Must be crimped at both ends.

CLOSED-END

Used in situations requiring pigtail of two or more wires.

FLANGED FORK

Gives the benefit of both the block and locking forks. Stays secure should screw loosen.

FORK

Allows rapid connection of wire. Usually used on free-standing studs, because of wider tongues.

HOOK

Combines the security of the ring with the convenience of the forks.

LOCKING FORK

The spring-like tongue locks in place around the stud even when mount screw is not tightened. Extra force is required to remove from stud.

PARALLEL

Similar to butt with overlapped wires and single crimp in center of connector. Used where space is limited.

PINS

For installation in compression blocks. Used in Europe for terminating stranded wire.

QUICK CONNECT (DISCONNECT)

Attached to mating part by tongue of female part slipping over male tab. Use of dents and rolled edges on female part provides excellent holding force while allowing easy and quick disconnect.

RING

The standard style of tongue. The safest and most reliable 3M terminal. It cannot be removed unless mounting screw is removed.

TAB

Uses mounting hole for rivet or screw.

TAP

No wire stripping is necessary, just lay wire in connector and crimp. Connection is made.

Standard Terminal Construction

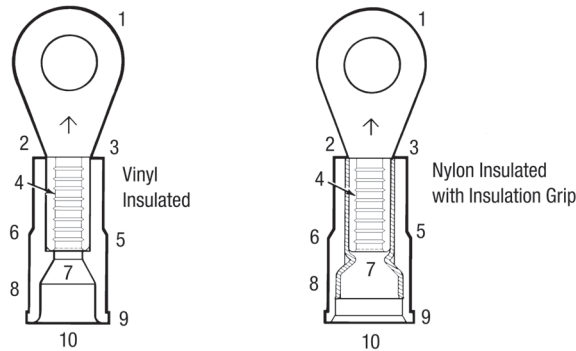

3M™ Terminals provide a variety of design features assuring consistently effective, reliable performance and easy installation.

Please refer to the illustrations at the numbered locations for the attributes described below.

1. One-piece, burr-free construction provides maximum electrical conductivity. Electrical bright-tin plating gives maximum corrosion resistance. Annealing relieves stress points and provides maximum installed strength.
2. Barrel-to-pad transition design minimizes flexing and bending.
3. Open-end design permits visual inspection of wire location before and after crimping.
4. Maximum hold on wire comes from multiple “V” grooves in #22–4 AWG parts resulting in excellent holding power.
5. Injection molded insulations on terminals are the highest quality in the industry.
 - 221°F (105°C)* rated, tough, resistant electrical grade materials
 - Molding ensures consistent wall thickness for maximum reliability after crimping
 - Molding allows funnel barrel construction for easier installation
 - Molding offers the crimp ridge and non-slip ridge
6. Crimp ridge designed for positive location of tool on terminal barrel, resulting in few miscrimps.
7. Funnel barrel construction provides:
 - Positive, easy wire insertion
 - Virtually no hang-ups of wire strands
 - Wire twisting not necessary

8. Nylon-insulated terminals with grip feature a brass sleeve. Sleeve provides optimum grip on insulation, strain relief and vibration protection. Brass sleeve is recessed which provides excellent flash-over protection.

9. Non-slip ridge so tool slides to correct position for a proper crimp and better workmanship.

10. Beveled leading edge for easy wire insulation entry.

Barrel Styles

Non-Insulated Butted Seam

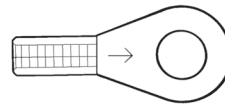

The most economical 3M terminal—used where special performance or installation characteristics are not needed. Beveled mouth facilitates wire insertion. Maximum temperature for bare terminals: 347°F (175°C).

Non-Insulated Brazed Seam

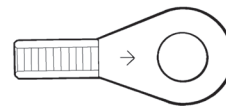

Beveled mouth facilitates wire insertion. Can be crimped anywhere on barrel surface. Silver brazed seam will not open under crimping pressure or operating stresses. Unlike butted seam parts, stranded wire cannot escape barrel confines during or after crimping. Maximum temperature for bare terminals: 347°F (175°C).

Vinyl Insulated Brazed and Butted Seams

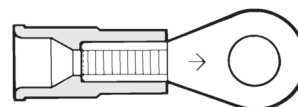

Used where insulated barrel is necessary and desirable. Terminal consists of brazed or butted part with flared, rigid molded polyvinyl chloride sleeve securely attached and funneled for easy wire entry. Wire insulation positions itself against funnel portion of vinyl sleeve thus virtually eliminating strand hang-up. Crimping barrel and flared portion of sleeve provide excellent electrical contact plus mechanical stress relief at junction of insulation and barrel. Insulation has a non-slip ridge for ease of positioning crimping tool.

*Products made in U.S.A. only.

Nylon Insulated Butted Seam with Insulation Grip

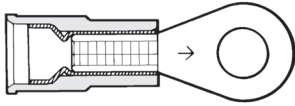

Used where insulated barrel and positive insulation grip are necessary or desirable. Terminal consists of butted seam part with flared, seamless brass sleeve securely attached and covered with flared, molded nylon sleeve. Wire insulation positions itself against funnel portion of brass sleeve. Crimping barrel and flared portion of sleeve provide excellent electrical contact plus mechanical stress relief at junction of insulation and barrel. Positioning crimp tool is nearly mistake proof due to a “step” in nylon insulation. Industry standard color coding indicates wire range. Insulators are rated at a continuous operating temperature range from -40°F to 221°F (-40°C to 105°C)*.

UL Listed and CSA Certified for 600V building wire and 1000V signs and lighting fixtures (luminaries)*.

Installation Procedure

Funnel Barrel Feature provides an excellent electrical and mechanical connection.

- Funnel design guides wire into position.

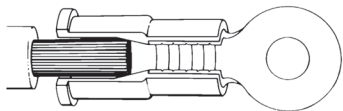

- No wire strand hang-up as the wire is inserted, giving a fast, positive installation.

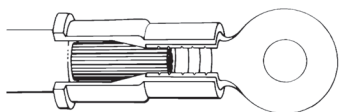

- Wire is in place, ready for crimping.

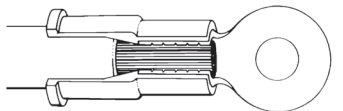

For maximum crimping performance, barrel of connector must be properly indexed in the crimp tool station.

*Products made in U.S.A. only.

Correct crimping is important to assure a strong connection.

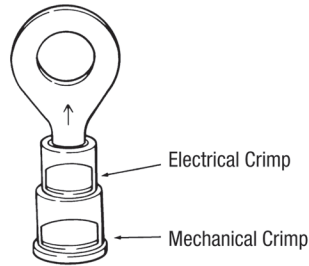

Insulated Terminals and Connectors:



Non-Insulated Terminals and Connectors:

Indent should be opposite the barrel seam.

Heat Shrink Terminals, Connectors and Disconnects

3M™ Heat Shrink Pre-insulated Terminals, Connectors and Disconnects protect against the most challenging of environments, making the best moisture protection available. They offer several advantages over conventional unsealed products.

Corrosion Resistance

The adhesive-lined heat shrink material, when properly crimped and shrunk, provides a seal resistant to water, salt, steam and other related contaminants.

Improved Mechanical Performance

The adhesive-lined heat shrink tubing adheres, when shrunk, to both the connector and the wire insulation providing improved pullout strength and strain relief.

Durable Heat Shrink Tubing

Tough heat shrink tubing effectively resists abrasion, scoring, cut-through, and the effects of long-term aging.

Versatile and Easy to Use

3M heat shrink terminals, splices and disconnects are available in wire sizes 22–10 AWG and can be installed easily with a recommended tool and heat source. The connectors are color-coded for wire range identification and the transparent tubing allows for visual inspection.

Application Procedure for Heat Shrink Products:

1. Strip wires to appropriate length as indicated on package label.



2. Insert wire into terminal and crimp with correct station of a recommended tool.



3. Apply heat with a recommended heat source.



High Temperature Terminals and Connectors

3M™ High Temperature Terminals and Connectors are constructed of steel with a nickel plating. Their temperature rating for continuous use at 900°F (482°C) makes them ideal for use in ovens, motors, light fixtures and other applications where other connectors could corrode or melt.

There is no applicable UL or CSA standard for high temperature steel parts.

Standard Crimp Terminal and Connector Specifications

Materials

Crimp terminals and connectors are to be burr-free, annealed and bright-tin plated ETP copper. Barrels shall be 0.25" long with brazed seams where specified. Insulation grip sleeves are to be tin-plated brass and attached securely to the barrel. Terminal insulators are to be molded polyvinyl chloride or nylon, UL Listed and CSA Certified for 600V in building wire and 1000V in signs and lighting fixtures (luminaries)*. Connector insulators are to be extruded polyvinyl chloride or nylon with a temperature rating of 221°F (105°C)*.

Construction

Most insulated terminals are to have funnel entry construction* to prevent strand hang-up and a crimp ridge for proper tool location. Nylon insulated terminals and connectors are to have butted seam barrels with insulation grip sleeves. Terminal barrels are to have multiple “V” grooves for maximum conductor retention.

*Products made in U.S.A. only.

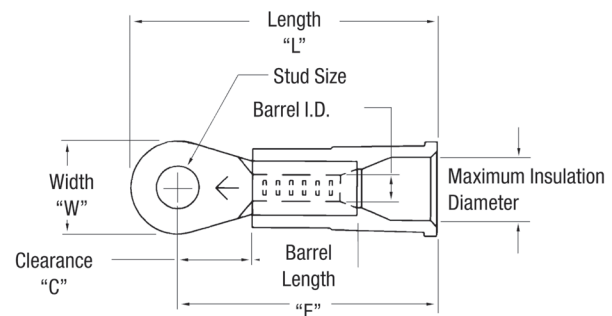

Note: All dimensions are measured in inches.

FREQUENTLY ASKED QUESTIONS

What does the insulation grip do?

The insulation grip provides a “second” crimp on the wire insulation providing additional wire strain relief. It’s excellent for high vibration applications.

What’s the difference between insulated and fully insulated disconnects?

Insulated disconnects have barrel insulation only and fully insulated disconnects are insulated from the barrel to the receptacle/tab.

What temperatures do 3M terminals withstand?

Non-insulated 3M terminals withstand temperatures up to 347°F (175°C). Insulated 3M terminals withstand temperatures up to 221°F (105°C).

3M™ Terminal Numbering System

Prefix	Terminal Style	Wire Gauge	Additions	Stud Size	Pattern	Diameter or Blade Size	Terminal Construction
BS = Block Fork	1 = Ring Tongue	0 = #26-24 AWG, Yellow	C = Locking Clip	0 = #0	S=Small	110-20 = 0.110 Blade	No Code = Butted Seam
HT = High Temperature	2 = Flanged Fork		F = Female	2 = #2		0.020 Stock	B = Insulation Grip
L = Long Neck	3 = Fork or 3-Way	1 = #22-18 AWG, Red	FF = Double Female	4 = #4		110-32 = 0.110 Blade	L = Fully Insulated
SS = Snap Fork	4 = Hook or 4-Way		I = Interlock Barrel	6 = #6		0.032 Stock	M = Moisture Resistant
T = T-Tap	5 = Flag Ring	2 = #16-14 AWG, Blue	M = Male	8 = #8		156 = 0.156 Bullet Diameter	N = Nylon Insulation
	6 = Butt		MF = Male Female	10 = #10		180 = 0.180 Bullet Diameter	NS = Nylon w/ Steel Sleeve
	7 = Disconnect or Closed End	3 = #12-10 AWG, Yellow	MM = Double Male	14 = #1/4"		187-20 = 0.187 Blade	P = Vinyl Insulated
	8 = Bullet Style or Pin	4 = #8 AWG, Red	O = Open Barrel	26 = #2, 4, 6		0.020 Stock	S = Seamless
	9 = Parallel	5 = #6 AWG, Blue	SC = Semi-Closed	38 = #3/8"		187-32 = 0.187 Blade	SN = Seamless Nylon
	17 = Ring Tongue Tab	6 = #4 AWG, Yellow	WN = Brazed Seam Nylon	56 = #5/16"		0.032 Stock	SP = Seamless Vinyl
	75 = Disconnect Flag	12 = #12-10, Yellow	WP = Brazed Seam Vinyl	58 = #5/8"		375-50 = 0.375 Blade	W = Brazed Seam
	77 = Multi-Stack	16 = #16-14, Blue		75 = #3/4"		0.050 Stock	
		18 = #18-10, White		500 = #1/2"			
		22 = #22-18, Red or #22-14, White"		610 = #6, 8, 10			
		"23 = #16-12 AWG, Yellow or #14-12 AWG, Red"		716 = #7/16"			
		0-3 = #16-14, 0.156 diameter					

Product numbers ending with "-A" are made in Taiwan.

Map of Numbering System

Example:

Catalog Number: BS-31-4S-W
Non-Insulated Brazed Seam Block Fork

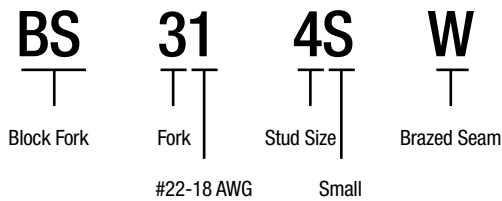



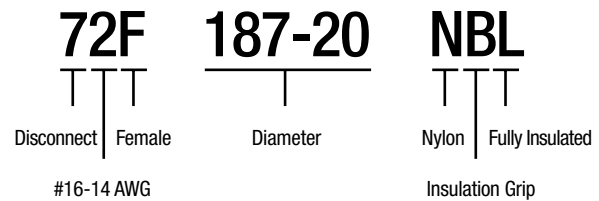























Catalog Number: 71F-187-20-NBL
Nylon Insulated with Insulation Grip Female Disconnect



Insulator Color Coding

Yellow (26-24 AWG) Red (22-18 AWG) Blue (16-14 AWG) Yellow (12-10 AWG) Red (8 AWG) Blue (6 AWG) Yellow (4 AWG)

3M™ Terminal Stud Size Chart

	Stud Size			3M Terminal Hole Diameter
	US/Inches	Diameter	OUS/Metric	
#2		0.086" (2,144 mm)	M2	
#4		0.112" (2,844 mm)	M2,5	
#5		0.125" (3,175 mm)	M3	
#6		0.138" (3,505 mm)	M3,5	
#8		0.164" (4,166 mm)	M4	
#10		0.190" (4,826 mm)	M5	
1/4		0.250" (6,350 mm)	M6	
5/16		0.3125" (7,938 mm)	M8	
3/8		0.375" (9,525 mm)	M10	
7/16		0.4375" (11,113 mm)	M10	
1/2		0.500" (12,700 mm)	M12	
5/8		0.625" (15,875 mm)	M16	
3/4		0.750" (19,050 mm)	M18	

Ref: ISO 263-1973 for inch stud sizes and ISO 262-1973 for metric stud sizes.

American Wire Gauge

Size	Inches	Millimeters	Size	Inches	Millimeters	Size	Inches	Millimeters
4/0	0.4600	11,684	4	0.2043	5,189	16	0.0508	1,290
3/0	0.4096	10,040	6	0.1620	4,115	18	0.0403	1,024
2/0	0.3648	9,266	8	0.1285	3,264	20	0.0320	0,813
1/0	0.3249	8,253	10	0.1019	2,588	22	0.0253	0,643
1	0.2893	7,347	12	0.0808	2,052	24	0.0201	0,511
2	0.2576	6,543	14	0.0641	1,628	26	0.0159	0,404

Specialty Wire Terminals, Kits and Tools

3M™ Terminals: 3M™ Ring Tongues

Non-Insulated Butted Seam Ring Tongue

Terminal Type Ring
 Terminal Style Standard
 Insulation Material Non-Insulated
 Barrel Style Butted
 RoHS 2011/65/EU Yes

Agency Approval



Manufacturing Origin

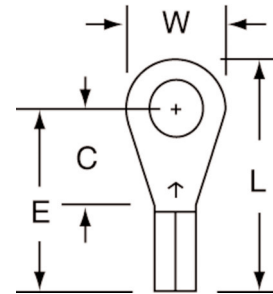

Product No.	UPC	Conductor Size	Stud Size	(W)	(C)	(L)	(E)	Thickness	Barrel I.D.
11-4S	054007-27911	22 - 18 AWG	4	0.25"	0.22"	0.60"	0.47"	0.030"	0.070"
11-6S	054007-27913	22 - 18 AWG	6	0.25"	0.22"	0.60"	0.47"	0.030"	0.070"
11-8	054007-27918	22 - 18 AWG	8	0.33"	0.29"	0.70"	0.54"	0.030"	0.070"
11-10	054007-27920	22 - 18 AWG	10	0.33"	0.29"	0.70"	0.54"	0.030"	0.070"
L-11-10	054007-27921	22 - 18 AWG	10	0.31"	0.33"	0.74"	0.58"	0.030"	0.070"
11-14S	054007-27922	22 - 18 AWG	1/4"	0.47"	0.40"	0.89"	0.65"	0.030"	0.070"
11-56S	054007-27924	22 - 18 AWG	5/16"	0.47"	0.40"	0.88"	0.65"	0.030"	0.070"
11-38	054007-27926	22 - 18 AWG	3/8"	0.56"	0.40"	0.93"	0.65"	0.030"	0.070"
12-4S	054007-28314	16 - 14 AWG	4	0.25"	0.22"	0.60"	0.47"	0.030"	0.090"
12-6S	054007-28316	16 - 14 AWG	6	0.25"	0.22"	0.60"	0.47"	0.030"	0.090"
12-8S	054007-28319	16 - 14 AWG	8	0.25"	0.22"	0.60"	0.47"	0.030"	0.090"
12-8	054007-28320	16 - 14 AWG	8	0.33"	0.29"	0.70"	0.54"	0.030"	0.090"
L-12-10	054007-28323	16 - 14 AWG	10	0.31"	0.33"	0.74"	0.58"	0.030"	0.090"
12-10	054007-28322	16 - 14 AWG	10	0.33"	0.29"	0.70"	0.54"	0.030"	0.090"
12-14S	054007-28324	16 - 14 AWG	1/4"	0.47"	0.40"	0.89"	0.65"	0.030"	0.090"
12-56S	054007-28326	16 - 14 AWG	5/16"	0.47"	0.40"	0.88"	0.65"	0.030"	0.090"
12-56	054007-28327	16 - 14 AWG	5/16"	0.56"	0.40"	0.93"	0.65"	0.030"	0.090"
12-38	054007-28328	16 - 14 AWG	3/8"	0.56"	0.40"	0.93"	0.65"	0.030"	0.090"
13-6S	054007-28720	12 - 10 AWG	6	0.28"	0.29"	0.68"	0.54"	0.040"	0.135"
13-6	054007-28721	12 - 10 AWG	6	0.38"	0.29"	0.73"	0.54"	0.040"	0.135"
13-8	054007-28723	12 - 10 AWG	8	0.38"	0.29"	0.73"	0.54"	0.040"	0.135"
13-10	054007-28724	12 - 10 AWG	10	0.38"	0.29"	0.73"	0.54"	0.040"	0.135"
13-14S	054007-28725	12 - 10 AWG	1/4"	0.53"	0.44"	0.96"	0.69"	0.040"	0.135"
13-14	054007-28726	12 - 10 AWG	1/4"	0.59"	0.44"	0.99"	0.69"	0.040"	0.135"
13-56S	054007-28727	12 - 10 AWG	5/16"	0.53"	0.44"	0.96"	0.69"	0.040"	0.135"
13-56	054007-28728	12 - 10 AWG	5/16"	0.59"	0.44"	0.99"	0.69"	0.040"	0.135"
13-38	054007-28730	12 - 10 AWG	3/8"	0.59"	0.44"	0.99"	0.69"	0.040"	0.135"
13-500	054007-28732	12 - 10 AWG	1/2"	0.75"	0.57"	1.20"	0.82"	0.040"	0.135"

Specialty Wire Terminals, Kits and Tools

3M™ Terminals: 3M™ Ring Tongues

Non-Insulated Brazed Seam Ring Tongue

Terminal Type Ring
 Terminal Style Standard
 Insulation Material Non-Insulated
 Barrel Style Brazed
 RoHS 2011/65/EU Yes

Agency Approval  

Manufacturing Origin 

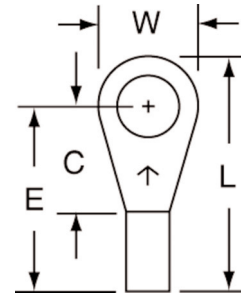

Product No.	UPC	Conductor Size	Stud Size	(W)	(C)	(L)	(E)	Thickness	Barrel I.D.
11-2S-W	054007-27927	22 - 18 AWG	2	0.25"	0.23"	0.60"	0.48"	0.030"	0.070"
11-4S-W	054007-27928	22 - 18 AWG	4	0.25"	0.22"	0.60"	0.47"	0.030"	0.070"
11-6S-W	054007-27930	22 - 18 AWG	6	0.25"	0.22"	0.60"	0.47"	0.030"	0.070"
L-11-6-W	054007-27933	22 - 18 AWG	6	0.31"	0.33"	0.74"	0.58"	0.030"	0.070"
11-8-W	054007-27935	22 - 18 AWG	8	0.33"	0.29"	0.70"	0.54"	0.030"	0.070"
L-11-8-W	054007-27936	22 - 18 AWG	8	0.31"	0.33"	0.74"	0.58"	0.030"	0.070"
11-10-W	054007-27937	22 - 18 AWG	10	0.33"	0.29"	0.70"	0.54"	0.030"	0.070"
L-11-10-W	054007-27938	22 - 18 AWG	10	0.31"	0.33"	0.74"	0.58"	0.030"	0.070"
11-14S-W	054007-27939	22 - 18 AWG	1/4"	0.47"	0.40"	0.89"	0.65"	0.030"	0.070"
11-56S-W	054007-27941	22 - 18 AWG	5/16"	0.47"	0.40"	0.88"	0.65"	0.030"	0.070"
11-38-W	054007-27943	22 - 18 AWG	3/8"	0.56"	0.40"	0.88"	0.65"	0.030"	0.070"
12-4S-W	054007-28330	16 - 14 AWG	4	0.25"	0.22"	0.60"	0.47"	0.030"	0.090"
12-6S-W	054007-28332	16 - 14 AWG	6	0.25"	0.22"	0.60"	0.47"	0.030"	0.090"
12-6-W	054007-28333	16 - 14 AWG	6	0.33"	0.29"	0.70"	0.54"	0.030"	0.090"
L-12-6-W	054007-28334	16 - 14 AWG	6	0.31"	0.33"	0.74"	0.58"	0.030"	0.090"
12-8S-W	054007-28335	16 - 14 AWG	8	0.25"	0.22"	0.60"	0.47"	0.030"	0.090"
12-8-W	054007-28336	16 - 14 AWG	8	0.33"	0.29"	0.70"	0.54"	0.030"	0.090"
L-12-8-W	054007-28337	16 - 14 AWG	8	0.31"	0.33"	0.74"	0.58"	0.030"	0.090"
12-10-W	054007-28338	16 - 14 AWG	10	0.33"	0.29"	0.70"	0.54"	0.030"	0.090"
L-12-10-W	054007-28339	16 - 14 AWG	10	0.31"	0.33"	0.74"	0.58"	0.030"	0.090"
12-14S-W	054007-28340	16 - 14 AWG	1/4"	0.47"	0.40"	0.89"	0.65"	0.030"	0.090"
12-14-W	054007-28341	16 - 14 AWG	1/4"	0.56"	0.40"	0.93"	0.65"	0.030"	0.090"
12-38-W	054007-28344	16 - 14 AWG	3/8"	0.56"	0.40"	0.93"	0.65"	0.030"	0.090"
12-56S-W	054007-28342	16 - 14 AWG	5/16"	0.47"	0.40"	0.89"	0.65"	0.030"	0.090"
12-56-W	054007-28343	16 - 14 AWG	5/16"	0.56"	0.40"	0.93"	0.65"	0.030"	0.090"
13-6S-W	054007-28734	12 - 10 AWG	6	0.28"	0.29"	0.68"	0.54"	0.040"	0.135"
13-6-W	054007-28735	12 - 10 AWG	6	0.38"	0.29"	0.73"	0.54"	0.040"	0.135"
13-8S-W	054007-28736	12 - 10 AWG	8	0.28"	0.29"	0.68"	0.54"	0.040"	0.135"
13-8-W	054007-28737	12 - 10 AWG	8	0.38"	0.29"	0.73"	0.54"	0.040"	0.135"
13-10-W	054007-28738	12 - 10 AWG	10	0.38"	0.29"	0.73"	0.54"	0.040"	0.135"
13-14S-W	054007-28739	12 - 10 AWG	1/4"	0.54"	0.44"	0.96"	0.69"	0.040"	0.135"
13-14-W	054007-28740	12 - 10 AWG	1/4"	0.59"	0.44"	0.99"	0.69"	0.040"	0.135"
13-56S-W	054007-28741	12 - 10 AWG	5/16"	0.54"	0.44"	0.96"	0.69"	0.040"	0.135"
13-56-W	054007-28742	12 - 10 AWG	5/16"	0.59"	0.44"	0.99"	0.69"	0.040"	0.135"
13-38S-W	054007-28743	12 - 10 AWG	3/8"	0.54"	0.44"	0.96"	0.69"	0.040"	0.135"
13-38-W	054007-28744	12 - 10 AWG	3/8"	0.59"	0.44"	0.99"	0.69"	0.040"	0.135"
13-500-W	054007-28746	12 - 10 AWG	1/2"	0.75"	0.57"	1.19"	0.82"	0.040"	0.135"
14-10S-W	054007-29074	8 AWG	10	0.47"	0.40"	0.95"	0.72"	0.050"	0.175"



Specialty Wire Terminals, Kits and Tools

3M™ Terminals: 3M™ Ring Tongues

Non-Insulated Brazed Seam Ring Tongue (continued)

Product No.	UPC	Conductor Size	Stud Size	(W)	(C)	(L)	(E)	Thickness	Barrel I.D.
14-14S-W	054007-29076	8 AWG	1/4"	0.47"	0.40"	0.95"	0.72"	0.050"	0.175"
14-56-W	054007-29078	8 AWG	5/16"	0.59"	0.45"	1.06"	0.77"	0.050"	0.175"
14-38-W	054007-29079	8 AWG	3/8"	0.59"	0.45"	1.06"	0.77"	0.050"	0.175"
14-716S-W	054007-29080	8 AWG	7/16"	0.81"	0.69"	1.41"	1.00"	0.050"	0.175"
14-500-W	000000-00000	8 AWG	1/2"	0.81"	0.69"	1.41"	1.00"	0.050"	0.175"
14-500S-W	054007-29082	8 AWG	1/2"	0.81"	0.69"	1.41"	1.00"	0.050"	0.175"
15-10S-W	054007-29102	6 AWG	10	0.47"	0.52"	1.14"	0.91"	0.050"	0.250"
15-14S-W	054007-29104	6 AWG	1/4"	0.47"	0.52"	1.14"	0.91"	0.050"	0.250"
15-56-W	054007-29106	6 AWG	5/16"	0.63"	0.52"	1.22"	0.91"	0.050"	0.250"
15-38-W	054007-29107	6 AWG	3/8"	0.63"	0.52"	1.22"	0.91"	0.050"	0.250"
15-500S-W	054007-29110	6 AWG	1/2"	0.81"	0.63"	1.42"	1.02"	0.050"	0.250"
15-58-W	054007-29112	6 AWG	5/8"	1.13"	1.02"	1.97"	1.41"	0.050"	0.250"
16-10-W	054007-29130	4 AWG	10	0.68"	0.53"	1.34"	1.00"	0.075"	0.280"
16-14-W	054007-29131	4 AWG	1/4"	0.68"	0.53"	1.34"	1.00"	0.075"	0.280"
16-56-W	054007-29132	4 AWG	5/16"	0.68"	0.53"	1.34"	1.00"	0.075"	0.280"
16-38-W	054007-29133	4 AWG	3/8"	0.68"	0.53"	1.34"	1.00"	0.075"	0.280"
16-500S-W	054007-29136	4 AWG	1/2"	0.68"	0.53"	1.34"	1.00"	0.075"	0.280"

Vinyl Insulated Butted Seam Ring Tongue

Terminal Type Ring
 Terminal Style Standard
 Insulation Material Vinyl
 Barrel Style Butted
 RoHS 2011/65/EU Yes
 Agency Approval 
 Manufacturing Origin 

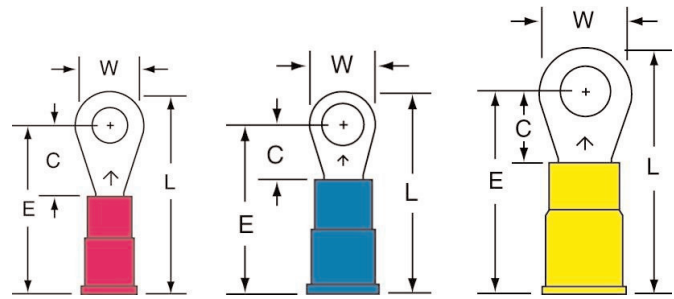

Product No.	UPC	Conductor Size	Stud Size	(W)	(C)	(L)	(E)	Thickness	Barrel I.D.	Max. Insul. Dia.
11-4S-P	054007-27894	22 - 18 AWG	4	0.25"	0.22"	0.80"	0.67"	0.030"	0.070"	0.145"
11-6S-P	054007-27896	22 - 18 AWG	6	0.25"	0.22"	0.80"	0.67"	0.030"	0.070"	0.145"
L-11-6-P	054007-27899	22 - 18 AWG	6	0.31"	0.33"	0.93"	0.78"	0.030"	0.070"	0.145"
11-8S-P	054007-27900	22 - 18 AWG	8	0.25"	0.22"	0.80"	0.67"	0.030"	0.070"	0.145"
11-8-P	054007-27901	22 - 18 AWG	8	0.33"	0.29"	0.90"	0.74"	0.030"	0.070"	0.145"
L-11-8-P	054007-27902	22 - 18 AWG	8	0.31"	0.33"	0.93"	0.78"	0.030"	0.070"	0.145"
11-10-P	054007-27903	22 - 18 AWG	10	0.33"	0.29"	0.90"	0.74"	0.030"	0.070"	0.145"
L-11-10-P	054007-27904	22 - 18 AWG	10	0.31"	0.33"	0.93"	0.78"	0.030"	0.070"	0.145"
11-14S-P	054007-27905	22 - 18 AWG	1/4"	0.47"	0.40"	1.08"	0.85"	0.030"	0.070"	0.145"
11-56S-P	054007-27907	22 - 18 AWG	5/16"	0.47"	0.40"	1.08"	0.85"	0.030"	0.070"	0.145"
11-38-P	054007-27909	22 - 18 AWG	3/8"	0.56"	0.40"	1.13"	0.85"	0.030"	0.070"	0.145"
12-4S-P	054007-28298	16 - 14 AWG	4	0.25"	0.22"	0.80"	0.67"	0.030"	0.070"	0.145"
12-6S-P	054007-28300	16 - 14 AWG	6	0.25"	0.22"	0.80"	0.67"	0.030"	0.070"	0.145"
12-6-P	054007-28301	16 - 14 AWG	6	0.33"	0.29"	0.90"	0.74"	0.030"	0.090"	0.170"
L-12-6-P	054007-28302	16 - 14 AWG	6	0.31"	0.33"	0.93"	0.78"	0.030"	0.090"	0.170"



Specialty Wire Terminals, Kits and Tools

3M™ Terminals: 3M™ Ring Tongues

Vinyl Insulated Butted Seam Ring Tongue (continued)

Product No.	UPC	Conductor Size	Stud Size	(W)	(C)	(L)	(E)	Thickness	Barrel I.D.	Max. Insul. Dia.
12-8-P	054007-28304	16 - 14 AWG	8	0.33"	0.29"	0.90"	0.74"	0.030"	0.070"	0.145"
L-12-8-P	054007-28305	16 - 14 AWG	8	0.31"	0.33"	0.93"	0.78"	0.030"	0.070"	0.145"
12-8S-P	054007-28303	16 - 14 AWG	8	0.25"	0.22"	0.80"	0.67"	0.030"	0.070"	0.145"
12-10-P	054007-28306	16 - 14 AWG	10	0.33"	0.29"	0.90"	0.74"	0.030"	0.070"	0.145"
L-12-10-P	054007-28307	16 - 14 AWG	10	0.31"	0.33"	0.93"	0.78"	0.030"	0.070"	0.145"
12-14S-P	054007-28308	16 - 14 AWG	1/4"	0.47"	0.40"	1.08"	0.85"	0.030"	0.070"	0.145"
12-14-P	054007-28309	16 - 14 AWG	1/4"	0.56"	0.40"	1.13"	0.85"	0.030"	0.090"	0.170"
12-56S-P	054007-28310	16 - 14 AWG	5/16"	0.47"	0.40"	1.08"	0.85"	0.030"	0.070"	0.145"
12-56-P	054007-28311	16 - 14 AWG	5/16"	0.56"	0.40"	1.13"	0.85"	0.030"	0.090"	0.170"
12-38-P	054007-28312	16 - 14 AWG	3/8"	0.56"	0.40"	1.13"	0.85"	0.030"	0.070"	0.145"
13-4S-P	054007-28705	12 - 10 AWG	4	0.28"	0.29"	0.98"	0.84"	0.040"	0.135"	0.250"
13-6S-P	054007-28706	12 - 10 AWG	6	0.28"	0.29"	0.98"	0.84"	0.040"	0.135"	0.250"
13-6-P	054007-28707	12 - 10 AWG	6	0.38"	0.29"	1.03"	0.84"	0.040"	0.135"	0.250"
13-8S-P	054007-28708	12 - 10 AWG	8	0.28"	0.29"	0.98"	0.84"	0.040"	0.135"	0.250"
13-8-P	054007-28709	12 - 10 AWG	8	0.38"	0.29"	1.03"	0.84"	0.040"	0.135"	0.250"
13-10-P	054007-28710	12 - 10 AWG	10	0.38"	0.29"	1.03"	0.84"	0.040"	0.135"	0.250"
13-14S-P	054007-28711	12 - 10 AWG	1/4"	0.53"	0.44"	1.26"	0.99"	0.040"	0.135"	0.250"
13-14-P	054007-28712	12 - 10 AWG	1/4"	0.59"	0.44"	1.29"	0.99"	0.040"	0.135"	0.250"
13-38S-P	054007-28715	12 - 10 AWG	3/8"	0.54"	0.44"	1.26"	0.99"	0.040"	0.135"	0.250"
13-56S-P	054007-28713	12 - 10 AWG	5/16"	0.53"	0.44"	1.26"	0.99"	0.040"	0.135"	0.250"
13-38-P	054007-28716	12 - 10 AWG	3/8"	0.59"	0.44"	1.29"	0.99"	0.040"	0.135"	0.250"
13-716-P	054007-28717	12 - 10 AWG	7/16"	0.75"	0.57"	1.49"	1.12"	0.040"	0.135"	0.250"
13-500-P	054007-28718	12 - 10 AWG	1/2"	0.75"	0.57"	1.50"	1.12"	0.040"	0.135"	0.250"

Nylon Insulated with Insulation Grip Ring Tongue

Terminal Type Ring
 Terminal Style Standard
 Insulation Material Nylon with Insulation Grip
 Barrel Style Butted
 RoHS 2011/65/EU Yes
 Agency Approval 
 Manufacturing Origin  With U.S. and Global Content

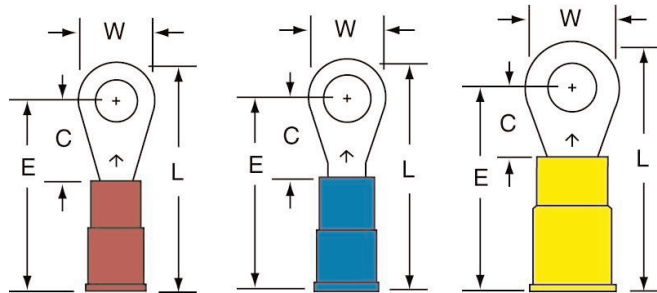

Product No.	UPC	Conductor Size	Stud Size	(W)	(C)	(L)	(E)	Thickness	Barrel I.D.	Max. Insul. Dia.
11-4S-NB	054007-27878	22 - 18 AWG	4	0.25"	0.22"	0.79"	0.66"	0.030"	0.070"	0.145"
11-6S-NB	054007-27880	22 - 18 AWG	6	0.25"	0.22"	0.79"	0.66"	0.030"	0.070"	0.145"
L-11-6-NB	054007-27882	22 - 18 AWG	6	0.31"	0.33"	0.92"	0.77"	0.030"	0.070"	0.145"
11-8S-NB	054007-27883	22 - 18 AWG	8	0.25"	0.22"	0.79"	0.66"	0.030"	0.070"	0.145"
11-8-NB	054007-27884	22 - 18 AWG	8	0.33"	0.29"	0.89"	0.73"	0.030"	0.070"	0.145"
L-11-8-NB	054007-27885	22 - 18 AWG	8	0.31"	0.33"	0.92"	0.77"	0.030"	0.070"	0.145"

Specialty Wire Terminals, Kits and Tools

3M™ Terminals: 3M™ Ring Tongues

Nylon Insulated with Insulation Grip Ring Tongue (continued)

Product No.	UPC	Conductor Size	Stud Size	(W)	(C)	(L)	(E)	Thickness	Barrel I.D.	Max. Insul. Dia.
11-10-NB	054007-27886	22 - 18 AWG	10	0.33"	0.29"	0.89"	0.73"	0.030"	0.070"	0.145"
L-11-10-NB	054007-27887	22 - 18 AWG	10	0.31"	0.33"	0.92"	0.77"	0.030"	0.070"	0.145"
11-14S-NB	054007-27888	22 - 18 AWG	1/4"	0.47"	0.40"	1.07"	0.84"	0.030"	0.070"	0.145"
11-56S-NB	054007-27890	22 - 18 AWG	5/16"	0.47"	0.40"	1.07"	0.84"	0.030"	0.070"	0.145"
11-38-NB	054007-27892	22 - 18 AWG	3/8"	0.56"	0.40"	1.12"	0.84"	0.030"	0.070"	0.145"
12-4S-NB	054007-28282	16 - 14 AWG	4	0.25"	0.22"	0.81"	0.68"	0.030"	0.090"	0.170"
12-6S-NB	054007-28284	16 - 14 AWG	6	0.25"	0.22"	0.81"	0.68"	0.030"	0.090"	0.170"
12-6-NB	054007-28285	16 - 14 AWG	6	0.33"	0.29"	0.91"	0.75"	0.030"	0.090"	0.170"
L-12-6-NB	054007-28286	16 - 14 AWG	6	0.31"	0.33"	0.94"	0.79"	0.030"	0.090"	0.170"
12-8-NB	054007-28288	16 - 14 AWG	8	0.33"	0.29"	0.91"	0.75"	0.030"	0.090"	0.170"
12-8S-NB	054007-28287	16 - 14 AWG	8	0.25"	0.22"	0.81"	0.68"	0.030"	0.090"	0.170"
L-12-8-NB	054007-28289	16 - 14 AWG	8	0.31"	0.33"	0.94"	0.79"	0.030"	0.090"	0.170"
12-10-NB	054007-28290	16 - 14 AWG	10	0.33"	0.29"	0.91"	0.75"	0.030"	0.090"	0.170"
L-12-10-NB	054007-28291	16 - 14 AWG	10	0.31"	0.33"	0.94"	0.79"	0.030"	0.090"	0.170"
12-14-NB	054007-28293	16 - 14 AWG	1/4"	0.56"	0.40"	1.14"	0.86"	0.030"	0.090"	0.170"
12-14S-NB	054007-28292	16 - 14 AWG	1/4"	0.47"	0.40"	1.09"	0.86"	0.030"	0.090"	0.170"
12-56S-NB	054007-28294	16 - 14 AWG	5/16"	0.47"	0.40"	1.09"	0.86"	0.030"	0.090"	0.170"
12-56-NB	054007-28295	16 - 14 AWG	5/16"	0.56"	0.40"	1.14"	0.86"	0.030"	0.090"	0.170"
12-38-NB	054007-28296	16 - 14 AWG	3/8"	0.56"	0.40"	1.14"	0.86"	0.030"	0.090"	0.170"
13-4S-NB	054007-28691	12 - 10 AWG	4	0.28"	0.29"	0.98"	0.84"	0.040"	0.135"	0.250"
13-6S-NB	054007-28692	12 - 10 AWG	6	0.28"	0.29"	0.98"	0.84"	0.040"	0.135"	0.250"
13-6-NB	054007-28693	12 - 10 AWG	6	0.38"	0.29"	1.03"	0.84"	0.040"	0.135"	0.250"
13-8S-NB	054007-28694	12 - 10 AWG	8	0.28"	0.29"	0.98"	0.84"	0.040"	0.135"	0.250"
13-8-NB	054007-28695	12 - 10 AWG	8	0.38"	0.29"	1.03"	0.84"	0.040"	0.135"	0.250"
13-10-NB	054007-28696	12 - 10 AWG	10	0.38"	0.29"	1.03"	0.84"	0.040"	0.135"	0.250"
13-14S-NB	054007-28697	12 - 10 AWG	1/4"	0.53"	0.44"	1.26"	0.99"	0.040"	0.135"	0.250"
13-14-NB	054007-28698	12 - 10 AWG	1/4"	0.59"	0.44"	1.29"	0.99"	0.040"	0.135"	0.250"
13-56S-NB	054007-28699	12 - 10 AWG	5/16"	0.53"	0.44"	1.26"	0.99"	0.040"	0.135"	0.250"
13-56-NB	054007-28700	12 - 10 AWG	5/16"	0.59"	0.44"	1.29"	0.99"	0.040"	0.135"	0.250"
13-38S-NB	054007-28701	12 - 10 AWG	3/8"	0.54"	0.44"	1.26"	0.99"	0.040"	0.135"	0.250"
13-38-NB	054007-28702	12 - 10 AWG	3/8"	0.59"	0.44"	1.29"	0.99"	0.040"	0.135"	0.250"
13-716-NB	054007-28703	12 - 10 AWG	7/16"	0.75"	0.57"	1.49"	1.12"	0.040"	0.135"	0.250"
13-500-NB	054007-28704	12 - 10 AWG	1/2"	0.75"	0.57"	1.50"	1.12"	0.040"	0.135"	0.250"

3M™ Terminals: 3M™ Ring Tongues

Nylon Insulated Brazed Seam Ring Tongue

Terminal Type Ring
 Terminal Style Standard
 Insulation Material Nylon
 Barrel Style Brazed
 RoHS 2011/65/EU Yes

Agency Approval 
 Except for 26 - 24 AWG Rings

Manufacturing Origin 

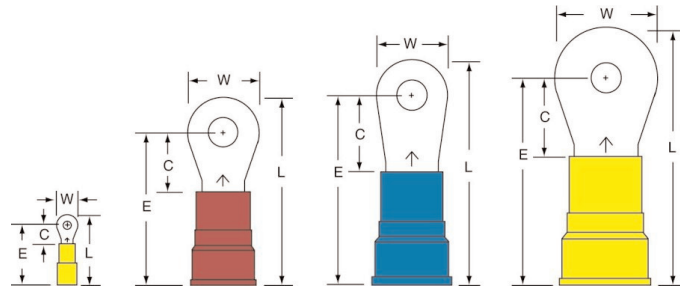

Product No.	UPC	Conductor Size	Stud Size	(W)	(C)	(L)	(E)	Thickness	Barrel I.D.	Max. Insul. Dia.
14-10S-WN	054007-08231	8 AWG	10	0.47"	0.40"	1.26"	1.03"	0.050"	0.175"	0.340"
14-14S-WN	054007-08233	8 AWG	1/4"	0.47"	0.40"	1.26"	1.03"	0.050"	0.175"	0.340"
14-56-WN	054007-08235	8 AWG	5/16"	0.59"	0.45"	1.38"	1.08"	0.050"	0.175"	0.340"
14-38-WN	054007-08236	8 AWG	3/8"	0.59"	0.45"	1.38"	1.08"	0.050"	0.175"	0.340"
14-500S-WN	054007-08239	8 AWG	1/2"	0.81"	0.69"	1.72"	1.32"	0.050"	0.175"	0.340"
15-10S-WN	054007-08243	6 AWG	10	0.47"	0.52"	1.50"	1.27"	0.050"	0.250"	0.440"
15-14S-WN	054007-08245	6 AWG	1/4"	0.47"	0.52"	1.50"	1.27"	0.050"	0.250"	0.440"
15-56-WN	054007-08247	6 AWG	5/16"	0.63"	0.52"	1.58"	1.27"	0.050"	0.250"	0.440"
15-38-WN	054007-08248	6 AWG	3/8"	0.63"	0.52"	1.58"	1.27"	0.050"	0.250"	0.440"
15-500S-WN	054007-08251	6 AWG	1/2"	0.81"	0.63"	1.78"	1.38"	0.050"	0.250"	0.440"
16-10-WN	054007-08255	4 AWG	10	0.68"	0.53"	1.74"	1.41"	0.075"	0.280"	0.515"
16-14-WN	054007-08256	4 AWG	1/4"	0.68"	0.53"	1.74"	1.41"	0.075"	0.280"	0.515"
16-56-WN	054007-08257	4 AWG	5/16"	0.68"	0.53"	1.74"	1.41"	0.075"	0.280"	0.515"
16-38-WN	054007-08258	4 AWG	3/8"	0.68"	0.53"	1.74"	1.41"	0.075"	0.280"	0.515"
16-716S-WN	054007-08259	4 AWG	7/16"	0.68"	0.53"	1.74"	1.41"	0.075"	0.280"	0.515"
16-500S-WN	054007-08261	4 AWG	1/2"	0.68"	0.53"	1.74"	1.41"	0.075"	0.280"	0.515"
10-2-WN	054007-95132	26 - 24 AWG	2	0.14"	0.12"	0.47"	0.40"	0.020"	0.030"	0.093"
10-4-WN	054007-95138	26 - 24 AWG	4	0.20"	0.21"	0.60"	0.49"	0.020"	0.030"	0.093"
10-6-WN	054007-95143	26 - 24 AWG	6	0.20"	0.21"	0.60"	0.49"	0.020"	0.030"	0.093"
10-8-WN	054007-95158	26 - 24 AWG	8	0.25"	0.28"	0.69"	0.56"	0.020"	0.030"	0.093"
10-10-WN	054007-95153	26 - 24 AWG	10	0.25"	0.28"	0.69"	0.56"	0.020"	0.030"	0.093"

Specialty Wire Terminals, Kits and Tools

3M™ Terminals: 3M™ Ring Tongues

Heat Shrink Brazed Seam Ring Tongue

Terminal Type	Ring
Terminal Style	Standard
Insulation Material	Heat Shrink
Barrel Style	Brazed
RoHS 2011/65/EU	Yes
Manufacturing Origin	

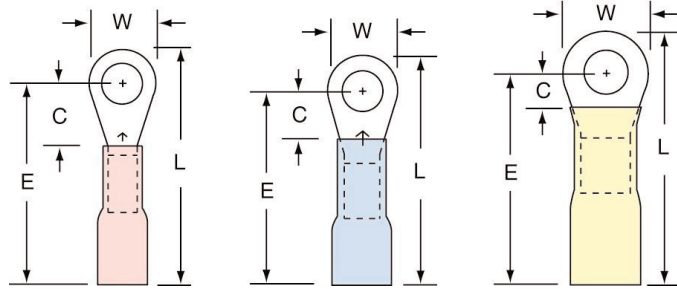

Product No.	UPC	Conductor Size	Stud Size	(W)	(C)	(L)	(E)	Thickness	Barrel I.D.	Terminals per Case
MH18-6R/LX	051128-58910	22 - 18 AWG	6	0.31"	0.15"	1.00"	0.84"	0.030"	0.070"	125
MH18-6R/LK	054007-06345	22 - 18 AWG	6	0.31"	0.15"	1.00"	0.84"	0.030"	0.070"	250
MH18-8R/LX	051128-58912	22 - 18 AWG	8	0.31"	0.18"	1.00"	0.84"	0.030"	0.070"	125
MH18-8R/LK	054007-06349	22 - 18 AWG	8	0.31"	0.18"	1.00"	0.84"	0.030"	0.070"	250
MH18-10R/LX	051128-58914	22 - 18 AWG	10	0.31"	0.20"	1.00"	0.84"	0.030"	0.070"	125
MH18-10R/LK	054007-06351	22 - 18 AWG	10	0.31"	0.20"	1.00"	0.84"	0.030"	0.070"	250
MH14-6R/LX	051128-58898	16 - 14 AWG	6	0.31"	0.15"	1.00"	0.84"	0.030"	0.090"	125
MH14-6R/LK	054007-06321	16 - 14 AWG	6	0.31"	0.15"	1.00"	0.84"	0.030"	0.090"	250
MH14-8R/LX	051128-58900	16 - 14 AWG	8	0.31"	0.18"	1.00"	0.84"	0.030"	0.090"	125
MH14-8R/LK	054007-06325	16 - 14 AWG	8	0.31"	0.18"	1.00"	0.84"	0.030"	0.090"	250
MH14-10R/LX	051128-58901	16 - 14 AWG	10	0.31"	0.20"	1.00"	0.84"	0.030"	0.090"	125
MH14-10R/LK	054007-06327	16 - 14 AWG	10	0.31"	0.20"	1.00"	0.84"	0.030"	0.090"	250
MH14-14R/SX	051128-58903	16 - 14 AWG	1/4"	0.47"	0.26"	1.10"	0.86"	0.030"	0.090"	125
MH14-14R/SK	054007-06331	16 - 14 AWG	1/4"	0.47"	0.26"	1.10"	0.86"	0.030"	0.090"	250
MH14-516R/SX	051128-58906	16 - 14 AWG	5/16"	0.47"	0.33"	1.10"	0.86"	0.030"	0.090"	125
MH14-516R/SK	054007-06337	16 - 14 AWG	5/16"	0.47"	0.33"	1.10"	0.86"	0.030"	0.090"	250
MH14-38RX	051128-58905	16 - 14 AWG	3/8"	0.56"	0.28"	1.10"	0.87"	0.030"	0.090"	125
MH14-38RK	054007-06335	16 - 14 AWG	3/8"	0.56"	0.28"	1.10"	0.87"	0.030"	0.090"	250
MH10-8RX	051128-58888	12 - 10 AWG	8	0.38"	0.19"	1.10"	0.91"	0.040"	0.145"	125
MH10-8RK	054007-06303	12 - 10 AWG	8	0.38"	0.19"	1.10"	0.91"	0.040"	0.145"	250
MH10-10RX	051128-58890	12 - 10 AWG	10	0.38"	0.21"	1.10"	0.90"	0.040"	0.145"	125
MH10-10RK	054007-06306	12 - 10 AWG	10	0.38"	0.21"	1.10"	0.90"	0.040"	0.145"	250
MH10-14RX	051128-58892	12 - 10 AWG	1/4"	0.59"	0.29"	1.20"	0.90"	0.040"	0.145"	125
MH10-14RK	054007-06359	12 - 10 AWG	1/4"	0.59"	0.29"	1.20"	0.90"	0.040"	0.145"	250
MH10-38RX	051128-58894	12 - 10 AWG	3/8"	0.59"	0.29"	1.20"	0.90"	0.040"	0.145"	125
MH10-38RK	054007-06313	12 - 10 AWG	3/8"	0.59"	0.29"	1.20"	0.90"	0.040"	0.145"	250

Specialty Wire Terminals, Kits and Tools

3M™ Terminals: 3M™ Ring Tongues

Heavy-Duty Nylon Insulated with Insulation Grip Ring Tongue

Terminal Type Ring
 Terminal Style Standard
 Insulation Material Nylon with Insulation Grip
 Barrel Style Butted
 RoHS 2011/65/EU Yes

Agency Approval  

Manufacturing Origin  With U.S. and Global Content

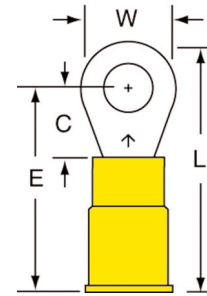

Product No.	UPC	Conductor Size	Stud Size	(W)	(C)	(L)	(E)	Thickness	Barrel I.D.	Max. Insul. Dia.
123-6S-NB	054007-28901	16 - 12 AWG	6	0.28"	0.29"	0.98"	0.84"	0.050"	0.110"	0.250"
123-8S-NB	054007-28903	16 - 12 AWG	8	0.28"	0.29"	0.98"	0.84"	0.050"	0.110"	0.250"
123-10-NB	054007-28905	16 - 12 AWG	10	0.38"	0.29"	1.03"	0.84"	0.050"	0.110"	0.250"
123-14-NB	054007-28907	16 - 12 AWG	1/4"	0.61"	0.44"	1.29"	0.99"	0.050"	0.110"	0.250"
123-56-NB	054007-28909	16 - 12 AWG	5/16"	0.61"	0.44"	1.29"	0.99"	0.050"	0.110"	0.250"
123-38-NB	054007-28911	16 - 12 AWG	3/8"	0.61"	0.44"	1.29"	0.99"	0.050"	0.110"	0.250"
123-716-NB	054007-28912	16 - 12 AWG	7/16"	0.75"	0.57"	1.49"	1.12"	0.050"	0.110"	0.250"
123-500-NB	054007-28913	16 - 12 AWG	1/2"	0.75"	0.57"	1.50"	1.12"	0.050"	0.110"	0.250"

Heavy-Duty Non-Insulated Butted Seam Ring Tongue

Terminal Type Ring
 Terminal Style Standard
 Insulation Material Nylon with Insulation Grip
 Barrel Style Butted
 RoHS 2011/65/EU Yes

Agency Approval  

Manufacturing Origin 

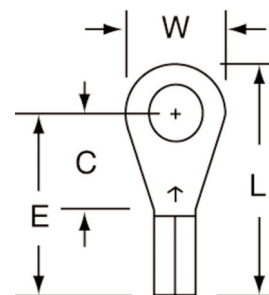

Product No.	UPC	Conductor Size	Stud Size	(W)	(C)	(L)	(E)	Thickness	Barrel I.D.
123-8	054007-28932	16 - 12 AWG	8	0.38"	0.29"	0.73"	0.54"	0.050"	0.110"
123-10	054007-28933	16 - 12 AWG	10	0.38"	0.29"	0.73"	0.54"	0.050"	0.110"
123-14	054007-28935	16 - 12 AWG	1/4"	0.61"	0.44"	0.99"	0.69"	0.050"	0.110"
123-56	054007-28937	16 - 12 AWG	5/16"	0.61"	0.44"	0.99"	0.69"	0.050"	0.110"
123-38	054007-28939	16 - 12 AWG	3/8"	0.61"	0.44"	0.99"	0.69"	0.050"	0.110"

Specialty Wire Terminals, Kits and Tools

3M™ Terminals: 3M™ Hook Tongues

Non-Insulated Butted Seam Hook Tongue

Terminal Type Hook
 Terminal Style Standard
 Insulation Material Non-Insulated
 Barrel Style Butted
 RoHS 2011/65/EU Yes

Agency Approval 

Manufacturing Origin 

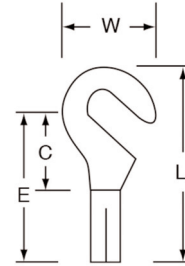

Product No.	UPC	Conductor Size	Stud Size	(W)	(C)	(L)	(E)	Thickness	Barrel I.D.
41-8	054007-28236	22 - 18 AWG	8	0.33"	0.29"	0.70"	0.54"	0.030"	0.070"
42-8	054007-28635	16 - 14 AWG	8	0.33"	0.29"	0.70"	0.54"	0.030"	0.090"
42-10	054007-28636	16 - 14 AWG	10	0.33"	0.29"	0.70"	0.54"	0.030"	0.090"
43-8	054007-28858	12 - 10 AWG	8	0.38"	0.29"	0.73"	0.54"	0.040"	0.135"
43-10	054007-28859	12 - 10 AWG	10	0.38"	0.29"	0.73"	0.54"	0.040"	0.135"

Vinyl Insulated Butted Seam Hook Tongue

Terminal Type Hook
 Terminal Style Standard
 Insulation Material Vinyl
 Barrel Style Butted
 RoHS 2011/65/EU Yes

Agency Approval 

Manufacturing Origin 

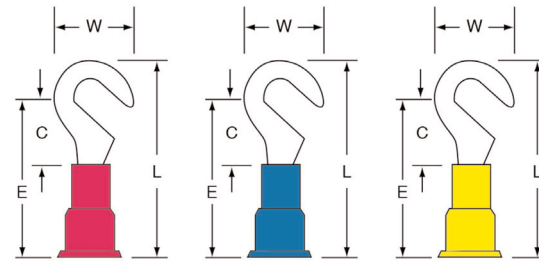



Product No.	UPC	Conductor Size	Stud Size	(W)	(C)	(L)	(E)	Thickness	Barrel I.D.
41-8-P	054007-28233	22 - 18 AWG	8	0.33"	0.29"	0.90"	0.74"	0.030"	0.070"
41-10-P	054007-28234	22 - 18 AWG	10	0.33"	0.29"	0.90"	0.74"	0.030"	0.070"
42-6-P	054007-28631	16 - 14 AWG	6	0.33"	0.29"	0.90"	0.74"	0.030"	0.090"
42-8-P	054007-28632	16 - 14 AWG	8	0.33"	0.29"	0.90"	0.74"	0.030"	0.090"
42-10-P	054007-28633	16 - 14 AWG	10	0.33"	0.29"	0.90"	0.74"	0.030"	0.090"
43-8-P	054007-28855	12 - 10 AWG	8	0.38"	0.29"	1.03"	0.84"	0.040"	0.135"
43-10-P	054007-28856	12 - 10 AWG	10	0.38"	0.29"	1.03"	0.84"	0.040"	0.135"

Specialty Wire Terminals, Kits and Tools

3M™ Terminals: 3M™ Hook Tongues

Nylon Insulated with Insulation Grip Hook Tongue

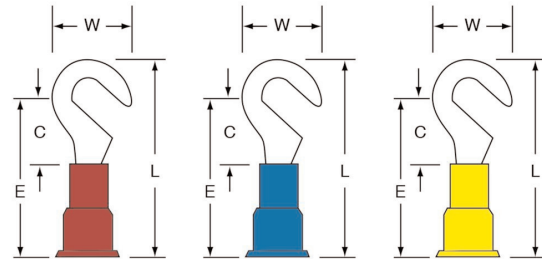

Terminal Type Hook
Terminal Style Standard
Insulation Material Nylon with Insulation Grip
Barrel Style Butted
RoHS 2011/65/EU Yes
Agency Approval 
Manufacturing Origin 



Product No.	UPC	Conductor Size	Stud Size	(W)	(C)	(L)	(E)	Thickness	Barrel I.D.
41-6-NB	054007-28229	22 - 18 AWG	6	0.33"	0.29"	0.90"	0.73"	0.030"	0.070"
41-8-NB	054007-28230	22 - 18 AWG	8	0.33"	0.29"	0.90"	0.73"	0.030"	0.070"
41-10-NB	054007-28231	22 - 18 AWG	10	0.33"	0.29"	0.90"	0.73"	0.030"	0.070"
42-6-NB	054007-28628	16 - 14 AWG	6	0.33"	0.29"	0.92"	0.75"	0.030"	0.090"
42-8-NB	054007-28629	16 - 14 AWG	8	0.33"	0.29"	0.92"	0.75"	0.030"	0.090"
42-10-NB	054007-28630	16 - 14 AWG	10	0.33"	0.29"	0.92"	0.75"	0.030"	0.090"
43-6-NB	054007-28851	12 - 10 AWG	6	0.38"	0.29"	1.03"	0.89"	0.040"	0.135"
43-8-NB	054007-28852	12 - 10 AWG	8	0.38"	0.29"	1.03"	0.89"	0.040"	0.135"
43-10-NB	054007-28853	12 - 10 AWG	10	0.38"	0.29"	1.03"	0.89"	0.040"	0.135"

3M™ Terminals: 3M™ Multi-Stud Ring Tongues

Non-Insulated Butted Seam Multi-Stud Ring Tongue

Terminal Type Ring
Terminal Style Multi-Stud
Insulation Material Non-Insulated
Barrel Style Butted
RoHS 2011/65/EU Yes
Agency Approval 
Manufacturing Origin 

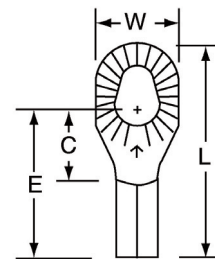



Product No.	UPC	Conductor Size	Stud Size	(W)	(C)	(L)	(E)	Thickness	Barrel I.D.
12-610	054007-29642	16 - 14 AWG	6, 8, 10	0.34"	0.31"	0.81"	0.56"	0.030"	0.090"
13-610	054007-29646	12 - 10 AWG	6, 8, 10	0.39"	0.35"	0.89"	0.60"	0.040"	0.135"

Specialty Wire Terminals, Kits and Tools

3M™ Terminals: 3M™ Multi-Stud Ring Tongues

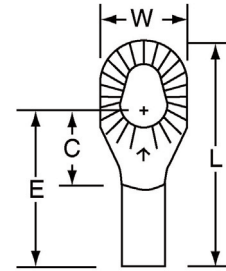

Non-Insulated Brazed Seam Multi-Stud Ring Tongue

Terminal Type Ring
 Terminal Style Multi-Stud
 Insulation Material Non-Insulated
 Barrel Style Butted
 RoHS 2011/65/EU Yes
 Agency Approval 
 Manufacturing Origin 



Product No.	UPC	Conductor Size	Stud Size	(W)	(C)	(L)	(E)	Thickness	Barrel I.D.
11-610-W	054007-29639	22 - 18 AWG	6, 8, 10	0.34"	0.31"	0.81"	0.56"	0.030"	0.070"
12-610-W	054007-29670	16 - 14 AWG	6, 8, 10	0.34"	0.31"	0.81"	0.56"	0.030"	0.090"
13-610-W	054007-29647	12 - 10 AWG	6, 8, 10	0.39"	0.35"	0.89"	0.60"	0.040"	0.135"

Vinyl Insulated Butted Seam Multi-Stud Ring Tongue

Terminal Type Ring
 Terminal Style Multi-Stud
 Insulation Material Vinyl
 Barrel Style Butted
 RoHS 2011/65/EU Yes
 Agency Approval 
 Manufacturing Origin 

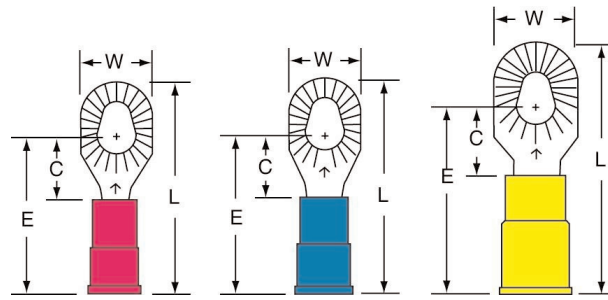

Product No.	UPC	Conductor Size	Stud Size	(W)	(C)	(L)	(E)	Thickness	Barrel I.D.	Max. Insul. Dia.
11-610-P	054007-29640	22 - 18 AWG	6, 8, 10	0.34"	0.31"	1.01"	0.76"	0.030"	0.070"	0.145"
12-26-P	054007-29898	16 - 14 AWG	2, 4, 6	0.28"	0.28"	0.94"	0.73"	0.030"	0.090"	0.170"
12-610-P	054007-29643	16 - 14 AWG	6, 8, 10	0.34"	0.31"	1.01"	0.76"	0.030"	0.090"	0.170"
13-610-P	054007-29648	12 - 10 AWG	6, 8, 10	0.39"	0.35"	1.19"	0.80"	0.040"	0.135"	0.250"

Specialty Wire Terminals, Kits and Tools

3M™ Terminals: 3M™ Multi-Stud Ring Tongues

Nylon Insulated with Insulation Grip Multi-Stud Ring Tongue

Terminal Type Ring
 Terminal Style Multi-Stud
 Insulation Material Nylon with Insulation Grip
 Barrel Style Butted
 RoHS 2011/65/EU Yes

Agency Approval 

Manufacturing Origin 

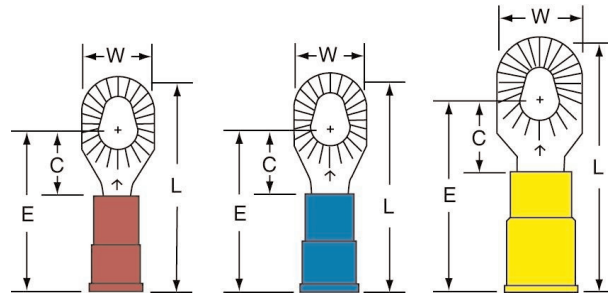



Product No.	UPC	Conductor Size	Stud Size	(W)	(C)	(L)	(E)	Thickness	Barrel I.D.	Max. Insul. Dia.
11-26-NB	054007-29901	22 - 18 AWG	2, 4, 6	0.28"	0.28"	0.93"	0.72"	0.030"	0.070"	0.145"
11-610-NB	054007-29641	22 - 18 AWG	6, 8, 10	0.34"	0.31"	1.00"	0.75"	0.030"	0.070"	0.145"
12-26-NB	054007-29902	16 - 14 AWG	2, 4, 6	0.28"	0.28"	0.95"	0.74"	0.030"	0.090"	0.170"
12-610-NB	054007-29644	16 - 14 AWG	6, 8, 10	0.34"	0.31"	1.02"	0.77"	0.030"	0.090"	0.170"
13-610-NB	054007-29649	12 - 10 AWG	6, 8, 10	0.39"	0.35"	1.19"	0.80"	0.040"	0.135"	0.250"

3M™ Terminals: 3M™ Standard Forks

Non-Insulated Butted Seam Standard Fork

Terminal Type Fork
 Terminal Style Standard
 Insulation Material Non-Insulated
 Barrel Style Butted
 RoHS 2011/65/EU Yes

Agency Approval 

Manufacturing Origin 

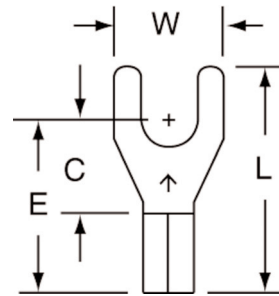



Product No.	UPC	Conductor Size	Stud Size	(W)	(C)	(L)	(E)	Thickness	Barrel I.D.
32-10	054007-28451	16 - 14 AWG	10	0.34"	0.29"	0.70"	0.54"	0.030"	0.090"
33-8	054007-28774	12 - 10 AWG	8	0.38"	0.29"	0.73"	0.54"	0.040"	0.135"
33-10	054007-28775	12 - 10 AWG	10	0.38"	0.29"	0.73"	0.54"	0.040"	0.135"

Specialty Wire Terminals, Kits and Tools

3M™ Terminals: 3M™ Standard Forks

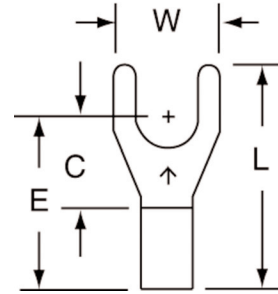

Non-Insulated Brazed Seam Standard Fork

Terminal Type Fork
 Terminal Style Standard
 Insulation Material Non-Insulated
 Barrel Style Brazed
 RoHS 2011/65/EU Yes
 Agency Approval 
 Manufacturing Origin 



Product No.	UPC	Conductor Size	Stud Size	(W)	(C)	(L)	(E)	Thickness	Barrel I.D.
31-6-W	054007-28056	22 - 18 AWG	6	0.34"	0.29"	0.70"	0.54"	0.030"	0.070"
31-8-W	054007-28058	22 - 18 AWG	8	0.34"	0.29"	0.70"	0.54"	0.030"	0.070"
31-10-W	054007-28060	22 - 18 AWG	10	0.34"	0.29"	0.70"	0.54"	0.030"	0.070"
32-6-W	054007-28453	16 - 14 AWG	6	0.34"	0.29"	0.70"	0.54"	0.030"	0.090"
32-8-W	054007-28455	16 - 14 AWG	8	0.34"	0.29"	0.70"	0.54"	0.030"	0.090"
32-10-W	054007-28457	16 - 14 AWG	10	0.34"	0.29"	0.70"	0.54"	0.030"	0.090"
33-6-W	054007-28776	12 - 10 AWG	6	0.38"	0.29"	0.73"	0.54"	0.040"	0.135"
33-8-W	054007-28777	12 - 10 AWG	8	0.38"	0.29"	0.73"	0.54"	0.040"	0.135"
33-10-W	054007-28778	12 - 10 AWG	10	0.38"	0.29"	0.73"	0.54"	0.040"	0.135"

Vinyl Insulated Butted Seam Standard Fork

Terminal Type Fork
 Terminal Style Standard
 Insulation Material Vinyl
 Barrel Style Butted
 RoHS 2011/65/EU Yes
 Agency Approval 
 Manufacturing Origin 

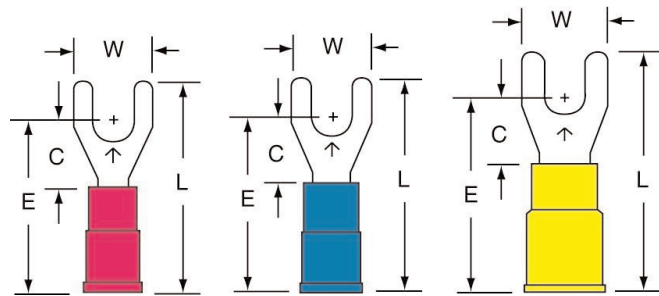



Product No.	UPC	Conductor Size	Stud Size	(W)	(C)	(L)	(E)	Thickness	Barrel I.D.	Max. Insul. Dia.
31-6-P	054007-28044	22 - 18 AWG	6	0.34"	0.29"	0.90"	0.74"	0.030"	0.070"	0.145"
31-8-P	054007-28046	22 - 18 AWG	8	0.34"	0.29"	0.90"	0.74"	0.030"	0.070"	0.145"
31-10-P	054007-28048	22 - 18 AWG	10	0.34"	0.29"	0.90"	0.74"	0.030"	0.070"	0.145"
32-6-P	054007-28441	16 - 14 AWG	6	0.34"	0.29"	0.90"	0.74"	0.030"	0.090"	0.170"
32-8-P	054007-28443	16 - 14 AWG	8	0.34"	0.29"	0.90"	0.74"	0.030"	0.090"	0.170"
32-10-P	054007-28445	16 - 14 AWG	10	0.34"	0.29"	0.90"	0.74"	0.030"	0.090"	0.170"
33-6-P	054007-28770	12 - 10 AWG	6	0.38"	0.29"	1.03"	0.84"	0.030"	0.135"	0.250"
33-8-P	054007-28771	12 - 10 AWG	8	0.38"	0.29"	1.03"	0.84"	0.030"	0.135"	0.250"
33-10-P	054007-28772	12 - 10 AWG	10	0.38"	0.29"	1.03"	0.84"	0.030"	0.135"	0.250"

Specialty Wire Terminals, Kits and Tools

3M™ Terminals: 3M™ Standard Forks

Nylon Insulated with Insulation Grip Standard Fork

Terminal Type Fork
 Terminal Style Standard
 Insulation Material Nylon with Insulation Grip
 Barrel Style Butted
 RoHS 2011/65/EU Yes

Agency Approval  

Manufacturing Origin  With U.S. and Global Content

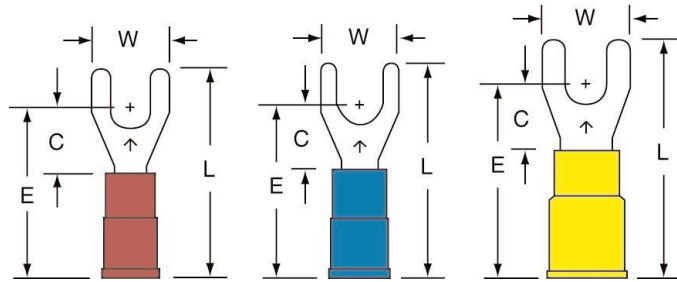

Product No.	UPC	Conductor Size	Stud Size	(W)	(C)	(L)	(E)	Thickness	Barrel I.D.	Max. Insul. Dia.
31-6-NB	054007-28038	22 - 18 AWG	6	0.34"	0.29"	0.89"	0.73"	0.030"	0.070"	0.145"
31-8-NB	054007-28040	22 - 18 AWG	8	0.34"	0.29"	0.89"	0.73"	0.030"	0.070"	0.145"
31-10-NB	054007-28042	22 - 18 AWG	10	0.34"	0.29"	0.89"	0.73"	0.030"	0.070"	0.145"
32-6-NB	054007-28435	16 - 14 AWG	6	0.34"	0.29"	0.91"	0.75"	0.030"	0.070"	0.145"
32-8-NB	054007-28437	16 - 14 AWG	8	0.34"	0.29"	0.91"	0.75"	0.030"	0.070"	0.145"
32-10-NB	054007-28439	16 - 14 AWG	10	0.34"	0.29"	0.91"	0.75"	0.030"	0.070"	0.145"
33-6-NB	054007-28767	12 - 10 AWG	6	0.38"	0.29"	1.03"	0.84"	0.040"	0.135"	0.250"
33-8-NB	054007-28768	12 - 10 AWG	8	0.38"	0.29"	1.03"	0.84"	0.040"	0.135"	0.250"
33-10-NB	054007-28769	12 - 10 AWG	10	0.38"	0.29"	1.03"	0.84"	0.040"	0.135"	0.250"

Nylon Insulated Brazed Seam Standard Fork

Terminal Type Fork
 Terminal Style Standard
 Insulation Material Nylon
 Barrel Style Brazed
 RoHS 2011/65/EU Yes

Manufacturing Origin 

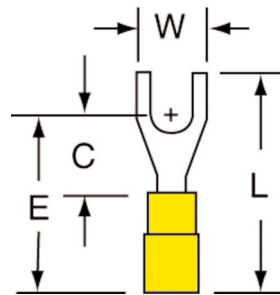



Product No.	UPC	Conductor Size	Stud Size	(W)	(L)	(E)	Thickness	Barrel I.D.	Max. Insul. Dia.
30-2-WN	054007-95177	26 - 24 AWG	2	0.20"	0.55"	0.47"	0.20"	0.040"	0.90"
30-4-WN	054007-95162	26 - 24 AWG	4	0.20"	0.56"	0.47"	0.20"	0.040"	0.90"
30-6-WN	054007-95168	26 - 24 AWG	6	0.24"	0.68"	0.59"	0.20"	0.040"	0.90"

Specialty Wire Terminals, Kits and Tools

3M™ Terminals: 3M™ Block Forks

Non-Insulated Butted Seam Block Fork

Terminal Type Fork
 Terminal Style Block
 Insulation Material Non-Insulated
 Barrel Style Butted
 RoHS 2011/65/EU Yes

Agency Approval  

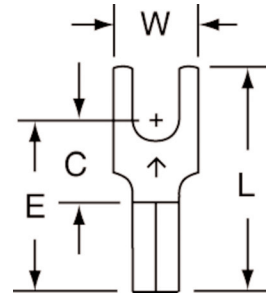

Manufacturing Origin 



Product No.	UPC	Conductor Size	Stud Size	(W)	(C)	(L)	(E)	Thickness	Barrel I.D.
BS-31-4S	054007-29632	22 - 18 AWG	4	0.25"	0.25"	0.65"	0.50"	0.030"	0.070"
BS-31-6S	054007-28142	22 - 18 AWG	6	0.25"	0.25"	0.65"	0.50"	0.030"	0.070"
BS-31-6	054007-28143	22 - 18 AWG	6	0.30"	0.25"	0.65"	0.50"	0.030"	0.070"
BS-31-8	054007-28144	22 - 18 AWG	8	0.30"	0.25"	0.65"	0.50"	0.030"	0.070"
BS-31-10	054007-28145	22 - 18 AWG	10	0.30"	0.25"	0.65"	0.50"	0.030"	0.070"
BS-32-6S	054007-28541	16 - 14 AWG	6	0.25"	0.25"	0.65"	0.50"	0.030"	0.090"
BS-32-6	054007-28542	16 - 14 AWG	6	0.30"	0.25"	0.65"	0.50"	0.030"	0.090"
BS-32-8	054007-28543	16 - 14 AWG	8	0.30"	0.25"	0.65"	0.50"	0.030"	0.090"
BS-32-10	054007-28544	16 - 14 AWG	10	0.30"	0.25"	0.65"	0.50"	0.030"	0.090"
BS-33-8	054007-28816	12 - 10 AWG	8	0.32"	0.29"	0.73"	0.54"	0.040"	0.135"
BS-33-10	054007-28817	12 - 10 AWG	10	0.32"	0.29"	0.73"	0.54"	0.040"	0.135"

Non-Insulated Brazed Seam Block Fork

Terminal Type Fork
 Terminal Style Block
 Insulation Material Non-Insulated
 Barrel Style Brazed
 RoHS 2011/65/EU Yes

Agency Approval  

Manufacturing Origin 

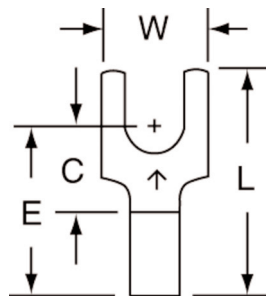

Product No.	UPC	Conductor Size	Stud Size	(W)	(C)	(L)	(E)	Thickness	Barrel I.D.
BS-31-6S-W	054007-28146	22 - 18 AWG	6	0.25"	0.25"	0.65"	0.50"	0.030"	0.070"
BS-31-6-W	054007-28147	22 - 18 AWG	6	0.30"	0.25"	0.65"	0.50"	0.030"	0.070"
BS-31-8-W	054007-28148	22 - 18 AWG	8	0.30"	0.25"	0.65"	0.50"	0.030"	0.070"
BS-31-10-W	054007-28149	22 - 18 AWG	10	0.30"	0.25"	0.65"	0.50"	0.030"	0.070"
BS-32-6S-W	054007-28545	16 - 14 AWG	6	0.25"	0.25"	0.65"	0.50"	0.030"	0.090"
BS-32-6-W	054007-28546	16 - 14 AWG	6	0.30"	0.25"	0.65"	0.50"	0.030"	0.090"
BS-32-8-W	054007-28547	16 - 14 AWG	8	0.30"	0.25"	0.65"	0.50"	0.030"	0.090"
BS-32-10-W	054007-28548	16 - 14 AWG	10	0.30"	0.25"	0.65"	0.50"	0.030"	0.090"
BS-33-6-W	054007-28818	12 - 10 AWG	6	0.32"	0.29"	0.73"	0.54"	0.040"	0.135"



Specialty Wire Terminals, Kits and Tools

3M™ Terminals: 3M™ Block Forks

Non-Insulated Brazed Seam Block Fork (continued)

Product No.	UPC	Conductor Size	Stud Size	(W)	(C)	(L)	(E)	Thickness	Barrel I.D.
BS-33-8-W	054007-28819	12 - 10 AWG	8	0.32"	0.29"	0.73"	0.54"	0.040"	0.135"
BS-33-10-W	054007-28820	12 - 10 AWG	10	0.32"	0.29"	0.73"	0.54"	0.040"	0.135"

Vinyl Insulated Butted Seam Block Fork

Terminal Type Fork
Terminal Style Block
Insulation Material Vinyl
Barrel Style Butted
RoHS 2011/65/EU Yes
Agency Approval 
Manufacturing Origin 

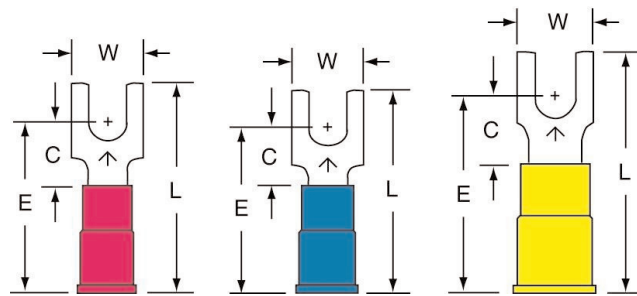



Product No.	UPC	Conductor Size	Stud Size	(W)	(C)	(L)	(E)	Thickness	Barrel I.D.	Max. Insul. Dia.
BS-31-4S-P	054007-29633	22 - 18 AWG	4	0.25"	0.25"	0.85"	0.70"	0.030"	0.070"	0.145"
BS-31-6S-P	054007-28138	22 - 18 AWG	6	0.25"	0.25"	0.85"	0.70"	0.030"	0.070"	0.145"
BS-31-6-P	054007-95351	22 - 18 AWG	6	0.30"	0.25"	0.85"	0.70"	0.030"	0.070"	0.145"
BS-31-8-P	054007-95352	22 - 18 AWG	8	0.30"	0.25"	0.85"	0.70"	0.030"	0.070"	0.145"
BS-31-10-P	054007-28141	22 - 18 AWG	10	0.30"	0.25"	0.85"	0.70"	0.030"	0.070"	0.145"
BS-32-4S-P	054007-30084	16 - 14 AWG	4	0.25"	0.25"	0.85"	0.70"	0.030"	0.090"	0.170"
BS-32-6S-P	054007-28537	16 - 14 AWG	6	0.25"	0.25"	0.85"	0.70"	0.030"	0.090"	0.170"
BS-32-6-P	054007-28538	16 - 14 AWG	6	0.30"	0.25"	0.85"	0.70"	0.030"	0.090"	0.170"
BS-32-8-P	054007-28539	16 - 14 AWG	8	0.30"	0.25"	0.85"	0.70"	0.030"	0.090"	0.170"
BS-32-10-P	054007-28540	16 - 14 AWG	10	0.30"	0.25"	0.85"	0.70"	0.030"	0.090"	0.170"
BS-33-6-P	054007-28812	12 - 10 AWG	6	0.32"	0.29"	1.03"	0.84"	0.040"	0.135"	0.250"
BS-33-8-P	054007-28813	12 - 10 AWG	8	0.32"	0.29"	1.03"	0.84"	0.040"	0.135"	0.250"
BS-33-10-P	054007-28814	12 - 10 AWG	10	0.32"	0.29"	1.03"	0.84"	0.040"	0.135"	0.250"

Specialty Wire Terminals, Kits and Tools

3M™ Terminals: 3M™ Block Forks

Nylon Insulated with Insulation Grip Block Fork

Terminal Type Fork
 Terminal Style Block
 Insulation Material Nylon with Insulation Grip
 Barrel Style Butted
 RoHS 2011/65/EU Yes

Agency Approval  

Manufacturing Origin  With U.S. and Global Content

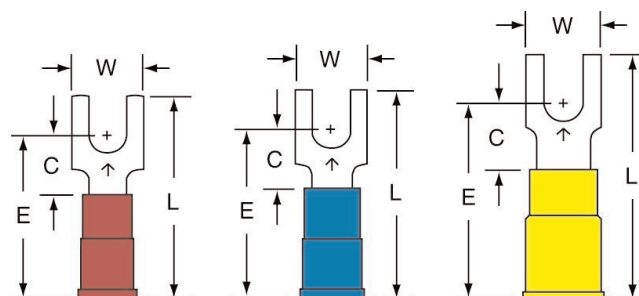



Product No.	UPC	Conductor Size	Stud Size	(W)	(C)	(L)	(E)	Thickness	Barrel I.D.	Max. Insul. Dia.
BS-31-4S-NB	054007-29634	22 - 18 AWG	4	0.25"	0.25"	0.84"	0.69"	0.030"	0.070"	0.145"
BS-31-6S-NB	054007-28134	22 - 18 AWG	6	0.25"	0.25"	0.84"	0.69"	0.030"	0.070"	0.145"
BS-31-6-NB	054007-28135	22 - 18 AWG	6	0.30"	0.25"	0.84"	0.69"	0.030"	0.070"	0.145"
BS-31-8-NB	054007-28136	22 - 18 AWG	8	0.30"	0.25"	0.84"	0.69"	0.030"	0.070"	0.145"
BS-31-10-NB	054007-28137	22 - 18 AWG	10	0.30"	0.25"	0.84"	0.69"	0.030"	0.070"	0.145"
BS-32-4S-NB	054007-30083	16 - 14 AWG	4	0.25"	0.25"	0.86"	0.71"	0.030"	0.090"	0.170"
BS-32-6S-NB	054007-28533	16 - 14 AWG	6	0.25"	0.25"	0.86"	0.71"	0.030"	0.090"	0.170"
BS-32-6-NB	054007-28534	16 - 14 AWG	6	0.30"	0.25"	0.86"	0.71"	0.030"	0.090"	0.170"
BS-32-8-NB	054007-28535	16 - 14 AWG	8	0.30"	0.25"	0.86"	0.71"	0.030"	0.090"	0.170"
BS-32-10-NB	054007-28536	16 - 14 AWG	10	0.30"	0.25"	0.86"	0.71"	0.030"	0.090"	0.170"
BS-33-6-NB	054007-28809	12 - 10 AWG	6	0.32"	0.29"	1.03"	0.84"	0.040"	0.135"	0.250"
BS-33-8-NB	054007-28810	12 - 10 AWG	8	0.32"	0.29"	1.03"	0.84"	0.040"	0.135"	0.250"
BS-33-10-NB	054007-28811	12 - 10 AWG	10	0.32"	0.29"	1.03"	0.84"	0.040"	0.135"	0.250"

Specialty Wire Terminals, Kits and Tools

3M™ Terminals: 3M™ Flanged Block Forks

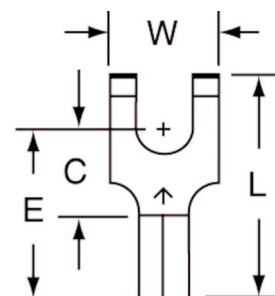

Non-Insulated Butted Seam Flanged Block Fork

Terminal Type Fork
Terminal Style Flanged Block
Insulation Material Non-Insulated
Barrel Style Butted
RoHS 2011/65/EU Yes
Agency Approval 
Manufacturing Origin 



Product No.	UPC	Conductor Size	Stud Size	(W)	(C)	(L)	(E)	Thickness	Barrel I.D.
BS-21-6	054007-28191	22 - 18 AWG	6	0.30"	0.25"	0.65"	0.50"	0.030"	0.070"
BS-21-8	054007-28192	22 - 18 AWG	8	0.30"	0.25"	0.65"	0.50"	0.030"	0.070"
BS-22-6	054007-28590	16 - 14 AWG	6	0.30"	0.25"	0.65"	0.50"	0.030"	0.090"
BS-22-10	054007-28592	16 - 14 AWG	10	0.30"	0.25"	0.65"	0.50"	0.030"	0.090"
BS-23-10	054007-28838	12 - 10 AWG	10	0.32"	0.29"	0.73"	0.54"	0.040"	0.135"

Non-Insulated Brazed Seam Flanged Block Fork

Terminal Type Fork
Terminal Style Flanged Block
Insulation Material Non-Insulated
Barrel Style Brazed
RoHS 2011/65/EU Yes
Agency Approval 
Manufacturing Origin 

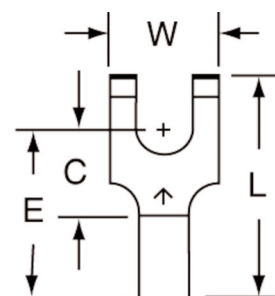



Product No.	UPC	Conductor Size	Stud Size	(W)	(C)	(L)	(E)	Thickness	Barrel I.D.
BS-21-10-W	054007-28197	22 - 18 AWG	10	0.30"	0.25"	0.65"	0.50"	0.030"	0.070"
BS-23-10-W	054007-28841	12 - 10 AWG	10	0.32"	0.29"	0.73"	0.54"	0.040"	0.135"

Specialty Wire Terminals, Kits and Tools

3M™ Terminals: 3M™ Flanged Block Forks

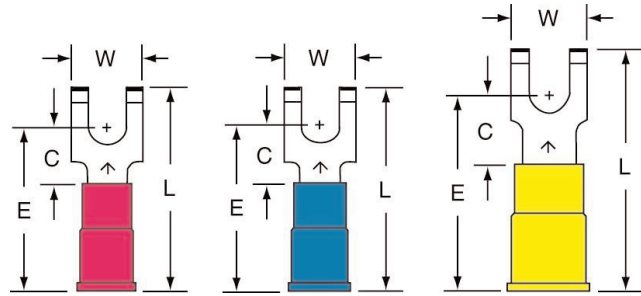

Vinyl Insulated Butted Seam Flanged Block Fork

Terminal Type Fork
 Terminal Style Flanged Block
 Insulation Material Vinyl
 Barrel Style Butted
 RoHS 2011/65/EU Yes
 Agency Approval 
 Manufacturing Origin 



Product No.	UPC	Conductor Size	Stud Size	(W)	(C)	(L)	(E)	Thickness	Barrel I.D.	Max. Insul. Dia.
BS-21-6S-P	054007-28186	22 - 18 AWG	6	0.25"	0.25"	0.83"	0.70"	0.030"	0.070"	0.145"
BS-21-6-P	054007-28187	22 - 18 AWG	6	0.30"	0.25"	0.85"	0.70"	0.030"	0.070"	0.145"
BS-21-8-P	054007-28188	22 - 18 AWG	8	0.30"	0.25"	0.85"	0.70"	0.030"	0.070"	0.145"
BS-21-10-P	054007-28189	22 - 18 AWG	10	0.30"	0.25"	0.85"	0.70"	0.030"	0.070"	0.145"
BS-22-6S-P	054007-28585	16 - 14 AWG	6	0.25"	0.25"	0.84"	0.70"	0.030"	0.090"	0.170"
BS-22-6-P	054007-28586	16 - 14 AWG	6	0.30"	0.25"	0.85"	0.70"	0.030"	0.090"	0.170"
BS-22-8-P	054007-28587	16 - 14 AWG	8	0.30"	0.25"	0.85"	0.70"	0.030"	0.090"	0.170"
BS-22-10-P	054007-28588	16 - 14 AWG	10	0.30"	0.25"	0.85"	0.70"	0.030"	0.090"	0.170"
BS-23-6-P	054007-28833	12 - 10 AWG	6	0.32"	0.29"	1.03"	0.84"	0.040"	0.135"	0.250"
BS-23-8-P	054007-28834	12 - 10 AWG	8	0.32"	0.29"	1.03"	0.84"	0.040"	0.135"	0.250"
BS-23-10-P	054007-28835	12 - 10 AWG	10	0.32"	0.29"	1.03"	0.84"	0.040"	0.135"	0.250"

Nylon Insulated with Insulation Grip Flanged Block Fork

Terminal Type Fork
 Terminal Style Flanged Block
 Insulation Material Nylon with Insulation Grip
 Barrel Style Butted
 RoHS 2011/65/EU Yes
 Agency Approval 
 Manufacturing Origin 

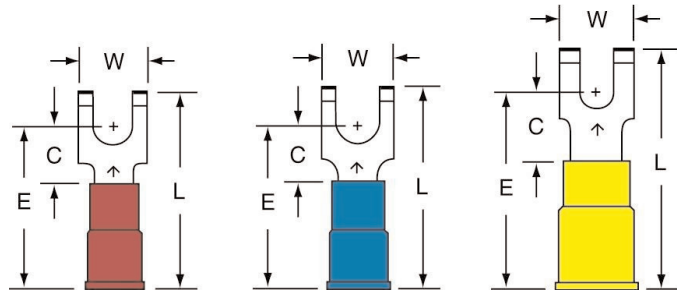

Product No.	UPC	Conductor Size	Stud Size	(W)	(C)	(L)	(E)	Thickness	Barrel I.D.	Max. Insul. Dia.
BS-21-6S-NB	054007-28182	22 - 18 AWG	6	0.25"	0.25"	0.84"	0.69"	0.030"	0.070"	0.145"
BS-21-6-NB	054007-28183	22 - 18 AWG	6	0.30"	0.25"	0.84"	0.69"	0.030"	0.070"	0.145"
BS-21-8-NB	054007-28184	22 - 18 AWG	8	0.30"	0.25"	0.84"	0.69"	0.030"	0.070"	0.145"
BS-21-10-NB	054007-28185	22 - 18 AWG	10	0.30"	0.25"	0.84"	0.69"	0.030"	0.070"	0.145"
BS-22-6S-NB	054007-28581	16 - 14 AWG	6	0.25"	0.25"	0.86"	0.71"	0.030"	0.090"	0.170"
BS-22-6-NB	054007-28582	16 - 14 AWG	6	0.30"	0.25"	0.86"	0.71"	0.030"	0.090"	0.170"

Specialty Wire Terminals, Kits and Tools



3M™ Terminals: 3M™ Flanged Block Forks

Nylon Insulated with Insulation Grip Flanged Block Fork (continued)

Product No.	UPC	Conductor Size	Stud Size	(W)	(C)	(L)	(E)	Thickness	Barrel I.D.	Max. Insul. Dia.
BS-22-8-NB	054007-28583	16 - 14 AWG	8	0.30"	0.25"	0.86"	0.71"	0.030"	0.090"	0.170"
BS-22-10-NB	054007-28584	16 - 14 AWG	10	0.30"	0.25"	0.86"	0.71"	0.030"	0.090"	0.170"
BS-23-6-NB	054007-28830	12 - 10 AWG	6	0.32"	0.29"	1.03"	0.84"	0.040"	0.135"	0.250"
BS-23-8-NB	054007-28831	12 - 10 AWG	8	0.32"	0.29"	1.03"	0.84"	0.040"	0.135"	0.250"
BS-23-10-NB	054007-28832	12 - 10 AWG	10	0.32"	0.29"	1.03"	0.84"	0.040"	0.135"	0.250"

3M™ Terminals: 3M™ Locking Forks

Non-Insulated Butted Seam Locking Fork

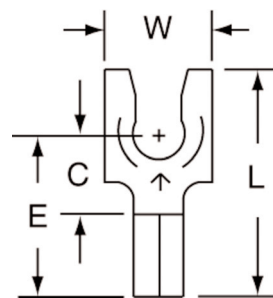

Terminal Type Fork
Terminal Style Locking
Insulation Material Non-Insulated
Barrel Style Butted
RoHS 2011/65/EU Yes
Agency Approval 
Manufacturing Origin 



Product No.	UPC	Conductor Size	Stud Size	Max. Lock Width	(W)	(C)	(L)	(E)	Thickness	Barrel I.D.
SS-31-4	054007-29966	22 - 18 AWG	4	0.27"	0.25"	0.25"	0.68"	0.50"	0.030"	0.070"
SS-31-6	054007-29967	22 - 18 AWG	6	0.27"	0.25"	0.25"	0.68"	0.50"	0.030"	0.070"
SS-31-8	054007-29968	22 - 18 AWG	8	0.34"	0.30"	0.25"	0.68"	0.50"	0.030"	0.070"
SS-31-10	054007-29969	22 - 18 AWG	10	0.35"	0.32"	0.25"	0.68"	0.50"	0.030"	0.070"
SS-32-6	054007-29971	16 - 14 AWG	6	0.27"	0.25"	0.25"	0.68"	0.50"	0.030"	0.090"
SS-32-8	054007-29972	16 - 14 AWG	8	0.34"	0.30"	0.25"	0.68"	0.50"	0.030"	0.090"
SS-32-10	054007-29973	16 - 14 AWG	10	0.35"	0.32"	0.25"	0.68"	0.50"	0.030"	0.090"
SS-32-14	054007-29974	16 - 14 AWG	1/4"	0.48"	0.43"	0.40"	0.90"	0.65"	0.030"	0.090"
SS-33-6	054007-29975	12 - 10 AWG	6	0.30"	0.28"	0.28"	0.73"	0.53"	0.040"	0.135"
SS-33-8	054007-29976	12 - 10 AWG	8	0.35"	0.32"	0.28"	0.73"	0.53"	0.040"	0.135"
SS-33-10	054007-29977	12 - 10 AWG	10	0.36"	0.32"	0.28"	0.73"	0.53"	0.040"	0.135"
SS-33-14	054007-29978	12 - 10 AWG	1/4"	0.48"	0.43"	0.44"	0.94"	0.69"	0.040"	0.135"

3M™ Terminals: 3M™ Locking Forks

Vinyl Insulated Butted Seam Locking Fork

Terminal Type Fork
 Terminal Style Locking
 Insulation Material Vinyl
 Barrel Style Butted
 RoHS 2011/65/EU Yes
 Agency Approval 
 Manufacturing Origin 

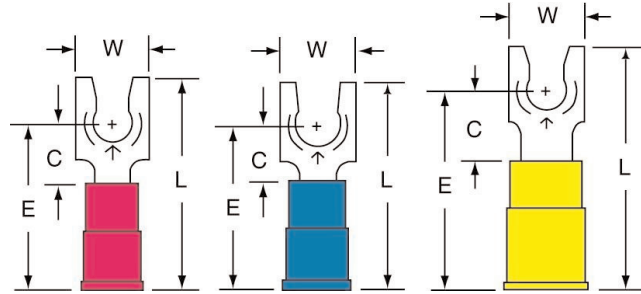



Product No.	UPC	Conductor Size	Stud Size	Max. Lock Width	(W)	(C)	(L)	(E)	Thickness	Barrel I.D.	Max. Insul. Dia.
SS-31-6-P	054007-29980	22 - 18 AWG	6	0.27"	0.25"	0.25"	0.88"	0.70"	0.030"	0.070"	0.145"
SS-31-8-P	054007-29981	22 - 18 AWG	8	0.34"	0.30"	0.25"	0.88"	0.70"	0.030"	0.070"	0.145"
SS-31-10-P	054007-29982	22 - 18 AWG	10	0.35"	0.32"	0.25"	0.88"	0.70"	0.030"	0.070"	0.145"
SS-32-4-P	054007-29983	16 - 14 AWG	4	0.27"	0.25"	0.25"	0.88"	0.70"	0.030"	0.090"	0.170"
SS-32-6-P	054007-29984	16 - 14 AWG	6	0.27"	0.25"	0.25"	0.88"	0.70"	0.030"	0.090"	0.170"
SS-32-8-P	054007-29985	16 - 14 AWG	8	0.34"	0.30"	0.25"	0.88"	0.70"	0.030"	0.090"	0.170"
SS-32-10-P	054007-29986	16 - 14 AWG	10	0.35"	0.25"	0.25"	0.88"	0.70"	0.030"	0.090"	0.170"
SS-32-14-P	054007-29987	16 - 14 AWG	1/4"	0.48"	0.43"	0.40"	1.10"	0.85"	0.030"	0.090"	0.170"
SS-33-6-P	054007-29988	12 - 10 AWG	6	0.30"	0.28"	0.28"	1.03"	0.83"	0.040"	0.135"	0.250"
SS-33-8-P	054007-29989	12 - 10 AWG	8	0.35"	0.32"	0.28"	1.03"	0.83"	0.040"	0.135"	0.250"
SS-33-10-P	054007-29990	12 - 10 AWG	10	0.36"	0.32"	0.28"	1.03"	0.83"	0.040"	0.135"	0.250"
SS-33-14-P	054007-29991	12 - 10 AWG	1/4"	0.48"	0.43"	0.44"	1.24"	0.99"	0.040"	0.135"	0.250"

Specialty Wire Terminals, Kits and Tools

3M™ Terminals: 3M™ Locking Forks

Nylon Insulated with Insulation Grip Locking Fork

Terminal Type Fork
Terminal Style Locking
Insulation Material Nylon with Insulation Grip
Barrel Style Butted
RoHS 2011/65/EU Yes
Agency Approval 
Manufacturing Origin 

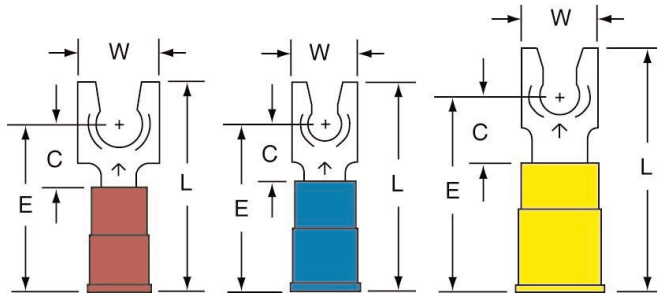

Product No.	UPC	Conductor Size	Stud Size	Max. Lock Width	(W)	(C)	(L)	(E)	Thickness	Barrel I.D.	Max. Insul. Dia.
SS-31-4-NB	054007-29992	22 - 18 AWG	4	0.27"	0.25"	0.25"	0.87"	0.69"	0.030"	0.070"	0.145"
SS-31-6-NB	054007-29993	22 - 18 AWG	6	0.27"	0.25"	0.25"	0.87"	0.69"	0.030"	0.070"	0.145"
SS-31-8-NB	054007-29994	22 - 18 AWG	8	0.34"	0.30"	0.25"	0.87"	0.69"	0.030"	0.070"	0.145"
SS-31-10-NB	054007-29995	22 - 18 AWG	10	0.35"	0.32"	0.25"	0.87"	0.69"	0.030"	0.070"	0.145"
SS-32-4-NB	054007-29996	16 - 14 AWG	4	0.27"	0.25"	0.25"	0.89"	0.71"	0.030"	0.090"	0.170"
SS-32-6-NB	054007-29997	16 - 14 AWG	6	0.27"	0.24"	0.25"	0.89"	0.71"	0.030"	0.090"	0.170"
SS-32-8-NB	054007-29998	16 - 14 AWG	8	0.34"	0.30"	0.25"	0.89"	0.71"	0.030"	0.090"	0.170"
SS-32-10-NB	054007-29999	16 - 14 AWG	10	0.35"	0.32"	0.25"	0.89"	0.71"	0.030"	0.090"	0.170"
SS-32-14-NB	054007-30000	16 - 14 AWG	1/4"	0.48"	0.43"	0.40"	1.11"	0.86"	0.030"	0.090"	0.170"
SS-33-6-NB	054007-30001	12 - 10 AWG	6	0.30"	0.28"	0.28"	1.03"	0.83"	0.040"	0.135"	0.250"
SS-33-8-NB	054007-30002	12 - 10 AWG	8	0.35"	0.32"	0.28"	1.03"	0.83"	0.040"	0.135"	0.250"
SS-33-10-NB	054007-30003	12 - 10 AWG	10	0.36"	0.32"	0.28"	1.03"	0.83"	0.040"	0.135"	0.250"
SS-33-14-NB	054007-30004	12 - 10 AWG	1/4"	0.48"	0.43"	0.44"	1.24"	0.99"	0.040"	0.135"	0.250"

Specialty Wire Terminals, Kits and Tools

3M™ Terminals: 3M™ Locking Forks

Heat Shrink Brazed Seam Locking Fork

Terminal Type	Fork
Terminal Style	Locking
Insulation Material	Heat Shrink
Barrel Style	Brazed
RoHS 2011/65/EU	Yes
Manufacturing Origin	

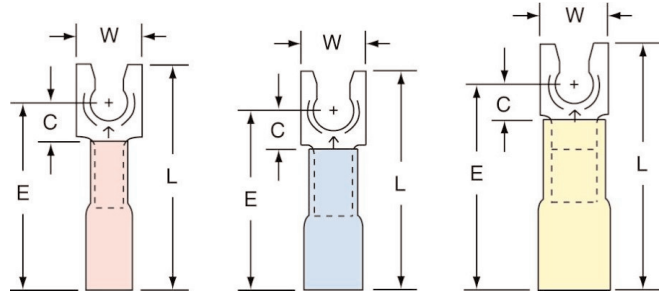



Product No.	UPC	Conductor Size	Stud Size	(W)	(C)	(L)	(E)	Thickness	Barrel I.D.
MH18-6FLK	054007-06347	22 - 18 AWG	6	0.25"	0.15"	1.00"	0.76"	0.030"	0.070"
MH18-6FLX	051128-58911	22 - 18 AWG	6	0.25"	0.15"	1.00"	0.76"	0.030"	0.070"
MH18-8FLK	054007-06362	22 - 18 AWG	8	0.30"	0.15"	1.00"	0.70"	0.030"	0.070"
MH18-8FLX	051128-59096	22 - 18 AWG	8	0.30"	0.15"	1.00"	0.70"	0.030"	0.070"
MH18-10FLK	054007-06353	22 - 18 AWG	10	0.32"	0.15"	1.00"	0.76"	0.030"	0.070"
MH18-10FLX	051128-58915	22 - 18 AWG	10	0.32"	0.15"	1.00"	0.76"	0.030"	0.070"
MH14-6FLX	051128-58899	16 - 14 AWG	6	0.25"	0.12"	1.00"	0.76"	0.030"	0.090"
MH14-6FLK	054007-06323	16 - 14 AWG	6	0.25"	0.12"	1.00"	0.76"	0.030"	0.090"
MH14-8FLX	051128-59094	16 - 14 AWG	8	0.30"	0.12"	1.00"	0.70"	0.030"	0.090"
MH14-8FLK	054007-06360	16 - 14 AWG	8	0.30"	0.12"	1.00"	0.70"	0.030"	0.090"
MH14-10FLX	051128-58902	16 - 14 AWG	10	0.32"	0.12"	1.00"	0.76"	0.030"	0.090"
MH14-10FLK	054007-06329	16 - 14 AWG	10	0.32"	0.12"	1.00"	0.76"	0.030"	0.090"
MH14-14FLX	051128-58904	16 - 14 AWG	1/4"	0.43"	0.27"	1.10"	0.85"	0.030"	0.090"
MH14-14FLK	054007-06333	16 - 14 AWG	1/4"	0.43"	0.27"	1.10"	0.85"	0.030"	0.090"
MH10-8FLX	051128-58889	12 - 10 AWG	8	0.32"	0.16"	1.00"	0.80"	0.040"	0.135"
MH10-8FLK	054007-06358	12 - 10 AWG	8	0.32"	0.16"	1.00"	0.80"	0.040"	0.135"
MH10-10FLX	051128-58891	12 - 10 AWG	10	0.32"	0.16"	1.00"	0.80"	0.040"	0.135"
MH10-10FLK	054007-06308	12 - 10 AWG	10	0.32"	0.16"	1.00"	0.80"	0.040"	0.135"
MH10-14FLX	051128-58893	12 - 10 AWG	1/4"	0.43"	0.30"	1.20"	0.95"	0.040"	0.135"
MH10-14FLK	054007-06311	12 - 10 AWG	1/4"	0.43"	0.30"	1.20"	0.95"	0.040"	0.135"

Specialty Wire Terminals, Kits and Tools

3M™ Terminals: 3M™ Butt Connectors

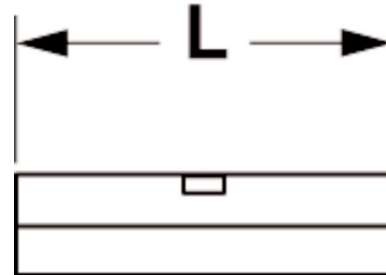

Non-Insulated Butted Seam Butt Connector

Terminal Type: Butt
 Terminal Style: Standard
 Insulation Material: Non-Insulated
 Barrel Style: Butted
 RoHS 2011/65/EU: Yes
 Agency Approval: 
 Manufacturing Origin: 



Product No.	UPC	Conductor Size	(L)	Thickness	Barrel Length	Barrel I.D.
61	054007-28261	22 - 18 AWG	0.56"	0.030"	0.25"	0.070"
62	054007-28659	16 - 14 AWG	0.56"	0.030"	0.25"	0.090"
63	054007-28868	12 - 10 AWG	0.56"	0.040"	0.25"	0.135"

Non-Insulated Seamless Butt Connector

Terminal Type: Butt
 Terminal Style: Standard
 Insulation Material: Non-Insulated
 Barrel Style: Seamless
 RoHS 2011/65/EU: Yes
 Agency Approval: 
 Manufacturing Origin: 

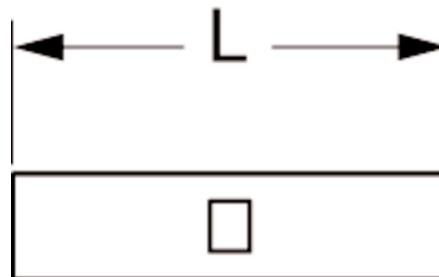

Product No.	UPC	Conductor Size	(L)	Thickness	Barrel Length	Barrel I.D.
61-S	054007-28262	22 - 18 AWG	0.63"	0.031"	0.28"	0.062"
62-S	054007-28660	16 - 14 AWG	0.66"	0.031"	0.30"	0.095"
63-S	054007-28869	12 - 10 AWG	0.81"	0.038"	0.38"	0.142"

Specialty Wire Terminals, Kits and Tools

3M™ Terminals: 3M™ Butt Connectors

Nylon Insulated Seamless Butt Connector

Terminal Type Butt
 Terminal Style Standard
 Insulation Material Nylon
 Barrel Style Seamless
 RoHS 2011/65/EU Yes

Agency Approval  Except for 26-24 AWG Butt Connectors

Manufacturing Origin  Product numbers ending with "-A" are made in Taiwan

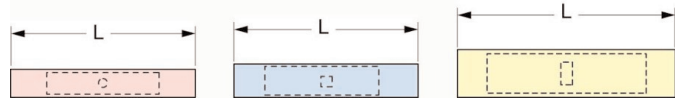

Product No.	UPC	Conductor Size	(L)	Thickness	Barrel Length	Barrel I.D.	Max. Insul. Dia.
61-SN	051128-56170	22 - 18 AWG	1.02"	0.031"	0.28"	0.062"	0.125"
62-SN	051128-56171	16 - 14 AWG	1.02"	0.031"	0.30"	0.095"	0.155"
63-SN	051128-56172	12 - 10 AWG	1.20"	0.038"	0.38"	0.142"	0.218"
61-SN-A	054007-28260	22 - 18 AWG	1.02"	0.031"	0.28"	0.062"	0.125"
62-SN-A	054007-28658	16 - 14 AWG	1.02"	0.031"	0.30"	0.095"	0.155"
63-SN-A	054007-28867	12 - 10 AWG	1.20"	0.038"	0.38"	0.142"	0.218"

Non-Insulated Brazed Seam Butt Connector

Terminal Type Butt
 Terminal Style Standard
 Insulation Material Non-Insulated
 Barrel Style Brazed
 RoHS 2011/65/EU Yes

Agency Approval 

Manufacturing Origin 

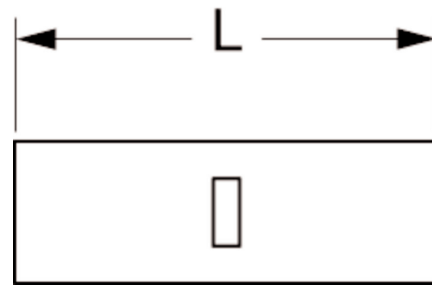



Product No.	UPC	Conductor Size	(L)	Thickness	Barrel Length	Barrel I.D.
64-W	054007-29099	8 AWG	0.81"	0.050"	0.38"	0.175"
65-W	054007-29127	6 AWG	1.02"	0.050"	0.47"	0.250"
66-W	054007-29151	4 AWG	1.13"	0.075"	0.53"	0.280"

Specialty Wire Terminals, Kits and Tools

3M™ Terminals: 3M™ Butt Connectors

Non-Insulated Seamless Compression Butt Connector

Terminal Type Butt
 Terminal Style Compression Connector
 Insulation Material Non-Insulated
 Barrel Style Seamless
 RoHS 2011/65/EU Yes

Agency Approval  

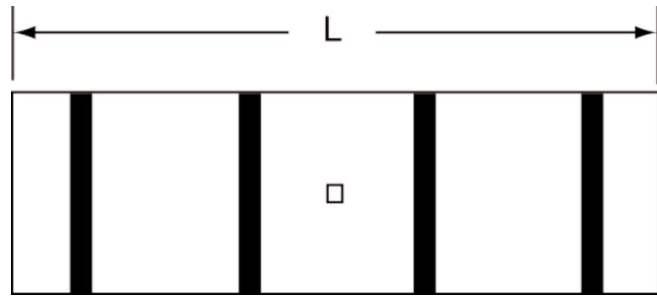

Manufacturing Origin 



Product No.	UPC	Conductor Size	(L)	Barrel I.D.
MC2BC	054007-09205	2 AWG	1.35"	0.341"
MC1BC	054007-09206	1 AWG	1.35"	0.365"
MC1/OBC	054007-09207	1/0 AWG	1.55"	0.412"
MC2/OBC	054007-09208	2/0 AWG	1.80"	0.466"
MC3/OBC	054007-09209	3/0 AWG	1.90"	0.516"
MC4/OBC	054007-09210	4/0 AWG	2.00"	0.564"
MC250BC	054007-09211	250 kcmil	2.00"	0.595"

Vinyl Insulated Seamless Butt Connector

Terminal Type Butt
 Terminal Style Standard
 Insulation Material Vinyl
 Barrel Style Seamless
 RoHS 2011/65/EU Yes

Agency Approval  

Manufacturing Origin 

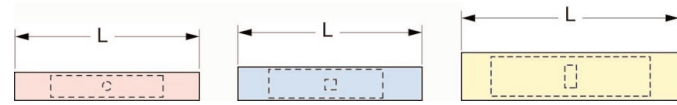



Product No.	UPC	Conductor Size	(L)	Thickness	Barrel Length	Barrel I.D.	Max. Insul. Dia.
61-SP	054007-29686	22 - 18 AWG	1.02"	0.031"	0.28"	0.062"	0.125"
62-SP	054007-29452	16 - 14 AWG	1.02"	0.031"	0.30"	0.095"	0.155"
63-SP	054007-29453	12 - 10 AWG	1.20"	0.038"	0.38"	0.142"	0.218"

Specialty Wire Terminals, Kits and Tools

3M™ Terminals: 3M™ Butt Connectors

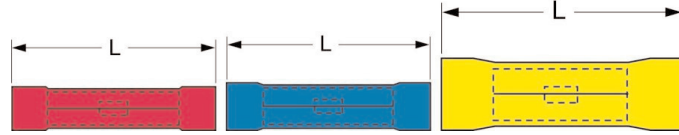

Vinyl Insulated Butted Seam Butt Connector

Terminal Type Butt
 Terminal Style Standard
 Insulation Material Vinyl
 Barrel Style Butted
 RoHS 2011/65/EU Yes
 Agency Approval 
 Manufacturing Origin 



Product No.	UPC	Conductor Size	(L)	Thickness	Barrel Length	Barrel I.D.	Max. Insul. Dia.
61-P	054007-28259	22 - 18 AWG	1.00"	0.030"	0.25"	0.070"	0.145"
62-P	054007-28657	16 - 14 AWG	1.00"	0.030"	0.25"	0.090"	0.170"
63-P	054007-28866	12 - 10 AWG	1.02"	0.040"	0.25"	0.135"	0.250"

Vinyl Insulated Brazed Seam Butt Connector

Terminal Type Butt
 Terminal Style Standard
 Insulation Material Vinyl
 Barrel Style Brazed
 RoHS 2011/65/EU Yes
 Agency Approval 
 Manufacturing Origin 

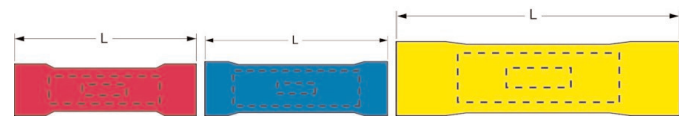



Product No.	UPC	Conductor Size	(L)	Thickness	Barrel Length	Barrel I.D.	Max. Insul. Dia.
64-WP	054007-29849	8 AWG	1.50"	0.050"	0.38"	0.175"	0.300"
65-WP	054007-29850	6 AWG	1.71"	0.050"	0.47"	0.250"	0.400"
66-WP	054007-29851	4 AWG	2.17"	0.075"	0.53"	0.280"	0.480"

Specialty Wire Terminals, Kits and Tools

3M™ Terminals: 3M™ Butt Connectors

Nylon Insulated with Insulation Grip Butt Connector

Terminal Type: Butt
 Terminal Style: Standard
 Insulation Material: Nylon with Insulation Grip
 Barrel Style: Butted
 RoHS 2011/65/EU: Yes

Agency Approval:  

Manufacturing Origin:  With U.S. and Global Content

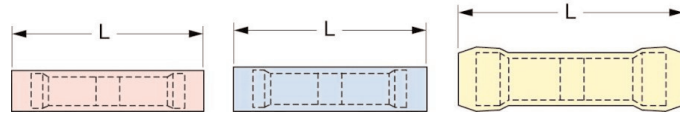

Product No.	UPC	Conductor Size	(L)	Thickness	Barrel Length	Barrel I.D.	Max. Insul. Dia.
61-NB	054007-28258	22 - 18 AWG	1.00"	0.030"	0.25"	0.070"	0.145"
62-NB	054007-28656	16 - 14 AWG	1.00"	0.030"	0.25"	0.090"	0.170"
63-NB	054007-28865	12 - 10 AWG	1.15"	0.040"	0.25"	0.135"	0.250"

Nylon Insulated with Insulation Grip Grease Filled Butt Connector

Terminal Type: Butt
 Terminal Style: Moisture Resistant
 Insulation Material: Nylon with Insulation Grip
 Barrel Style: Butted
 RoHS 2011/65/EU: Yes
 Manufacturing Origin: Taiwan

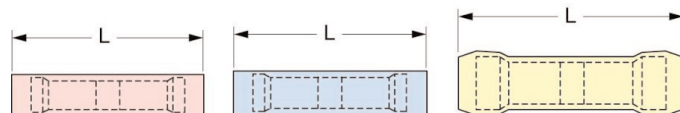



Product No.	UPC	Conductor Size	(L)	Thickness	Barrel Length	Barrel I.D.	Max. Insul. Dia.
61-NBM-A	051138-98028	22 - 18 AWG	1.02"	0.030"	0.25"	0.070"	0.145"
62-NBM-A	051138-98033	16 - 14 AWG	1.06"	0.030"	0.25"	0.090"	0.170"
63-NBM-A	051138-98038	12 - 10 AWG	1.23"	0.040"	0.25"	0.135"	0.250"

Specialty Wire Terminals, Kits and Tools

3M™ Terminals: 3M™ Female Disconnects

Non-Insulated Butted Seam Female Disconnect

Terminal Type	Disconnect
Terminal Style	Standard
Fastener Orientation	Female
Insulation Material	Non-Insulated
Barrel Style	Butted
RoHS 2011/65/EU	Yes
Agency Approval	 Except for 110 & 110/32 Female Disconnects
Manufacturing Origin	 Product numbers ending with "-A" are made in Taiwan

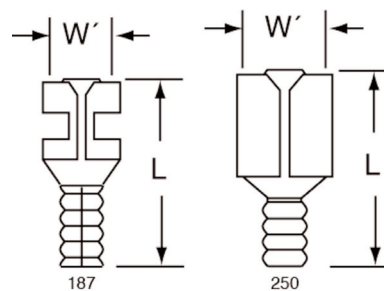

Product No.	UPC	Conductor Size	Mates with Male Tab Width (W')	(L)	Thickness	Barrel I.D.
71F-187-20	054007-30129	22 - 18 AWG	0.187"	0.58"	0.020"	0.085"
71F-250-32	054007-29174	22 - 18 AWG	0.250"	0.66"	0.032"	0.080"
72F-110-20-A	051128-57420	16 - 14 AWG	0.110"	0.54"	0.020"	0.115"
72F-187-20	054007-29177	16 - 14 AWG	0.187"	0.58"	0.020"	0.085"
72F-250-32	054007-29178	16 - 14 AWG	0.250"	0.66"	0.032"	0.080"
73F-250-32	054007-29179	12 - 10 AWG	0.250"	0.66"	0.032"	0.165"
73F-375-50	054007-29180	12 - 10 AWG	0.375"	0.93"	0.050"	0.250"

Specialty Wire Terminals, Kits and Tools

3M™ Terminals: 3M™ Female Disconnects

Non-Insulated Butted Seam Flag Female Disconnect

Terminal Type Disconnect
 Terminal Style Flag
 Fastener Orientation Female
 Insulation Material Non-Insulated
 Barrel Style Butted
 RoHS 2011/65/EU Yes

Agency Approval  Except for 187 Flag Female Disconnects

Manufacturing Origin 

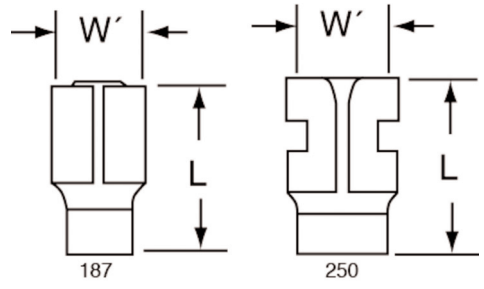

Product No.	UPC	Conductor Size	Mates with Male Tab Width (W')	(L)	Thickness	Barrel I.D.
751-187	054007-29484	22 - 18 AWG	0.187"	0.46"	0.020"	0.075"
751-250	054007-29412	22 - 18 AWG	0.250"	0.50"	0.032"	0.075"
752-187	054007-29486	16 - 14 AWG	0.187"	0.47"	0.020"	0.095"
752-250	054007-29413	16 - 14 AWG	0.250"	0.51"	0.032"	0.095"

Vinyl Insulated with Insulation Grip Female Disconnect

Terminal Type Disconnect
 Terminal Style Standard
 Fastener Orientation Female
 Insulation Material Vinyl with Insulation Grip
 Barrel Style Butted
 RoHS 2011/65/EU Yes

Manufacturing Origin 

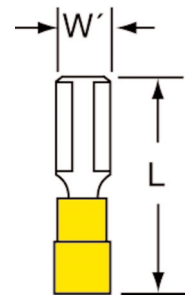



Product No.	UPC	Conductor Size	Mates with Male Tab Width (W')	Thickness	(L)	Barrel I.D.	Max. Insul. Dia.
70F-110-20-PB	054007-95149	26 - 24 AWG	0.110"	0.020"	0.63"	0.055"	0.093"
70F-110-32-PB	054007-95174	26 - 24 AWG	0.110"	0.032"	0.63"	0.055"	0.093"

Specialty Wire Terminals, Kits and Tools

3M™ Terminals: 3M™ Female Disconnects

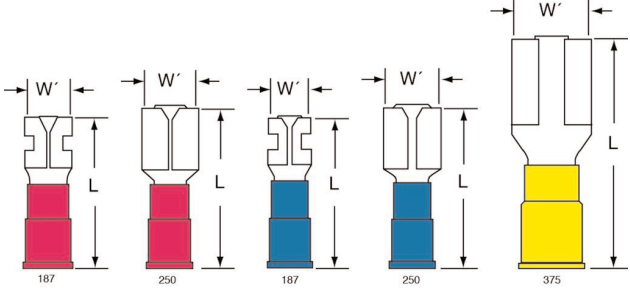

Vinyl Insulated Butted Seam Female Disconnect

Terminal Type	Disconnect
Terminal Style	Standard
Fastener Orientation	Female
Insulation Material	Vinyl
Barrel Style	Butted
RoHS 2011/65/EU	Yes
Agency Approval	 Except for 110DF Female Disconnects
Manufacturing Origin	 Product numbers ending with "-A" are made in Taiwan



Product No.	UPC	Conductor Size	Mates with Male Tab Width (W')	Thickness	(L)	Barrel I.D.	Max. Insul. Dia.
71F-187-20-P	054007-30132	22 - 18 AWG	0.187"	0.020"	0.78"	0.085"	0.145"
71F-250-32-P	054007-29618	22 - 18 AWG	0.250"	0.032"	0.87"	0.080"	0.145"
72F-110-20-P-A	051128-57429	16 - 14 AWG	0.110"	0.020"	0.81"	0.115"	0.145"
72F-187-20-P	054007-29168	16 - 14 AWG	0.187"	0.020"	0.78"	0.085"	0.145"
72F-250-32-P	054007-29169	16 - 14 AWG	0.250"	0.032"	0.87"	0.080"	0.145"
73F-250-32-P	054007-29170	12 - 10 AWG	0.250"	0.032"	0.95"	0.165"	0.250"
73F-375-50-P	054007-29171	12 - 10 AWG	0.375"	0.050"	1.23"	0.175"	0.250"

Nylon Fully Insulated Butted Seam Female Disconnect

Terminal Type	Disconnect
Terminal Style	Fully Insulated
Fastener Orientation	Female
Insulation Material	Nylon
Barrel Style	Butted
RoHS 2011/65/EU	Yes
Agency Approval	
Manufacturing Origin	

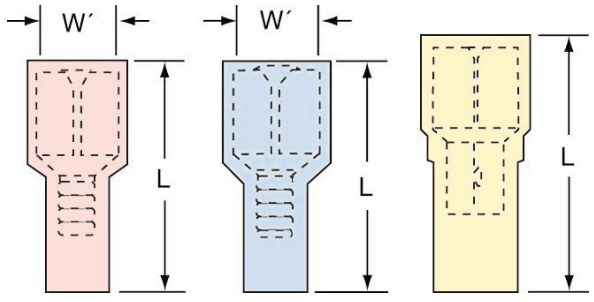

Product No.	UPC	Conductor Size	Mates with Male Tab Width (W')	(W)	(L)	Diameter (D)	Thickness	Barrel I.D.	Max. Insul. Dia.
71F-187-20-NL	054007-30125	22 - 18 AWG	0.187"	0.30"	0.81"	0.23"	0.020"	0.085"	0.145"
71F-250-32-NL	054007-30108	22 - 18 AWG	0.250"	0.37"	0.87"	0.23"	0.032"	0.080"	0.145"
72F-187-20-NL	054007-30134	16 - 14 AWG	0.187"	0.30"	0.81"	0.23"	0.020"	0.085"	0.145"
72F-250-32-NL	054007-30091	16 - 14 AWG	0.250"	0.37"	0.87"	0.23"	0.032"	0.080"	0.145"
73F-250-32-NL	054007-30104	12 - 10 AWG	0.250"	0.39"	0.99"	0.32"	0.032"	0.148"	0.250"

Specialty Wire Terminals, Kits and Tools

3M™ Terminals: 3M™ Female Disconnects

Nylon Fully Insulated with Insulation Grip Female Disconnect

Terminal Type Disconnect
 Terminal Style Fully Insulated
 Fastener Orientation Female
 Insulation Material Nylon with Insulation Grip
 Barrel Style Butted
 RoHS 2011/65/EU Yes
 Agency Approval 
 Manufacturing Origin 

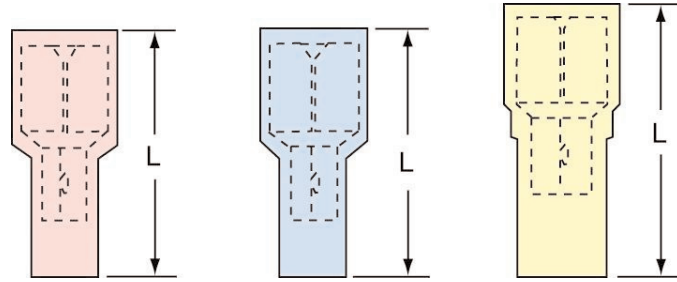

Product No.	UPC	Conductor Size	Mates with Male Tab Width (W')	(L)	(W)	Diameter (D)	Thickness	Barrel I.D.	Max. Insul. Dia.
71F-187-20-NBL	054007-30126	22 - 18 AWG	0.187"	0.81"	0.30"	0.23"	0.020"	0.085"	0.145"
71F-250-32-NBL	054007-30110	22 - 18 AWG	0.250"	0.87"	0.37"	0.23"	0.032"	0.080"	0.145"
72F-187-20-NBL	054007-29446	16 - 14 AWG	0.187"	0.81"	0.30"	0.23"	0.020"	0.085"	0.145"
72F-250-32-NBL	054007-29447	16 - 14 AWG	0.250"	0.87"	0.37"	0.23"	0.032"	0.080"	0.145"
73F-250-32-NBL	054007-30106	12 - 10 AWG	0.250"	0.99"	0.39"	0.32"	0.032"	0.165"	0.250"

Specialty Wire Terminals, Kits and Tools

3M™ Terminals: 3M™ Female Disconnects

Nylon Insulated with Insulation Grip Female Disconnect

Terminal Type Disconnect
 Terminal Style Standard
 Fastener Orientation Female
 Insulation Material Nylon with Insulation Grip
 Barrel Style Butted
 RoHS 2011/65/EU Yes

Agency Approval  Except for 110 & 375 Female Disconnects

Manufacturing Origin

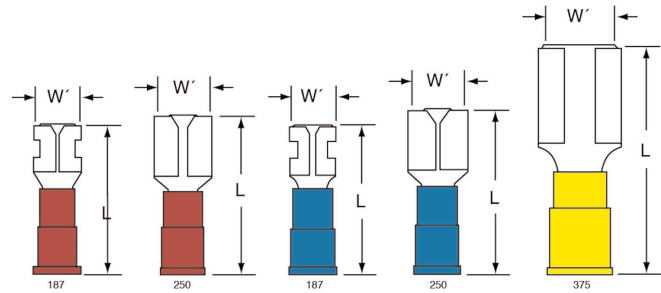

Product No.	UPC	Conductor Size	Mates with Male Tab Width (W')	Thickness	(L)	Barrel I.D.	Max. Insul. Dia.
71F-110-20-NB-A	051128-57472	22 - 18 AWG	0.110"	0.020"	0.77"	0.115"	0.160"
71F-187-20-NB	054007-30131	22 - 18 AWG	0.187"	0.020"	0.77"	0.085"	0.145"
71F-250-32-NB	054007-30116	22 - 18 AWG	0.250"	0.032"	0.86"	0.080"	0.145"
72F-110-20-NB-A	051128-57427	16 - 14 AWG	0.110"	0.020"	0.77"	0.115"	0.200"
72F-187-20-NB	054007-29162	16 - 14 AWG	0.187"	0.020"	0.77"	0.085"	0.145"
72F-250-32-NB	054007-29163	16 - 14 AWG	0.250"	0.032"	0.86"	0.080"	0.145"
73F-250-32-NB	054007-29164	12 - 10 AWG	0.250"	0.032"	0.96"	0.165"	0.250"
73F-375-50-NB	054007-29165	12 - 10 AWG	0.375"	0.050"	1.23"	0.175"	0.250"

Nylon Insulated with Insulation Grip Bullet Style Female Disconnect

Terminal Type Disconnect
 Terminal Style Bullet Snap Plug
 Fastener Orientation Female
 Insulation Material Nylon with Insulation Grip
 Barrel Style Butted
 RoHS 2011/65/EU Yes

Manufacturing Origin Taiwan

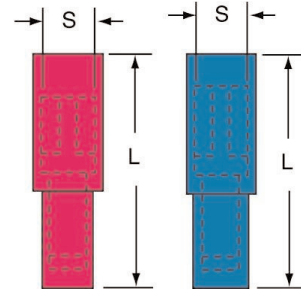

Product No.	UPC	Conductor Size	Mating Snap Diameter (S)	(L)	Barrel I.D.	Max. Insul. Dia.
81F-156-NBL-A	051138-98077	22 - 18 AWG	0.156"	0.99"	0.145"	0.150"
81F-180-NBL-A	051138-98083	22 - 18 AWG	0.180"	1.00"	0.095"	0.150"
82F-156-NBL-A	051138-98116	16 - 14 AWG	0.156"	0.99"	0.115"	0.190"
82F-180-NBL-A	051138-98126	16 - 14 AWG	0.180"	1.00"	0.115"	0.190"

3M™ Terminals: 3M™ Female Disconnects

Heat Shrink Nylon Fully Insulated Female Disconnect

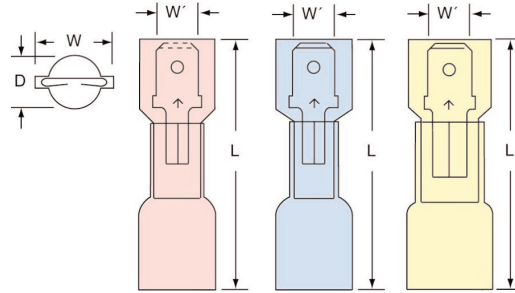

Terminal Type	Disconnect
Terminal Style	Fully Insulated
Fastener Orientation	Female
Insulation Material	Heat Shrink
Barrel Style	Butted
RoHS 2011/65/EU	Yes
Manufacturing Origin	



Product No.	UPC	Conductor Size	Male Tab Width (W')	(W)	(L)	Diameter (D)	Thickness	Barrel I.D.
MNHU18-250DFI	051128-58916	22 - 18 AWG	0.250"	0.37"	1.20"	0.23"	0.032"	0.080"
MNHU14-250DFI	051128-58907	16 - 14 AWG	0.250"	0.37"	1.20"	0.23"	0.032"	0.080"
MNHU10-250DFI	051128-58895	12 - 10 AWG	0.250"	0.39"	1.20"	0.32"	0.032"	0.165"

3M™ Terminals: 3M™ Male Disconnects

Non-Insulated Butted Seam Male Disconnect

Terminal Type	Disconnect
Terminal Style	Standard
Fastener Orientation	Male
Insulation Material	Non-Insulated
Barrel Style	Butted
RoHS 2011/65/EU	Yes
Agency Approval	 
Manufacturing Origin	

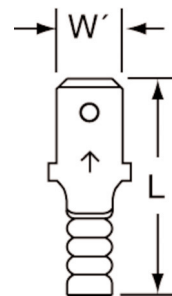

Product No.	UPC	Conductor Size	Male Tab Width (W')	(L)	Thickness	Barrel I.D.
71M-187-20	054007-30127	22 - 18 AWG	0.187"	0.64"	0.020"	0.080"
71M-250-32	054007-30112	22 - 18 AWG	0.250"	0.73"	0.032"	0.065"
72M-187-20	054007-29236	16 - 14 AWG	0.187"	0.64"	0.020"	0.080"
72M-250-32	054007-29237	16 - 14 AWG	0.250"	0.73"	0.032"	0.085"
73M-250-32	054007-29238	12 - 10 AWG	0.250"	0.75"	0.032"	0.150"

Specialty Wire Terminals, Kits and Tools

3M™ Terminals: 3M™ Male Disconnects

Non-Insulated Butted Seam Bullet Style Male Disconnect

Terminal Type	Disconnect
Terminal Style	Bullet Snap Plug
Fastener Orientation	Male
Insulation Material	Non-Insulated
Barrel Style	Butted
RoHS 2011/65/EU	Yes
Manufacturing Origin	Taiwan

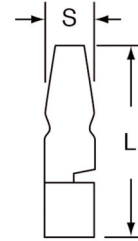

Product No.	UPC	Conductor Size	Mating Snap Diameter (S)	(L)	Max. Insul. Dia.
82M-156-A	051128-57435	16 - 14 AWG	0.156"	0.83"	0.170"
82M-180-A	051128-57412	16 - 14 AWG	0.180"	0.83"	0.170"

Non-Insulated Rectangular Tongue Male Adapter Disconnect

Terminal Type	Disconnect
Terminal Style	Standard
Fastener Orientation	Male
Insulation Material	Non-Insulated
Barrel Style	NA
RoHS 2011/65/EU	Yes
Manufacturing Origin	

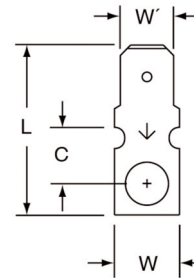

Product No.	UPC	Stud Size	Male Tab Width (W')	Thickness	(W)	(C)	(L)
07-6-250	054007-29418	6	0.250"	0.030"	0.30"	0.26"	0.80"
07-8-250	054007-29419	8	0.250"	0.030"	0.30"	0.26"	0.80"
07-10-250	054007-29420	10	0.250"	0.030"	0.30"	0.26"	0.80"

Specialty Wire Terminals, Kits and Tools

3M™ Terminals: 3M™ Male Disconnects

Non-Insulated Ring Tongue Male Adapter Disconnect

Terminal Type	Disconnect
Terminal Style	Standard
Fastener Orientation	Male
Insulation Material	Non-Insulated
Barrel Style	NA
RoHS 2011/65/EU	Yes
Manufacturing Origin	

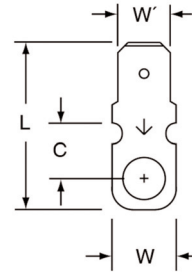

Product No.	UPC	Stud Size	Male Tab Width (W')	Thickness (W)	(C)	(L)
17-6-250	054007-29415	6	0.250"	0.030"	0.34"	0.83"
17-8-250	054007-29416	8	0.250"	0.030"	0.34"	0.83"
17-10-250	054007-29417	10	0.250"	0.030"	0.34"	0.83"

Vinyl Insulated Butted Seam Male Disconnect

Terminal Type	Disconnect
Terminal Style	Standard
Fastener Orientation	Male
Insulation Material	Vinyl
Barrel Style	Butted
RoHS 2011/65/EU	Yes
Agency Approval	
Manufacturing Origin	

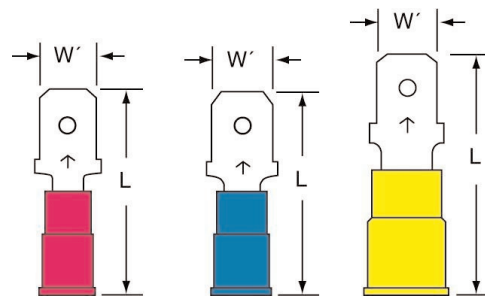

Product No.	UPC	Conductor Size	Male Tab Width (W')	(L)	Thickness	Barrel I.D.	Max. Insul. Dia.
71M-187-20-P	054007-30122	22 - 18 AWG	0.187"	0.85"	0.020"	0.080"	0.145"
71M-250-32-P	054007-30115	22 - 18 AWG	0.250"	0.93"	0.032"	0.065"	0.145"
72M-187-20-P	054007-29233	16 - 14 AWG	0.187"	0.85"	0.020"	0.080"	0.145"
72M-250-32-P	054007-29234	16 - 14 AWG	0.250"	0.93"	0.032"	0.085"	0.170"
73M-250-32-P	054007-29235	12 - 10 AWG	0.250"	1.05"	0.032"	0.150"	0.250"

Specialty Wire Terminals, Kits and Tools

3M™ Terminals: 3M™ Male Disconnects

Vinyl Insulated Butted Seam Bullet Style Male Disconnect

Terminal Type	Disconnect
Terminal Style	Bullet Snap Plug
Fastener Orientation	Male
Insulation Material	Vinyl
Barrel Style	Butted
RoHS 2011/65/EU	Yes
Manufacturing Origin	Taiwan

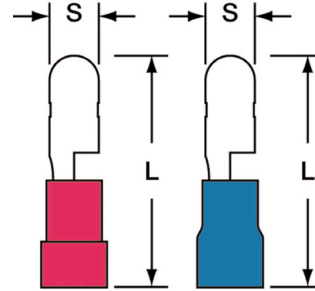

Product No.	UPC	Conductor Size	Mating Snap Diameter (S)	(L)	Max. Insul. Dia.
81M-156-P-A	051138-98093	22 - 18 AWG	0.156"	0.83"	0.150"
81M-180-P-A	051138-98103	22 - 18 AWG	0.180"	0.83"	0.150"
82M-156-P-A	054007-29248	16 - 14 AWG	0.156"	0.83"	0.170"
82M-180-P-A	051138-98161	16 - 14 AWG	0.180"	0.83"	0.170"

Nylon Fully Insulated Butted Seam Male Disconnect

Terminal Type	Disconnect
Terminal Style	Fully Insulated
Fastener Orientation	Male
Insulation Material	Nylon
Barrel Style	Butted
RoHS 2011/65/EU	Yes
Agency Approval	
Manufacturing Origin	

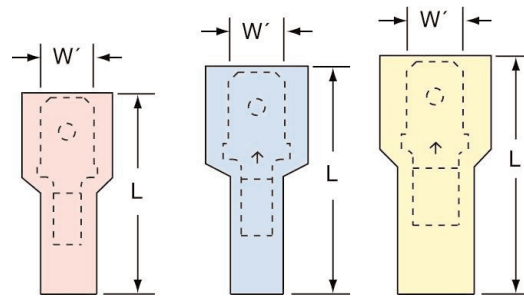

Product No.	UPC	Conductor Size	Male Tab Width (W')	(L)	(W)	Diameter (D)	Thickness	Barrel I.D.	Max. Insul. Dia.
71M-187-20-NL	054007-30123	22 - 18 AWG	0.187"	0.87"	0.37"	0.30"	0.020"	0.080"	0.145"
71M-250-32-NL	054007-30109	22 - 18 AWG	0.250"	0.95"	0.44"	0.30"	0.032"	0.065"	0.170"
72M-187-20-NL	054007-30139	16 - 14 AWG	0.187"	0.87"	0.37"	0.30"	0.020"	0.080"	0.145"
72M-250-32-NL	054007-30092	16 - 14 AWG	0.250"	0.95"	0.44"	0.30"	0.032"	0.085"	0.170"
73M-250-32-NL	054007-30105	12 - 10 AWG	0.250"	1.05"	0.47"	0.39"	0.032"	0.150"	0.250"

Specialty Wire Terminals, Kits and Tools

3M™ Terminals: 3M™ Male Disconnects

Nylon Fully Insulated with Insulation Grip Male Disconnect

Terminal Type Disconnect
 Terminal Style Fully Insulated
 Fastener Orientation Male
 Insulation Material Nylon with Insulation Grip
 Barrel Style Butted
 RoHS 2011/65/EU Yes
 Agency Approval 
 Manufacturing Origin  With U.S. and Global Content

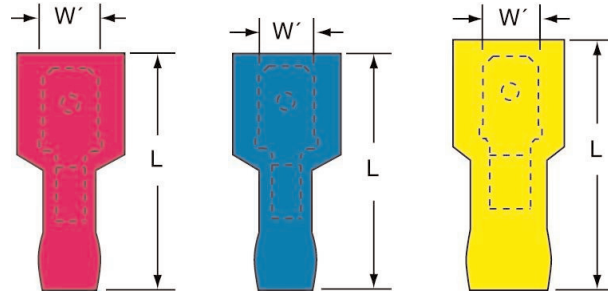

Product No.	UPC	Conductor Size	Male Tab Width (W')	(L)	(W)	Diameter (D)	Thickness	Barrel I.D.
71M-187-20-NBL	054007-30124	22 - 18 AWG	0.187"	0.87"	0.37"	0.30"	0.020"	0.145"
71M-250-32-NBL	054007-30111	22 - 18 AWG	0.250"	0.95"	0.44"	0.30"	0.032"	0.145"
72M-187-20-NBL	054007-30140	16 - 14 AWG	0.187"	0.87"	0.37"	0.30"	0.020"	0.145"
72M-250-32-NBL	054007-30093	16 - 14 AWG	0.250"	0.95"	0.44"	0.30"	0.032"	0.170"
73M-250-32-NBL	054007-30107	12 - 10 AWG	0.250"	1.05"	0.47"	0.39"	0.032"	0.250"

Nylon Insulated with Insulation Grip Male Disconnect

Terminal Type Disconnect
 Terminal Style Standard
 Fastener Orientation Male
 Insulation Material Nylon
 Barrel Style Insulation Grip
 RoHS 2011/65/EU Yes
 Agency Approval 
 Manufacturing Origin  With U.S. and Global Content

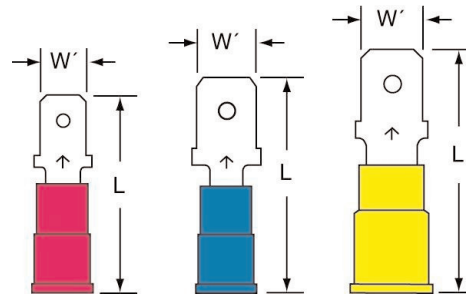

Product No.	UPC	Conductor Size	Male Tab Width (W')	(L)	Thickness	Barrel I.D.	Max. Insul. Dia.
71M-187-20-NB	054007-30121	22 - 18 AWG	0.187"	0.84"	0.020"	0.080"	0.145"
71M-250-32-NB	054007-30114	22 - 18 AWG	0.250"	0.92"	0.032"	0.065"	0.145"
72M-187-20-NB	054007-29230	16 - 14 AWG	0.187"	0.84"	0.020"	0.080"	0.145"
72M-250-32-NB	054007-29231	16 - 14 AWG	0.250"	0.94"	0.032"	0.085"	0.170"
73M-250-32-NB	054007-29232	12 - 10 AWG	0.250"	1.05"	0.032"	0.150"	0.250"

Specialty Wire Terminals, Kits and Tools

3M™ Terminals: 3M™ Male Disconnects

Nylon Insulated with Insulation Grip Bullet Style Male Disconnect

Terminal Type	Disconnect
Terminal Style	Bullet Snap Plug
Fastener Orientation	Male
Insulation Material	Nylon
Barrel Style	Insulation Grip
RoHS 2011/65/EU	Yes
Manufacturing Origin	Taiwan

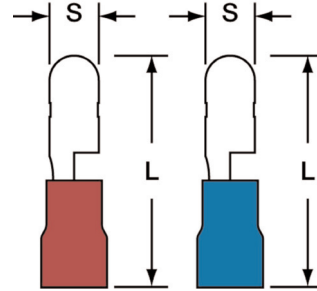

Product No.	UPC	Conductor Size	Mating Snap Diameter (S)	(L)	Max. Insul. Dia.
81M-156-NB-A	051138-98087	22 - 18 AWG	0.156"	0.87"	0.150"
81M-180-NB-A	051138-98099	22 - 18 AWG	0.180"	0.87"	0.150"
82M-156-NB-A	051138-98136	16 - 14 AWG	0.156"	0.87"	0.190"
82M-180-NB-A	051138-98154	16 - 14 AWG	0.180"	0.87"	0.170"

3M™ Terminals: 3M™ Piggy-Back Disconnects

Non-Insulated Butted Seam Multi-Stack Disconnect

Terminal Type	Disconnect
Terminal Style	Multi-Stack
Fastener Orientation	Male-Female
Insulation Material	Non-Insulated
Barrel Style	Butted
RoHS 2011/65/EU	Yes
Manufacturing Origin	Taiwan

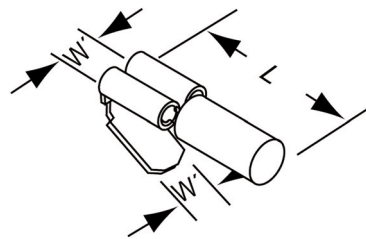

Product No.	UPC	Conductor Size	Mating Snap Diameter (S)	Thickness	(L)	Barrel I.D.
772-250-A	054007-29955	16 - 14 AWG	0.250"	0.032"	0.66"	0.090"

3M™ Terminals: 3M™ Piggy-Back Disconnects

Vinyl Insulated Butted Seam Piggy-Back Disconnect

Terminal Type	Disconnect
Terminal Style	Piggy-Back
Fastener Orientation	Male-Female
Insulation Material	Vinyl
Barrel Style	Butted
RoHS 2011/65/EU	Yes
Manufacturing Origin	Taiwan

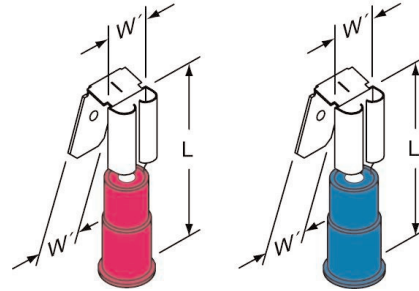

Product No.	UPC	Conductor Size	Mates with Male Tab Width (W')	(L)	Thickness	Barrel Length	Barrel I.D.	Max. Insul. Dia.
771-250-P-A	051138-98061	22 - 18 AWG	0.250"	0.87"	0.032"	0.23"	0.070"	0.150"
772-250-P-A	051138-98072	16 - 14 AWG	0.250"	0.87"	0.032"	0.23"	0.090"	0.170"

Nylon Insulated with Insulation Grip Piggy-Back Disconnect

Terminal Type	Disconnect
Terminal Style	Piggy-Back
Fastener Orientation	Male-Female
Insulation Material	Nylon
Barrel Style	Insulation Grip
RoHS 2011/65/EU	Yes
Manufacturing Origin	Taiwan

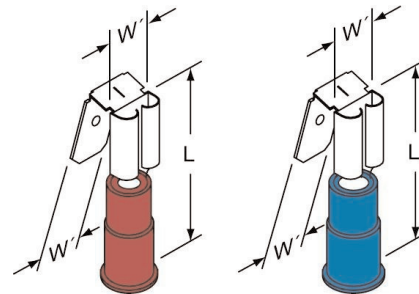

Product No.	UPC	Conductor Size	Mates with Male Tab Width (W')	(L)	Thickness	Max. Insul. Dia.
771-250-NB-A	051138-98057	22 - 18 AWG	0.250"	0.91"	0.032"	0.150"
772-250-NB-A	051138-98066	16 - 14 AWG	0.250"	0.91"	0.032"	0.190"

Specialty Wire Terminals, Kits and Tools

3M™ Terminals: 3M™ Adapters

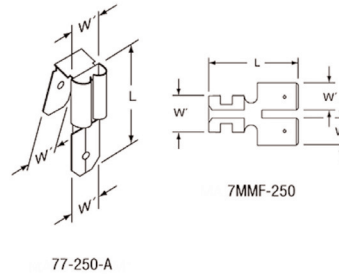

Non-Insulated Double Male-Female Adapter

Terminal Type	Disconnect
Terminal Style	Adapter
Fastener Orientation	Double Male-Female
Insulation Material	Non-Insulated
Barrel Style	Butted
RoHS 2011/65/EU	Yes
Agency Approval	 Except for 77-250-A Adapters
Manufacturing Origin	Taiwan



Product No.	UPC	Mates with Female and Male Tab Width (W')	(L)	Thickness
77-250-A	051128-57424	0.250"	0.70"	0.032"
7MMF-250	054007-29955	0.250"	0.76"	0.032"

Non-Insulated Fuse-Clip Disconnect Adapter

Terminal Type	Disconnect
Terminal Style	Fuse-clip
Fastener Orientation	Male
Insulation Material	Non-Insulated
Barrel Style	NA
RoHS 2011/65/EU	Yes
Agency Approval	
Manufacturing Origin	

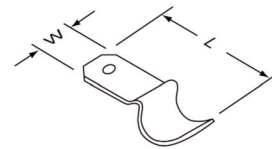

Product No.	UPC	Male Tab Width (W')	(L)	Thickness
7M-250	054007-30095	0.250"	0.77"	0.030"

Specialty Wire Terminals, Kits and Tools

3M™ Terminals: 3M™ High Temperature Terminals

Butted Seam 900°F (482°C) High Temperature Ring Tongue

Terminal Type	Ring
Terminal Style	High Temperature
Insulation Material	Non-Insulated
Barrel Style	Butted
RoHS 2011/65/EU	Yes
Manufacturing Origin	

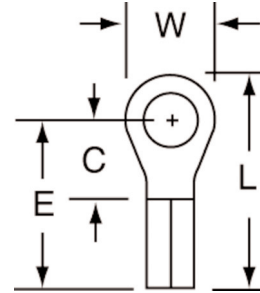

Product No.	UPC	Conductor Size	Stud Size	(W)	(C)	(L)	(E)	Thickness	Barrel I.D.
HT-11-6S	054007-29353	22 - 18 AWG	6	0.25"	0.22"	0.60"	0.47"	0.030"	0.070"
HT-11-10	054007-29354	22 - 18 AWG	10	0.33"	0.29"	0.70"	0.54"	0.030"	0.070"
HT-11-14	054007-29355	22 - 18 AWG	1/4"	0.56"	0.40"	0.93"	0.65"	0.030"	0.070"
HT-12-6S	054007-29356	16 - 14 AWG	6	0.25"	0.22"	0.60"	0.47"	0.030"	0.090"
HT-12-10	054007-29357	16 - 14 AWG	10	0.33"	0.29"	0.70"	0.54"	0.030"	0.090"
HT-12-14	054007-29358	16 - 14 AWG	1/4"	0.56"	0.40"	0.93"	0.65"	0.030"	0.090"
HT-13-6	054007-29359	12 - 10 AWG	6	0.38"	0.29"	0.73"	0.54"	0.040"	0.135"
HT-13-10	054007-29360	12 - 10 AWG	10	0.38"	0.29"	0.73"	0.54"	0.040"	0.135"
HT-13-14	054007-29361	12 - 10 AWG	1/4"	0.59"	0.44"	0.99"	0.69"	0.040"	0.135"
HT-13-38	054007-29362	12 - 10 AWG	3/8"	0.61"	0.44"	0.99"	0.69"	0.040"	0.135"
HT-14-14S	054007-29363	8 AWG	1/4"	0.47"	0.40"	0.95"	0.71"	0.050"	0.185"
HT-15-38	054007-29364	6 AWG	3/8"	0.63"	0.52"	1.22"	0.91"	0.050"	0.255"
HT-16-38	054007-29365	4 AWG	3/8"	0.68"	0.53"	1.34"	1.00"	0.075"	0.285"

Butted Seam 900°F (482°C) High Temperature Standard Fork

Terminal Type	Fork
Terminal Style	High Temperature
Insulation Material	Non-Insulated
Barrel Style	Butted
RoHS 2011/65/EU	Yes
Manufacturing Origin	

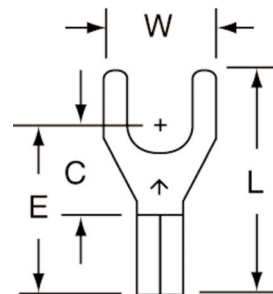

Product No.	UPC	Conductor Size	Stud Size	(W)	(C)	(L)	(E)	Thickness	Barrel I.D.
HT-31-10	054007-29612	22 - 18 AWG	10	0.34"	0.29"	0.70"	0.54"	0.030"	0.070"
HT-32-10	054007-29613	16 - 14 AWG	10	0.34"	0.29"	0.70"	0.54"	0.030"	0.090"
HT-33-10	054007-29600	12 - 10 AWG	10	0.38"	0.28"	0.73"	0.53"	0.040"	0.135"

Specialty Wire Terminals, Kits and Tools

3M™ Terminals: 3M™ High Temperature Terminals

Butted Seam 900°F (482°C) High Temperature Block Fork

Terminal Type	Fork
Terminal Style	High Temperature Block
Insulation Material	Non-Insulated
Barrel Style	Butted
RoHS 2011/65/EU	Yes
Manufacturing Origin	

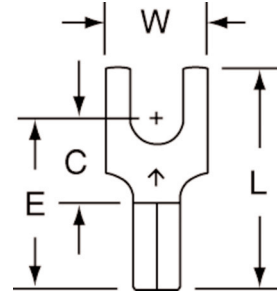

Product No.	UPC	Conductor Size	Stud Size	(W)	(C)	(L)	(E)	Thickness	Barrel I.D.
HT-BS-31-6	054007-29601	22 - 18 AWG	6	0.30"	0.25"	0.65"	0.50"	0.030"	0.070"
HT-BS-32-6	054007-29602	16 - 14 AWG	6	0.30"	0.25"	0.65"	0.50"	0.030"	0.090"

Butted Seam 900°F (482°C) High Temperature Butt Connector

Terminal Type	Butt
Terminal Style	High Temperature
Insulation Material	Non-Insulated
Barrel Style	Butted
RoHS 2011/65/EU	Yes
Manufacturing Origin	

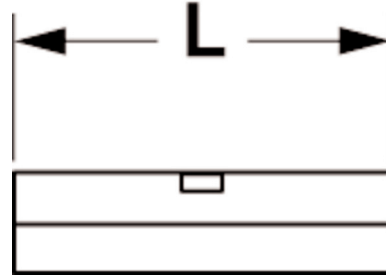

Product No.	UPC	Conductor Size	(L)	Thickness	Barrel Length	Barrel I.D.
HT-61	054007-29366	22 - 18 AWG	0.56"	0.030"	0.25"	0.070"
HT-62	054007-29367	16 - 14 AWG	0.56"	0.030"	0.25"	0.090"
HT-63	054007-29368	12 - 10 AWG	0.56"	0.040"	0.25"	0.135"

Specialty Wire Terminals, Kits and Tools

3M™ Terminals: 3M™ High Temperature Terminals

Butted Seam 900°F (482°C) High Temperature Female Disconnect

Terminal Type Disconnect
 Terminal Style High Temperature
 Fastener Orientation Female
 Insulation Material Non-Insulated
 Barrel Style Butted
 RoHS 2011/65/EU Yes

Manufacturing Origin  Product numbers ending with "-A" are made in Taiwan

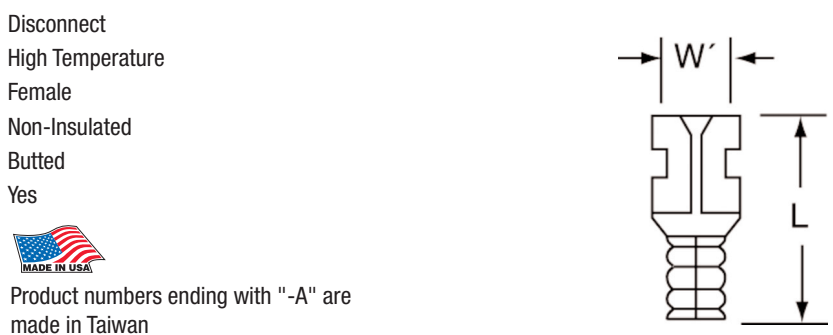

Product No.	UPC	Conductor Size	Mates with Male Tab Width (W')	(L)	Thickness	Barrel Length	Barrel I.D.
HT-72F-187-20	054007-29369	16 - 14 AWG	0.187"	0.58"	0.020"	0.25"	0.085"
HT-72F-250-32	054007-29370	16 - 14 AWG	0.250"	0.64"	0.032"	0.23"	0.095"
HT-73F-250-32-A	054007-49568	12 - 10 AWG	0.250"	0.64"	0.032"	0.23"	0.140"

Butted Seam 900°F (482°C) High Temperature Male Disconnect

Terminal Type Disconnect
 Terminal Style High Temperature
 Fastener Orientation Male
 Insulation Material Non-Insulated
 Barrel Style Butted
 RoHS 2011/65/EU Yes

Manufacturing Origin  Product numbers ending with "-A" are made in Taiwan



Product No.	UPC	Conductor Size	Male Tab Width (W')	(L)	Thickness	Barrel Length	Barrel I.D.
HT-72M-187-20	054007-29371	16 - 14 AWG	0.187"	0.64"	0.020"	0.24"	0.080"
HT-72M-250-32	054007-29372	16 - 14 AWG	0.250"	0.73"	0.032"	0.25"	0.090"

Specialty Wire Terminals, Kits and Tools

3M™ Terminals: 3M™ High Temperature Terminals

Butted Seam 900°F (482°C) High Temperature Female Flag Disconnect

Terminal Type	Disconnect
Terminal Style	High Temperature
Fastener Orientation	Female Flag
Insulation Material	Non-Insulated
Barrel Style	Butted
RoHS 2011/65/EU	Yes
Manufacturing Origin	

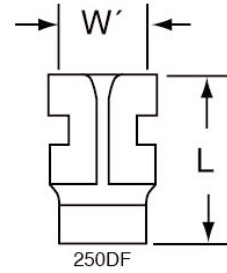

Product No.	UPC	Conductor Size	Mates with Male Tab Width (W')	(L)	Thickness	Barrel Length	Barrel I.D.
HT-752-250-32	054007-29478	16 - 14 AWG	0.250"	0.51"	0.032"	0.26"	0.095"

3M™ Terminals: 3M™ Pin Terminals

Vinyl Insulated Butted Seam Pin Terminal

Terminal Type	Pin
Insulation Material	Vinyl
Barrel Style	Butted
RoHS 2011/65/EU	Yes
Manufacturing Origin	Taiwan

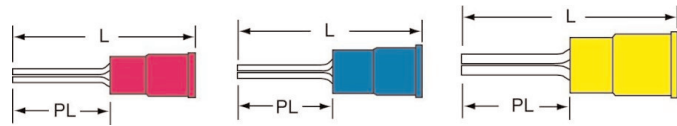

Product No.	UPC	Conductor Size	(L)	Max. Insul. Dia.	Pin Length (PL)	Pin Diameter
81P-47-P-A	051138-98110	22 - 18 AWG	0.90"	0.150"	0.47"	0.075"
82P-47-P-A	051138-98170	16 - 14 AWG	0.90"	0.170"	0.47"	0.075"
83P-55-P-A	051138-98181	12 - 10 AWG	1.06"	0.250"	0.55"	0.110"

Nylon Insulated with Insulation Grip Pin Terminal

Terminal Type	Pin
Insulation Material	Nylon
Barrel Style	Insulation Grip
RoHS 2011/65/EU	Yes
Manufacturing Origin	Taiwan

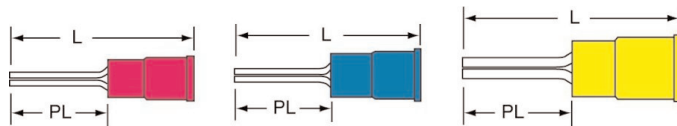

Product No.	UPC	Conductor Size	(L)	Pin Length (PL)	Pin Diameter	Max. Insul. Dia.
81P-47-NB-A	051138-98105	22 - 18 AWG	0.90"	0.47"	0.075"	0.170"
82P-47-NB-A	051138-98165	16 - 14 AWG	0.90"	0.47"	0.075"	0.200"
83P-55-NB-A	051138-98176	12 - 10 AWG	1.06"	0.55"	0.110"	0.270"

Specialty Wire Terminals, Kits and Tools

3M™ Terminals: 3M™ Closed End Connectors

Closed End Connector

3M™ Scotchlok™ Electrical Crimp Sleeve Connectors make fast work of splicing 22 to 10 AWG copper conductors. Smooth flared entry makes wire insertion fast – simply twist conductors together and crimp. The 722-N-A and 718-N-A connectors are insulated, closed-end crimp sleeve connectors with a copper insert. The rugged and resilient nylon insulator allows these connectors to be used in light fixtures, appliances and other electrical OEM applications.

Terminal Type	Closed End
Insulation Material	Nylon
Maximum Voltage	600 Volt
Maximum Operating Temperature (°F)	221 °F
Maximum Operating Temperature (°C)	105 °C
RoHS 2011/65/EU	Yes
Manufacturing Origin	Taiwan

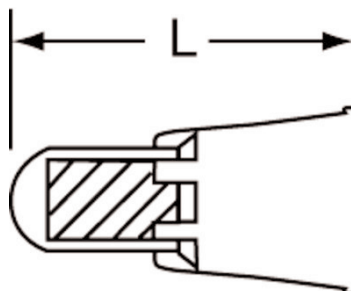

Product No.	UPC	Maximum Wire Gauge	Minimum Wire Gauge	(L)	Cu Solid/Stranded Wire Combinations
722-N-A	051138-98049	22 AWG	16 AWG	0.83"	2-5 #22; 1-4 #22 with 1-2 #20; 1-3 #22 with 1 #18; 1 #22 with 1 #16; 2-3 #20
718-N-A	051138-98042	18 AWG	10 AWG	1.00"	1 #22 with 1 #12 or #10; 1 #22 with 2 #14 or #16; 1 #22 with 1 #20 with 1 #12 or #14; 1 #22 with 1 #18 with 1 #12 or #14; 1 #22 with 1 #16 with 1 #12 or #14; 1 #22 with 1 #14 with 1 #12; 1-2 #20 with 1-2 #14; 1-2 #20 with 1 #12; 1 #20 with 1 #10; 1 #20 with 1 #16 with 1 #12; 1 #18 with 1 #14; 1 #18 with 1 #12; 1 #18 with 2 #16; 1 #18 with 1 #16 with 1 #12 or #14; 1 #16 with 1 #12 or #14; 3 #16; 1 #14 with 1 #12; 2 #14.

3M™ Terminals: 3M™ Parallel Connectors

Non-Insulated Butted Seam Parallel Connector

Terminal Type	Parallel Connector
Insulation Material	Non-Insulated
Barrel Style	Butted
RoHS 2011/65/EU	Yes
Manufacturing Origin	

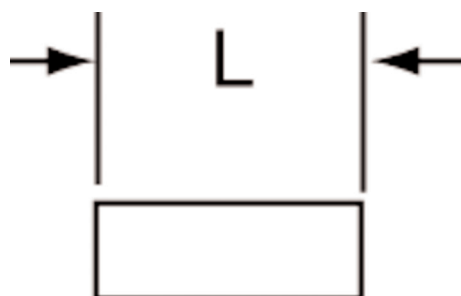

Product No.	UPC	Conductor Size	(L)	Thickness	Barrel I.D.	Max. Insul. Dia.	Cu Stranded Wire Combinations
91	054007-28264	22 - 18 AWG	0.31"	0.030"	0.070"	0.145"	1 #22 to 1 #22, 20, 18, 16; 1 #20 to 1 #20, 18, 16; 1 #18 to 1 #18
93	054007-28871	12 - 10 AWG	0.31"	0.040"	0.135"	0.250"	1 #18 to 1 #18, 16, 14, 12, 10; 1 #16 to 1 #16, 14, 12, 10; 1 #14 to 1 #14, 12

Specialty Wire Terminals, Kits and Tools

3M™ Terminals: 3M™ Parallel Connectors

Vinyl Insulated Butted Seam Parallel Connector

Terminal Type Parallel Connector
 Insulation Material Vinyl
 Barrel Style Butted
 RoHS 2011/65/EU Yes
 Manufacturing Origin 

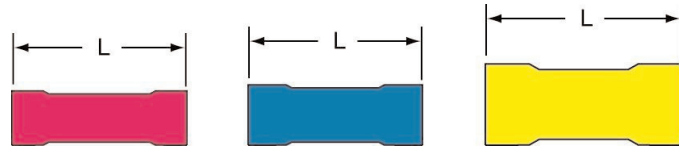

Product No.	UPC	Conductor Size (L)	Thickness	Barrel I.D.	Max. Insul. Dia.	Cu Stranded Wire Combinations	
91-P	054007-28263	22 - 18 AWG	0.67"	0.030"	0.070"	0.145"	1 #22 to 1 #22, 20, 18, 16; 1 #20 to 1 #20, 18, 16; 1 #18 to 1 #18
92-P	054007-28661	16 - 14 AWG	0.67"	0.030"	0.090"	0.170"	1 #22 to 1 #22, 20, 18, 16, 14; 1 #20 to 1 #20, 18, 16, 14; 1 #18 to 1 #18, 16, 14; 1 #16 to 1 #16
93-P	054007-28870	12 - 10 AWG	0.87"	0.040"	0.135"	0.250"	1 #18 to 1 #18, 16, 14, 12, 10; 1 #16 to 1 #16, 14, 12, 10; 1 #14 to 1 #14, 12

Specialty Wire Terminals, Kits and Tools

3M™ Highland™ Terminals

3M Highland terminals, disconnects, and connectors are for use in the assembly and maintenance of electrical systems. 3M Highland terminals offer effective and reliable performance in a variety of types of general applications. Available in low quantity, reclosable bags, 3M Highland terminals are the optimal choice for smaller jobs.



Specialty Wire Terminals, Kits and Tools

Section	Page
3M™ Highland™ Terminals	59-64
3M™ Highland™ Ring Tongues.....	60
3M™ Highland™ Standard Forks.....	61
3M™ Highland™ Block Forks	61
3M™ Highland™ Locking Forks.....	62
3M™ Highland™ Butt Splices.....	62
3M™ Highland™ Female Disconnects	63
3M™ Highland™ Male Disconnects.....	64

3M™ Highland™ Terminals: 3M™ Highland™ Ring Tongues

Vinyl Insulated Butted Seam – Ring Tongues

Terminal Type Ring
 Terminal Style Standard
 Insulation Material Vinyl
 Barrel Style Butted
 RoHS 2011/65/EU Yes
 Agency Approval 
 Manufacturing Origin 

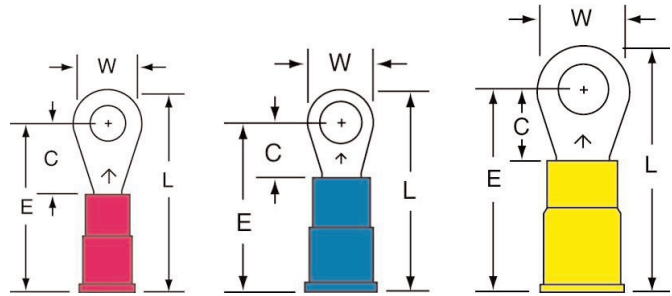



Product No.	UPC	Conductor Size	Stud Size	Terminals per Bag
RV18-6Q	051128-60045	22 - 18 AWG	6	25
RV18-10Q	051128-60043	22 - 18 AWG	10	25
RV18-8Q	051128-60046	22 - 18 AWG	8	25
RV18-14Q	051128-60044	22 - 18 AWG	1/4"	25
RV14-6Q	051128-60041	16 - 14 AWG	6	25
RV14-10Q	051128-60038	16 - 14 AWG	10	25
RV14-8Q	051128-60042	16 - 14 AWG	8	25
RV14-14Q	051128-60039	16 - 14 AWG	1/4"	25
RV14-516Q	051128-60040	16 - 14 AWG	5/16"	25
RV10-10Q	051128-60032	12 - 10 AWG	10	25
RV10-6Q	051128-60036	12 - 10 AWG	6	25
RV10-8Q	051128-60037	12 - 10 AWG	8	25
RV10-14Q	051128-60033	12 - 10 AWG	1/4"	25
RV10-516Q	051128-60035	12 - 10 AWG	5/16"	25
RV10-38Q	051128-60034	12 - 10 AWG	3/8"	25

Specialty Wire Terminals, Kits and Tools

3M™ Highland™ Terminals: 3M™ Highland™ Standard Forks

Vinyl Insulated Butted Seam – Standard Forks

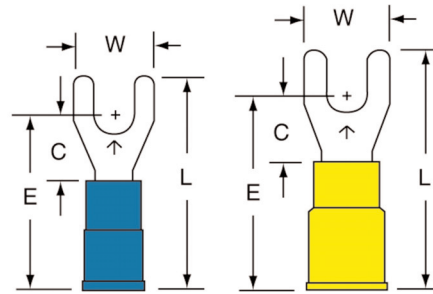

Terminal Type Fork
Terminal Style Standard
Insulation Material Vinyl
Barrel Style Butted
RoHS 2011/65/EU Yes
Agency Approval 
Manufacturing Origin 



Product No.	UPC	Conductor Size	Stud Size	Terminals per Bag
FV14-6Q	051128-60012	16 - 14 AWG	6	25
FV14-8Q	051128-60013	16 - 14 AWG	8	25
FV14-10Q	051128-60011	16 - 14 AWG	10	25
FV10-8Q	051128-60010	12 - 10 AWG	8	25
FV10-10Q	051128-60009	12 - 10 AWG	10	25

3M™ Highland™ Terminals: 3M™ Highland™ Block Forks

Vinyl Insulated Butted Seam – Block Forks

Terminal Type Fork
Terminal Style Block
Insulation Material Vinyl
Barrel Style Butted
RoHS 2011/65/EU Yes
Agency Approval 
Manufacturing Origin 

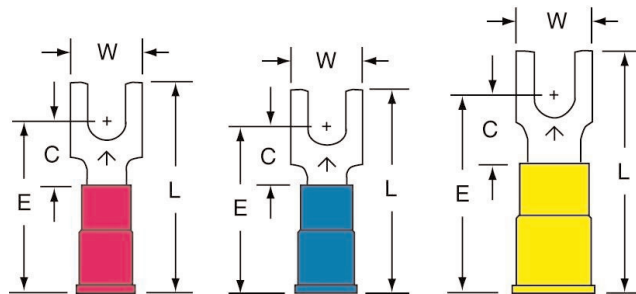



Product No.	UPC	Conductor Size	Stud Size	Terminals per Bag
BFV18-6Q	051128-59994	22 - 18 AWG	6	25
BFV18-8Q	051128-59995	22 - 18 AWG	8	25
BFV18-10Q	051128-59993	22 - 18 AWG	10	25
BFV14-6Q	051128-59991	16 - 14 AWG	6	25
BFV14-8Q	051128-59992	16 - 14 AWG	8	25
BFV14-10Q	051128-59990	16 - 14 AWG	10	25
BFV10-6Q	051128-59988	12 - 10 AWG	6	25
BFV10-8Q	051128-59989	12 - 10 AWG	8	25
BFV10-10Q	051128-59987	12 - 10 AWG	10	25

Specialty Wire Terminals, Kits and Tools

3M™ Highland™ Terminals: 3M™ Highland™ Locking Forks

Vinyl Insulated Butted Seam – Locking Forks

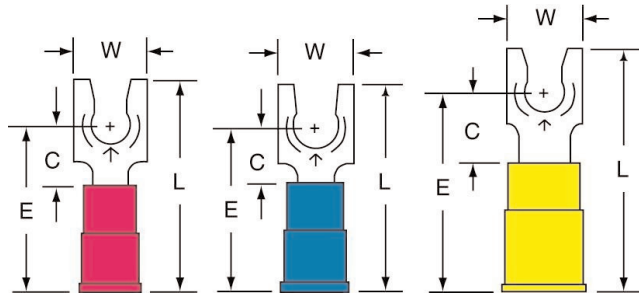

Terminal Type Fork
 Terminal Style Locking
 Insulation Material Vinyl
 Barrel Style Butted
 RoHS 2011/65/EU Yes
 Agency Approval 
 Manufacturing Origin 



Product No.	UPC	Conductor Size	Stud Size	Terminals per Bag
LFV18-6Q	051128-60020	22 - 18 AWG	6	25
LFV18-8Q	051128-60021	22 - 18 AWG	8	25
LFV14-6Q	051128-60018	16 - 14 AWG	6	25
LFV14-8Q	051128-60019	16 - 14 AWG	8	25
LFV14-10Q	051128-60017	16 - 14 AWG	10	25
LFV10-6Q	051128-60015	12 - 10 AWG	6	25
LFV10-8Q	051128-60016	12 - 10 AWG	8	25
LFV10-10Q	051128-60014	12 - 10 AWG	10	25

3M™ Highland™ Terminals: 3M™ Highland™ Butt Splices

Vinyl Insulated Butted Seam – Butt Splices

Terminal Type Butt
 Terminal Style Standard
 Insulation Material Vinyl
 Barrel Style Butted
 RoHS 2011/65/EU Yes
 Agency Approval 
 Manufacturing Origin 

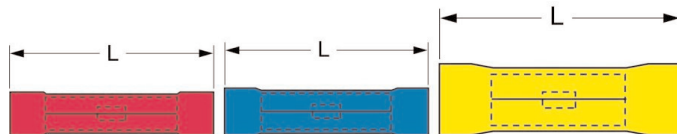



Product No.	UPC	Conductor Size	Terminals per Bag
BSV18Q	051128-59998	22 - 18 AWG	25
BSV14Q	051128-59997	16 - 14 AWG	25
BSV10Q	051128-59996	12 - 10 AWG	25

Specialty Wire Terminals, Kits and Tools

3M™ Highland™ Terminals: 3M™ Highland™ Female Disconnects

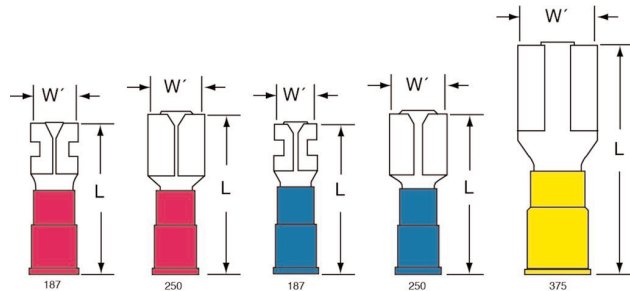

Vinyl Insulated Butted Seam – Female Disconnects

Terminal Type Disconnect
 Terminal Style Standard
 Fastener Orientation Female
 Insulation Material Vinyl
 Barrel Style Butted
 RoHS 2011/65/EU Yes
 Agency Approval 
 Manufacturing Origin 



Product No.	UPC	Conductor Size	Mates with Male Tab Width (W')	Terminals per Bag
FDV18-187Q	051128-60007	22 - 18 AWG	0.187"	25
FDV18-250Q	051128-60008	22 - 18 AWG	0.250"	25
FDV14-187Q	051128-60005	16 - 14 AWG	0.187"	25
FDV14-250Q	051128-60006	16 - 14 AWG	0.250"	25
FDV10-250Q	051128-60004	12 - 10 AWG	0.250"	25

Nylon Fully Insulated Butted Seam – Female Disconnects

Terminal Type Disconnect
 Terminal Style Fully Insulated
 Fastener Orientation Female
 Insulation Material Nylon
 Barrel Style Butted
 RoHS 2011/65/EU Yes
 Agency Approval 
 Manufacturing Origin 

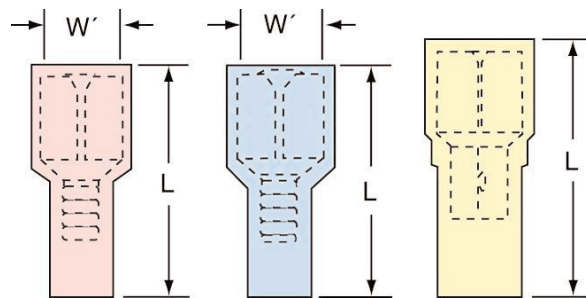



Product No.	UPC	Conductor Size	Mates with Male Tab Width (W')	Terminals per Bag
FDI18-187Q	051128-60002	22 - 18 AWG	0.187"	25
FDI18-250Q	051128-60003	22 - 18 AWG	0.250"	25
FDI14-187Q	051128-60000	16 - 14 AWG	0.187"	25
FDI14-250Q	051128-60001	16 - 14 AWG	0.250"	25
FDI10-250Q	051128-59999	12 - 10 AWG	0.250"	25

Specialty Wire Terminals, Kits and Tools

3M™ Highland™ Terminals: 3M™ Highland™ Male Disconnects

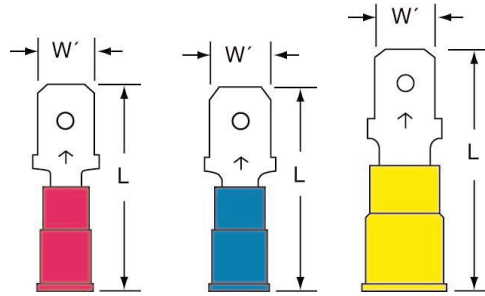

Vinyl Insulated Butted Seam – Male Disconnects

Terminal Type Disconnect
 Terminal Style Standard
 Fastener Orientation Male
 Insulation Material Vinyl
 Barrel Style Butted
 RoHS 2011/65/EU Yes
 Agency Approval 
 Manufacturing Origin 



Product No.	UPC	Conductor Size	Mates with Male Tab Width (W')	Terminals per Bag
MTV18-187Q	051128-60030	22 - 18 AWG	0.187"	25
MTV18-250Q	051128-60031	22 - 18 AWG	0.250"	25
MTV14-187Q	051128-60028	16 - 14 AWG	0.187"	25
MTV14-250Q	051128-60029	16 - 14 AWG	0.250"	25
MTV10-250Q	051128-60027	12 - 10 AWG	0.250"	25

Nylon Fully Insulated Butted Seam – Male Disconnects

Terminal Type Disconnect
 Terminal Style Fully Insulated
 Fastener Orientation Male
 Insulation Material Nylon
 Barrel Style Butted
 RoHS 2011/65/EU Yes
 Agency Approval 
 Manufacturing Origin 

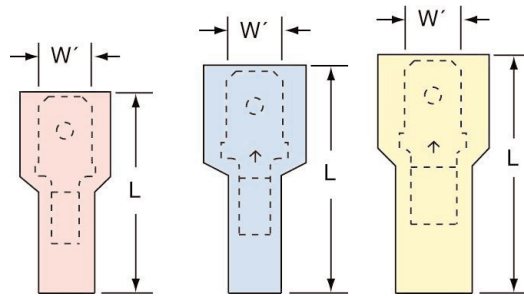

Product No.	UPC	Conductor Size	Mates with Male Tab Width (W')	Terminals per Bag
MTI18-187Q	051128-60025	22 - 18 AWG	0.187"	25
MTI18-250Q	051128-60026	22 - 18 AWG	0.250"	25
MTI14-187Q	051128-60023	16 - 14 AWG	0.187"	25
MTI14-250Q	051128-60024	16 - 14 AWG	0.250"	25
MTI10-250Q	051128-60022	12 - 10 AWG	0.250"	25

Specialty Wire Terminals, Kits and Tools

3M™ Specialty Bagged Terminals

3M specialty bagged terminals, disconnects, and connectors are for use in the assembly and maintenance of electrical systems. 3M terminals offer effective and reliable performance in a variety of types of general applications.



Specialty Wire Terminals, Kits and Tools

Section	Page
3M™ Specialty Bagged Terminals	65-82
3M™ Closed End Connectors	66
3M™ Butt Connectors.....	66-68
3M™ Female Disconnects	69-71
3M™ Male Disconnects	72-74
3M™ Ring Tongues.....	74-78
3M™ Locking Forks.....	79-80
3M™ Block Forks.....	81
3M™ Standard Forks	82

3M™ Specialty Bagged Terminals: 3M™ Closed End Connectors

Closed End Connector, Bag

Terminal Type	Closed End
Insulation Material	Nylon
Maximum Voltage	600 Volt
Maximum Operating Temperature (°F)	221 °F
Maximum Operating Temperature (°C)	105 °C
Manufacturing Origin	Taiwan

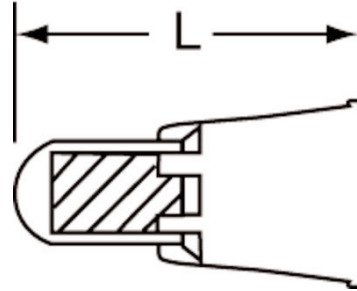

Product No.	UPC	Description	Maximum Wire Gauge	Minimum Wire Gauge	(L)	Cu Solid/Stranded Wire Combinations	Qty./Bag
94813-A	051138-98056	722-N-A	22 AWG	16 AWG	0.83"	2-5 #22; 1-4 #22 with 1-2 #20; 1-3 #22 with 1 #18; 1 #22 with 1 #16; 2-3 #20	50
94796-A	051138-98048	718-N-A	18 AWG	10 AWG	1.00"	1 #22 with 1 #12 or #10; 1 #22 with 2 #14 or #16; 1 #22 with 1 #20 with 1 #12 or #14; 1 #22 with 1 #18 with 1 #12 or #14; 1 #22 with 1 #16 with 1 #12 or #14; 1 #22 with 1 #14 with 1 #12; 1-2 #20 with 1-2 #14; 1-2 #20 with 1 #12; 1 #20 with 1 #10; 1 #20 with 1 #16 with 1 #12; 1 #18 with 1 #14; 1 #18 with 1 #12; 1 #18 with 2 #16; 1 #18 with 1 #16 with 1 #12 or #14; 1 #16 with 1 #12 or #14; 3 #16; 1 #14 with 1 #12; 2 #14.	50

3M™ Specialty Bagged Terminals: 3M™ Butt Connectors

Vinyl Insulated Butted Seam Butt Connector, Bag

Terminal Type	Butt
Terminal Style	Standard
Insulation Material	Vinyl
Barrel Style	Butted
RoHS 2011/65/EU	Yes
Agency Approval	
Manufacturing Origin	

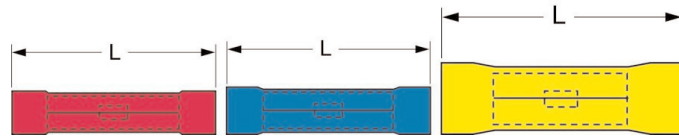





Product No.	UPC	Description	Conductor Size	(L)	Thickness	Barrel Length	Barrel I.D.	Max. Insul. Dia.	Qty./Bag
94785	054007-94785	61-P	22 - 18 AWG	1.00"	0.030"	0.25"	0.070"	0.145"	100
94788	054007-94788	62-P	16 - 14 AWG	1.00"	0.030"	0.25"	0.090"	0.170"	100
94791	054007-94791	63-P	12 - 10 AWG	1.02"	0.040"	0.25"	0.135"	0.250"	50

Specialty Wire Terminals, Kits and Tools

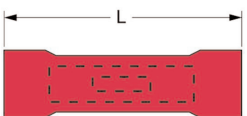
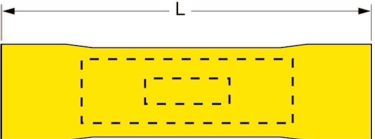



3M™ Specialty Bagged Terminals: 3M™ Butt Connectors

Vinyl Insulated Brazed Seam Butt Connector, Bag

Terminal Type	Butt		
Terminal Style	Standard		
Insulation Material	Vinyl		
Barrel Style	Brazed		
RoHS 2011/65/EU	Yes		
Agency Approval	 		
Manufacturing Origin			

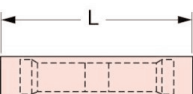
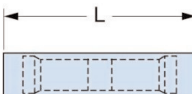
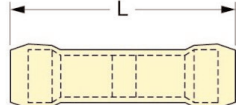
Product No.	UPC	Description	Conductor Size	(L)	Thickness	Barrel Length	Barrel I.D.	Max. Insul. Dia.	Qty./Bag
94793	054007-94793	64-WP	8 AWG	1.50"	0.050"	0.38"	0.175"	0.300"	25
94795	054007-94795	66-WP	4 AWG	2.17"	0.075"	0.53"	0.280"	0.480"	15

Nylon Insulated with Insulation Grip Butt Connector, Bag



Terminal Type	Butt			
Terminal Style	Standard			
Insulation Material	Nylon with Insulation Grip			
Barrel Style	Butted			
RoHS 2011/65/EU	Yes			
Agency Approval	 			
Manufacturing Origin				

Product No.	UPC	Description	Conductor Size	(L)	Thickness	Barrel Length	Barrel I.D.	Max. Insul. Dia.	Qty./Bag
94784	054007-94784	61-NB	22 - 18 AWG	1.00"	0.030"	0.25"	0.070"	0.145"	100
94787	054007-94787	62-NB	16 - 14 AWG	1.00"	0.030"	0.25"	0.090"	0.170"	100
94790	054007-94790	63-NB	12 - 10 AWG	1.15"	0.040"	0.25"	0.135"	0.250"	50

Specialty Wire Terminals, Kits and Tools

3M™ Specialty Bagged Terminals: 3M™ Butt Connectors

Nylon Insulated Seamless Butt Connector, Bag

Terminal Type	Butt
Terminal Style	Standard
Insulation Material	Nylon
Barrel Style	Seamless
RoHS 2011/65/EU	Yes
Agency Approval	 
Manufacturing Origin	Taiwan

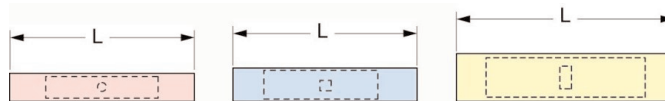

Product No.	UPC	Description	Conductor Size	(L)	Thickness	Barrel Length	Barrel I.D.	Max. Insul. Dia.	Qty./Bag
94786-A	054007-94786	61-SN-A	22 - 18 AWG	1.02"	0.031"	0.28"	0.062"	0.125"	100
94789-A	054007-94789	62-SN-A	16 - 14 AWG	1.02"	0.031"	0.30"	0.095"	0.155"	100
94792-A	054007-94792	63-SN-A	12 - 10 AWG	1.20"	0.038"	0.38"	0.142"	0.218"	50

Heat Shrink Nylon Insulated Seamless Butt Connector, Bag

Terminal Type	Butt
Terminal Style	Standard
Insulation Material	Heat Shrink
Barrel Style	Seamless
RoHS 2011/65/EU	Yes
Manufacturing Origin	

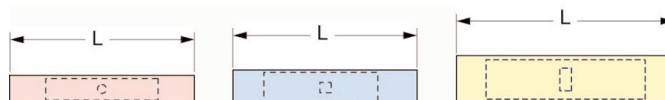

Product No.	UPC	Description	Conductor Size	(L)	Thickness	Barrel Length	Barrel I.D.	Max. Insul. Dia.	Qty./Bag
94861	054007-94861	MH18BCX	22 - 18 AWG	1.02"	0.031"	0.28"	0.062"	0.125"	25
94857	054007-94857	MH14BCX	16 - 14 AWG	1.02"	0.031"	0.30"	0.095"	0.155"	25
94850	054007-94850	MH10BCX	12 - 10 AWG	1.20"	0.038"	0.38"	0.142"	0.218"	25

Specialty Wire Terminals, Kits and Tools

3M™ Specialty Bagged Terminals: 3M™ Female Disconnects

Vinyl Insulated Butted Seam Female Disconnect, Bag

Terminal Type Disconnect
 Terminal Style Standard
 Fastener Orientation Female
 Insulation Material Vinyl
 Barrel Style Butted
 RoHS 2011/65/EU Yes

Agency Approval 

Manufacturing Origin 

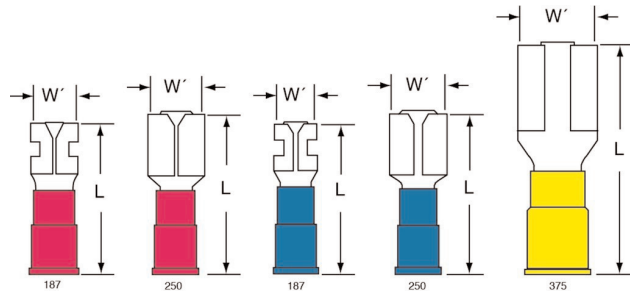

Product No.	UPC	Description	Conductor Size	Mates with Male Tab Width (W')	Thickness	(L)	Barrel I.D.	Max. Insul. Dia.	Qty./Bag
94800	054007-94800	71F-187-20-P	22 - 18 AWG	0.187"	0.020"	0.78"	0.085"	0.145"	100
94804	054007-94804	71F-250-32-P	22 - 18 AWG	0.250"	0.032"	0.87"	0.080"	0.145"	100
94817	054007-94817	72F-187-20-P	16 - 14 AWG	0.187"	0.020"	0.78"	0.085"	0.145"	100
94821	054007-94821	72F-250-32-P	16 - 14 AWG	0.250"	0.032"	0.87"	0.080"	0.145"	100
94833	054007-94833	73F-250-32-P	12 - 10 AWG	0.250"	0.032"	0.95"	0.165"	0.250"	50

Nylon Insulated with Insulation Grip Female Disconnect, Bag

Terminal Type Disconnect
 Terminal Style Standard
 Fastener Orientation Female
 Insulation Material Nylon with Insulation Grip
 Barrel Style Butted
 RoHS 2011/65/EU Yes

Agency Approval 
 Except for 110 & 375 Female Disconnects

Manufacturing Origin 

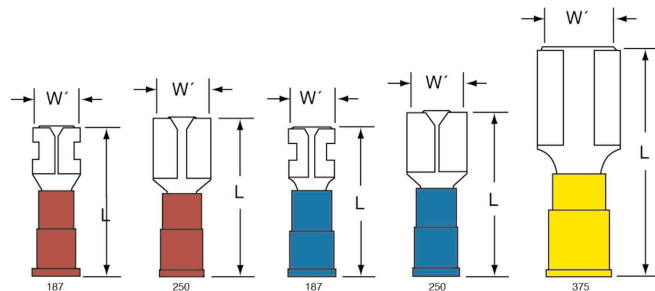

Product No.	UPC	Description	Conductor Size	Mates with Male Tab Width (W')	Thickness	(L)	Barrel I.D.	Max. Insul. Dia.	Qty./Bag
94797	054007-94797	71F-187-20-NB	22 - 18 AWG	0.187"	0.020"	0.77"	0.085"	0.145"	100
94801	054007-94801	71F-250-32-NB	22 - 18 AWG	0.250"	0.032"	0.86"	0.080"	0.145"	100
94814	054007-94814	72F-187-20-NB	16 - 14 AWG	0.187"	0.020"	0.77"	0.085"	0.145"	100
94818	054007-94818	72F-250-32-NB	16 - 14 AWG	0.250"	0.032"	0.86"	0.080"	0.145"	100
94830	054007-94830	73F-250-32-NB	12 - 10 AWG	0.250"	0.032"	0.94"	0.128"	0.250"	100

Specialty Wire Terminals, Kits and Tools

3M™ Specialty Bagged Terminals: 3M™ Female Disconnects

Nylon Fully Insulated with Insulation Grip Female Disconnect, Bag

Terminal Type Disconnect
 Terminal Style Fully Insulated
 Fastener Orientation Female
 Insulation Material Nylon with Insulation Grip
 Barrel Style Butted
 RoHS 2011/65/EU Yes
 Agency Approval 
 Manufacturing Origin 

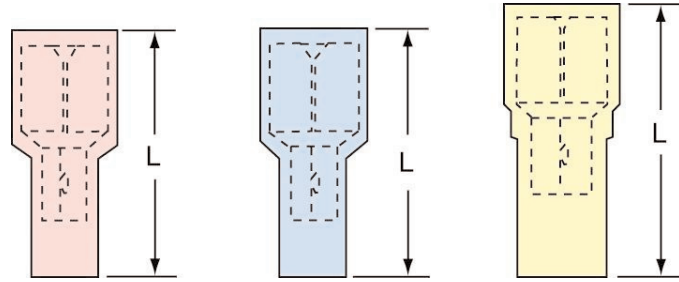

Product No.	UPC	Description	Conductor Size	Mates with Male Tab Width (W')	(L)	(W)	Diameter (D)	Thickness	Barrel I.D.	Max. Insul. Dia.	Qty./Bag
94798	054007-94798	71F-187-20-NBL	22 - 18 AWG	0.187"	0.81"	0.30"	0.23"	0.020"	0.085"	0.145"	100
94802	054007-94802	71F-250-32-NBL	22 - 18 AWG	0.250"	0.87"	0.37"	0.23"	0.032"	0.080"	0.145"	100
94815	054007-94815	72F-187-20-NBL	16 - 14 AWG	0.187"	0.81"	0.30"	0.23"	0.020"	0.085"	0.145"	100
94819	054007-94819	72F-250-32-NBL	16 - 14 AWG	0.250"	0.87"	0.37"	0.23"	0.032"	0.080"	0.145"	100
94831	054007-94831	73F-250-32-NBL	12 - 10 AWG	0.250"	0.99"	0.39"	0.32"	0.032"	0.165"	0.250"	50

Nylon Insulated with Insulation Grip Bullet Style Female Disconnect, Bag

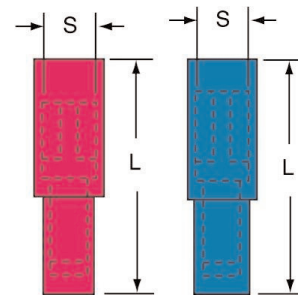

Terminal Type Disconnect
 Terminal Style Bullet Snap Plug
 Fastener Orientation Female
 Insulation Material Nylon with Insulation Grip
 Barrel Style Butted
 RoHS 2011/65/EU Yes
 Manufacturing Origin Taiwan



Product No.	UPC	Description	Conductor Size	Mating Snap Diameter (S)	(L)	Barrel I.D.	Max. Insul. Dia.	Qty./Bag
94838-A	051138-98082	81F-156-NBL-A	22 - 18 AWG	0.156"	0.99"	0.145"	0.150"	100
94839-A	051138-98086	81F-180-NBL-A	22 - 18 AWG	0.180"	1.00"	0.095"	0.150"	100
94842-A	051138-98125	82F-156-NBL-A	16 - 14 AWG	0.156"	0.99"	0.115"	0.190"	100

3M™ Specialty Bagged Terminals: 3M™ Female Disconnects

Nylon Fully Insulated Butted Seam Female Disconnect, Bag

Terminal Type Disconnect
Terminal Style Fully Insulated
Fastener Orientation Female
Insulation Material Nylon
Barrel Style Butted
RoHS 2011/65/EU Yes
Agency Approval 
Manufacturing Origin 

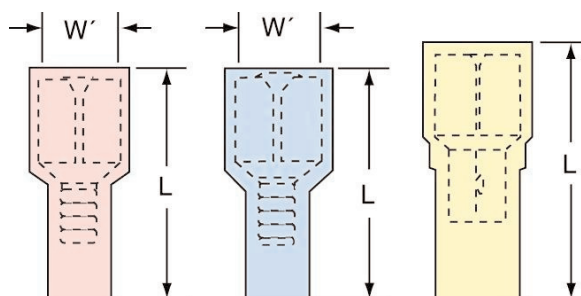

Product No.	UPC	Description	Conductor Size	Mates with Male Tab Width (W')	(W)	(L)	Diameter (D)	Thickness	Barrel I.D.	Max. Insul. Dia.	Qty./Bag
94799	054007-94799	71F-187-20-NL	22 - 18 AWG	0.187"	0.30"	0.81"	0.23"	0.020"	0.085"	0.145"	100
94803	054007-94803	71F-250-32-NL	22 - 18 AWG	0.250"	0.37"	0.87"	0.23"	0.032"	0.080"	0.145"	100
94816	054007-94816	72F-187-20-NL	16 - 14 AWG	0.187"	0.30"	0.81"	0.23"	0.020"	0.085"	0.145"	100
94820	054007-94820	72F-250-32-NL	16 - 14 AWG	0.250"	0.37"	0.87"	0.23"	0.032"	0.080"	0.145"	100
94832	054007-94832	73F-250-32-NL	12 - 10 AWG	0.250"	0.39"	0.99"	0.32"	0.032"	0.148"	0.250"	50

Nylon Insulated Butted Seam Bullet Style Female Disconnect, Bag

Terminal Type Disconnect
Terminal Style Bullet Snap Plug
Fastener Orientation Female
Insulation Material Nylon with Insulation Grip
Barrel Style Butted
RoHS 2011/65/EU Yes
Manufacturing Origin Taiwan

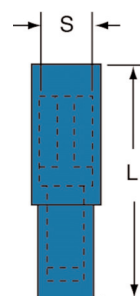

Product No.	UPC	Description	Conductor Size	Mating Snap Diameter (S)	(L)	Barrel I.D.	Max. Insul. Dia.	Qty./Bag
94843-A	051138-98134	82F-180-NL-A	16 - 14 AWG	0.180"	1.02"	0.115"	0.170"	100

Specialty Wire Terminals, Kits and Tools

3M™ Specialty Bagged Terminals: 3M™ Male Disconnects

Vinyl Insulated Butted Seam Male Disconnect, Bag

Terminal Type Disconnect
Terminal Style Standard
Fastener Orientation Male
Insulation Material Vinyl
Barrel Style Butted
RoHS 2011/65/EU Yes
Agency Approval 
Manufacturing Origin 

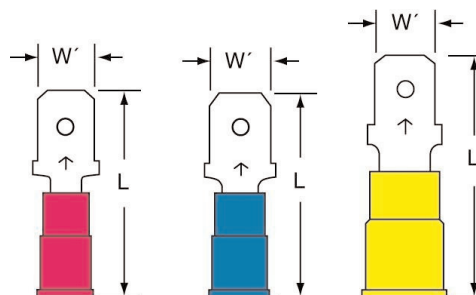

Product No.	UPC	Description	Conductor Size	Male Tab Width (W')	(L)	Thickness	Barrel I.D.	Max. Insul. Dia.	Qty./Bag
94808	054007-94808	71M-187-20-P	22 - 18 AWG	0.187"	0.85"	0.020"	0.080"	0.145"	100
94812	054007-94812	71M-250-32-P	22 - 18 AWG	0.250"	0.93"	0.032"	0.065"	0.145"	100
94825	054007-94825	72M-187-20-P	16 - 14 AWG	0.187"	0.85"	0.020"	0.080"	0.145"	100
94829	054007-94829	72M-250-32-P	16 - 14 AWG	0.250"	0.93"	0.032"	0.085"	0.170"	100
94837	054007-94837	73M-250-32-P	12 - 10 AWG	0.250"	1.05"	0.032"	0.150"	0.250"	50

Nylon Insulated with Insulation Grip Male Disconnect, Bag

Terminal Type Disconnect
Terminal Style Standard
Fastener Orientation Male
Insulation Material Nylon
Barrel Style Insulation Grip
RoHS 2011/65/EU Yes
Agency Approval 
Manufacturing Origin 

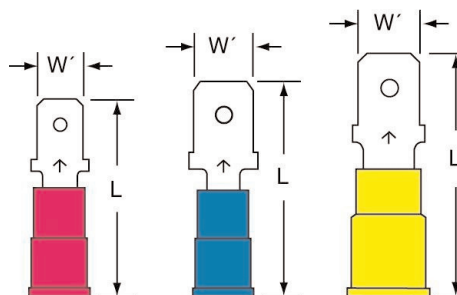

Product No.	UPC	Description	Conductor Size	Male Tab Width (W')	(L)	Thickness	Barrel I.D.	Max. Insul. Dia.	Qty./Bag
94805	054007-94805	71M-187-20-NB	22 - 18 AWG	0.187"	0.84"	0.020"	0.080"	0.145"	100
94809	054007-94809	71M-250-32-NB	22 - 18 AWG	0.250"	0.92"	0.032"	0.065"	0.145"	100
94822	054007-94822	72M-187-20-NB	16 - 14 AWG	0.187"	0.84"	0.020"	0.080"	0.145"	100
94826	054007-94826	72M-250-32-NB	16 - 14 AWG	0.250"	0.94"	0.032"	0.085"	0.170"	100
94834	054007-94834	73M-250-32-NB	12 - 10 AWG	0.250"	1.05"	0.032"	0.150"	0.250"	50

Specialty Wire Terminals, Kits and Tools

3M™ Specialty Bagged Terminals: 3M™ Male Disconnects

Nylon Insulated with Insulation Grip Bullet Style Male Disconnect, Bag

Terminal Type	Disconnect
Terminal Style	Bullet Snap Plug
Fastener Orientation	Male
Insulation Material	Nylon
Barrel Style	Insulation Grip
RoHS 2011/65/EU	Yes
Manufacturing Origin	Taiwan

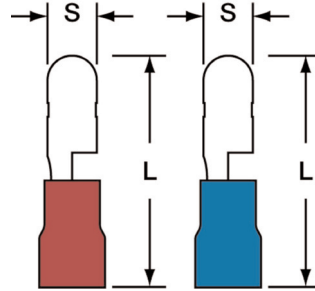

Product No.	UPC	Description	Conductor Size	Mating Snap Diameter (S)	(L)	Max. Insul. Dia.	Qty./Bag
94840-A	051138-98092	81M-156-NB-A	22 - 18 AWG	0.156"	0.87"	0.150"	100
94841-A	051138-98101	81M-180-NB-A	22 - 18 AWG	0.180"	0.87"	0.150"	100
94844-A	051138-98146	82M-156-NB-A	16 - 14 AWG	0.156"	0.87"	0.190"	100
94845-A	051138-98159	82M-180-NB-A	16 - 14 AWG	0.180"	0.87"	0.170"	100

Nylon Fully Insulated with Insulation Grip Male Disconnect, Bag

Terminal Type	Disconnect
Terminal Style	Fully Insulated
Fastener Orientation	Male
Insulation Material	Nylon with Insulation Grip
Barrel Style	Butted
RoHS 2011/65/EU	Yes
Agency Approval	
Manufacturing Origin	 MADE IN USA With U.S. and Global Content

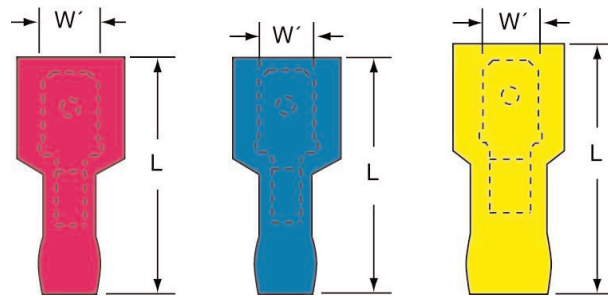



Product No.	UPC	Description	Conductor Size	Male Tab Width (W')	(L)	(W)	Diameter (D)	Thickness	Barrel I.D.	Qty./Bag
94806	054007-94806	71M-187-20-NBL	22 - 18 AWG	0.187"	0.87"	0.37"	0.30"	0.020"	0.145"	100
94810	054007-94810	71M-250-32-NBL	22 - 18 AWG	0.250"	0.95"	0.44"	0.30"	0.032"	0.145"	100
94823	054007-94823	72M-187-20-NBL	16 - 14 AWG	0.187"	0.87"	0.37"	0.30"	0.020"	0.145"	100
94827	054007-94827	72M-250-32-NBL	16 - 14 AWG	0.250"	0.95"	0.44"	0.30"	0.032"	0.170"	100
94835	054007-94835	73M-250-32-NBL	12 - 10 AWG	0.250"	1.05"	0.47"	0.39"	0.032"	0.250"	50

Specialty Wire Terminals, Kits and Tools

3M™ Specialty Bagged Terminals: 3M™ Male Disconnects

Nylon Fully Insulated Butted Seam Male Disconnect, Bag

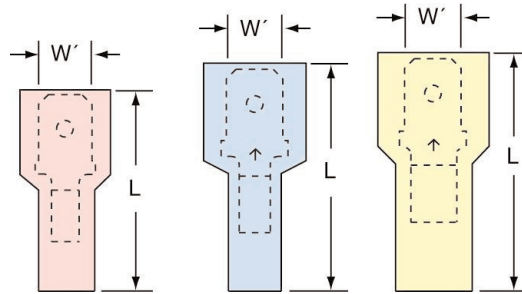

Terminal Type Disconnect
 Terminal Style Fully Insulated
 Fastener Orientation Male
 Insulation Material Nylon
 Barrel Style Butted
 RoHS 2011/65/EU Yes
 Agency Approval 
 Manufacturing Origin 



Product No.	UPC	Description	Conductor Size	Male Tab Width (W')	(L)	(W)	Diameter (D)	Thickness	Barrel I.D.	Max. Insul. Dia.	Qty./Bag
94807	054007-94807	71M-187-20-NL	22 - 18 AWG	0.187"	0.87"	0.37"	0.30"	0.020"	0.080"	0.145"	100
94811	054007-94811	71M-250-32-NL	22 - 18 AWG	0.250"	0.95"	0.44"	0.30"	0.032"	0.065"	0.145"	100
94824	054007-94824	72M-187-20-NL	16 - 14 AWG	0.187"	0.87"	0.37"	0.30"	0.020"	0.080"	0.145"	100
94828	054007-94828	72M-250-32-NL	16 - 14 AWG	0.250"	0.95"	0.44"	0.30"	0.032"	0.085"	0.170"	100
94836	054007-94836	73M-250-32-NL	12 - 10 AWG	0.250"	1.05"	0.47"	0.39"	0.032"	0.150"	0.250"	50

3M™ Specialty Bagged Terminals: 3M™ Ring Tongues

Vinyl Insulated Butted Seam Ring Tongue, Bag

Terminal Type Ring
 Terminal Style Standard
 Insulation Material Vinyl
 Barrel Style Butted
 RoHS 2011/65/EU Yes
 Agency Approval 
 Manufacturing Origin 

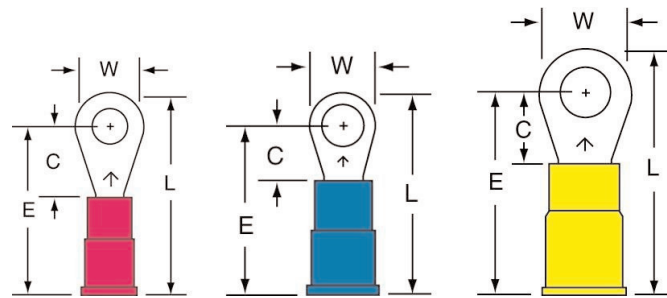

Product No.	UPC	Description	Conductor Size	Stud Size	(W)	(C)	(L)	(E)	Thickness	Barrel I.D.	Max. Insul. Dia.	Qty./Bag
94725	054007-94725	11-6S-P	22 - 18 AWG	6	0.25"	0.22"	0.80"	0.67"	0.030"	0.070"	0.145"	100
94727	054007-94727	11-8-P	22 - 18 AWG	8	0.33"	0.29"	0.90"	0.74"	0.030"	0.070"	0.145"	100
94717	054007-94717	11-10-P	22 - 18 AWG	10	0.33"	0.29"	0.90"	0.74"	0.030"	0.070"	0.145"	100
94719	054007-94719	11-14S-P	22 - 18 AWG	1/4"	0.47"	0.40"	1.08"	0.85"	0.030"	0.070"	0.145"	100
94736	054007-94736	12-6S-P	16 - 14 AWG	6	0.25"	0.22"	0.80"	0.67"	0.030"	0.070"	0.145"	100
94739	054007-94739	12-8-P	16 - 14 AWG	8	0.33"	0.29"	0.90"	0.74"	0.030"	0.070"	0.145"	100
94729	054007-94729	12-10-P	16 - 14 AWG	10	0.33"	0.29"	0.90"	0.74"	0.030"	0.070"	0.145"	100

Specialty Wire Terminals, Kits and Tools

3M™ Specialty Bagged Terminals: 3M™ Ring Tongues

Vinyl Insulated Butted Seam Ring Tongue, Bag (continued)

Product No.	UPC	Description	Conductor Size	Stud Size	(W)	(C)	(L)	(E)	Thickness	Barrel I.D.	Max. Insul. Dia.	Qty./Bag
94731	054007-94731	12-14S-P	16 - 14 AWG	1/4"	0.47"	0.40"	1.08"	0.85"	0.030"	0.070"	0.145"	100
94735	054007-94735	12-56S-P	16 - 14 AWG	5/16"	0.47"	0.40"	1.08"	0.85"	0.030"	0.070"	0.145"	100
94733	054007-94733	12-38-P	16 - 14 AWG	3/8"	0.56"	0.40"	1.13"	0.85"	0.030"	0.070"	0.145"	100
94751	054007-94751	13-6S-P	12 - 10 AWG	6	0.28"	0.29"	0.98"	0.84"	0.040"	0.135"	0.250"	50
94753	054007-94753	13-8-P	12 - 10 AWG	8	0.38"	0.29"	1.03"	0.84"	0.040"	0.135"	0.250"	50
94741	054007-94741	13-10-P	12 - 10 AWG	10	0.38"	0.29"	1.03"	0.84"	0.040"	0.135"	0.250"	50
94743	054007-94743	13-14S-P	12 - 10 AWG	1/4"	0.53"	0.44"	1.26"	0.99"	0.040"	0.135"	0.250"	50
94749	054007-94749	13-56S-P	12 - 10 AWG	5/16"	0.53"	0.44"	1.26"	0.99"	0.040"	0.135"	0.250"	50
94745	054007-94745	13-38-P	12 - 10 AWG	3/8"	0.59"	0.44"	1.29"	0.99"	0.040"	0.135"	0.250"	50
94747	054007-94747	13-500-P	12 - 10 AWG	1/2"	0.75"	0.57"	1.50"	1.12"	0.040"	0.135"	0.250"	50

3M™ Specialty Bagged Terminals: 3M™ Ring Tongue

Nylon Insulated with Insulation Grip Ring Tongue, Bag

Terminal Type Ring
 Terminal Style Standard
 Insulation Material Nylon with Insulation Grip
 Barrel Style Butted
 RoHS 2011/65/EU Yes

Agency Approval  

Manufacturing Origin  **MADE IN USA**
 With U.S. and Global Content

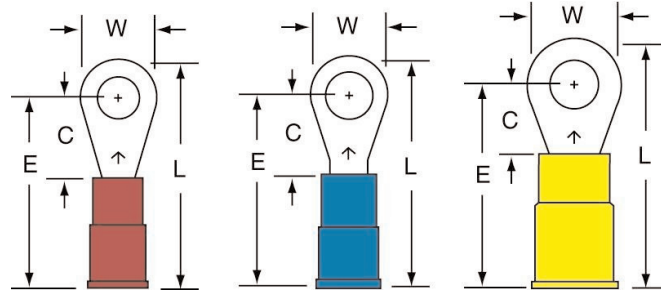

Product No.	UPC	Description	Conductor Size	Stud Size	(W)	(C)	(L)	(E)	Thickness	Barrel I.D.	Max. Insul. Dia.	Qty./Bag
94724	054007-94724	11-6S-NB	22 - 18 AWG	6	0.25"	0.22"	0.79"	0.66"	0.030"	0.070"	0.145"	100
94726	054007-94726	11-8-NB	22 - 18 AWG	8	0.33"	0.29"	0.89"	0.73"	0.030"	0.070"	0.145"	100
94716	054007-94716	11-10-NB	22 - 18 AWG	10	0.33"	0.29"	0.89"	0.73"	0.030"	0.070"	0.145"	100
94718	054007-94718	11-14S-NB	22 - 18 AWG	1/4"	0.47"	0.40"	1.07"	0.84"	0.030"	0.070"	0.145"	100
94722	054007-94722	11-56S-NB	22 - 18 AWG	5/16"	0.47"	0.40"	1.07"	0.84"	0.030"	0.070"	0.145"	100
94720	054007-94720	11-38-NB	22 - 18 AWG	3/8"	0.56"	0.40"	1.12"	0.84"	0.030"	0.070"	0.145"	100
94738	054007-94738	12-8-NB	16 - 14 AWG	8	0.33"	0.29"	0.91"	0.75"	0.030"	0.090"	0.170"	100
94728	054007-94728	12-10-NB	16 - 14 AWG	10	0.33"	0.29"	0.91"	0.75"	0.030"	0.090"	0.170"	100
94730	054007-94730	12-14S-NB	16 - 14 AWG	1/4"	0.47"	0.40"	1.09"	0.86"	0.030"	0.090"	0.170"	100
94734	054007-94734	12-56S-NB	16 - 14 AWG	5/16"	0.47"	0.40"	1.09"	0.86"	0.030"	0.090"	0.170"	100
94732	054007-94732	12-38-NB	16 - 14 AWG	3/8"	0.56"	0.40"	1.14"	0.86"	0.030"	0.090"	0.170"	100
94750	054007-94750	13-6S-NB	12 - 10 AWG	6	0.28"	0.29"	0.98"	0.84"	0.040"	0.135"	0.250"	50
94752	054007-94752	13-8-NB	12 - 10 AWG	8	0.38"	0.29"	1.03"	0.84"	0.040"	0.135"	0.250"	50
94740	054007-94740	13-10-NB	12 - 10 AWG	10	0.38"	0.29"	1.03"	0.84"	0.040"	0.135"	0.250"	50
94742	054007-94742	13-14S-NB	12 - 10 AWG	1/4"	0.53"	0.44"	1.26"	0.99"	0.040"	0.135"	0.250"	50
94748	054007-94748	13-56S-NB	12 - 10 AWG	5/16"	0.53"	0.44"	1.26"	0.99"	0.040"	0.135"	0.250"	50
94744	054007-94744	13-38-NB	12 - 10 AWG	3/8"	0.59"	0.44"	1.29"	0.99"	0.040"	0.135"	0.250"	50
94746	054007-94746	13-500-NB	12 - 10 AWG	1/2"	0.75"	0.57"	1.50"	1.12"	0.040"	0.135"	0.250"	50

Specialty Wire Terminals, Kits and Tools

3M™ Specialty Bagged Terminals: 3M™ Ring Tongues

Nylon Insulated Brazed Seam Ring Tongue, Bag

Terminal Type Ring
Terminal Style Standard
Insulation Material Nylon
Barrel Style Brazed
RoHS 2011/65/EU Yes
Agency Approval 
Manufacturing Origin 

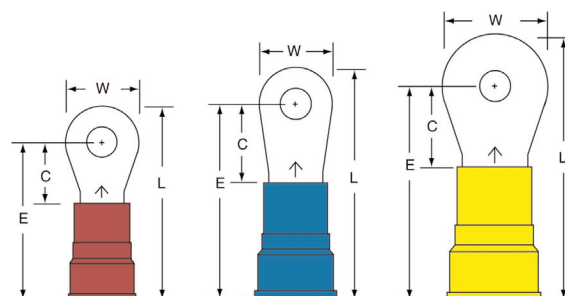

Product No.	UPC	Description	Conductor Size	Stud Size	(W)	(C)	(L)	(E)	Thickness	Barrel I.D.	Max. Insul. Dia.	Qty./Bag
94754	054007-94754	14-14S-WN	8 AWG	1/4"	0.47"	0.40"	1.26"	1.03"	0.050"	0.175"	0.340"	25
94757	054007-94757	14-56-WN	8 AWG	5/16"	0.59"	0.45"	1.38"	1.08"	0.050"	0.175"	0.340"	25
94755	054007-94755	14-38-WN	8 AWG	3/8"	0.59"	0.45"	1.38"	1.08"	0.050"	0.175"	0.340"	25
94756	054007-94756	14-500S-WN	8 AWG	1/2"	0.81"	0.69"	1.72"	1.32"	0.050"	0.175"	0.340"	25
94758	054007-94758	15-14S-WN	6 AWG	1/4"	0.47"	0.52"	1.50"	1.27"	0.050"	0.250"	0.440"	25
94761	054007-94761	15-56-WN	6 AWG	5/16"	0.63"	0.52"	1.58"	1.27"	0.050"	0.250"	0.440"	25
94759	054007-94759	15-38-WN	6 AWG	3/8"	0.63"	0.52"	1.58"	1.27"	0.050"	0.250"	0.440"	25
94760	054007-94760	15-500S-WN	6 AWG	1/2"	0.81"	0.63"	1.78"	1.38"	0.050"	0.250"	0.440"	25
94762	054007-94762	16-14-WN	4 AWG	1/4"	0.68"	0.53"	1.74"	1.41"	0.075"	0.280"	0.515"	10
94764	054007-94764	16-500S-WN	4 AWG	1/2"	0.68"	0.53"	1.74"	1.41"	0.075"	0.280"	0.515"	10

Specialty Wire Terminals, Kits and Tools

3M™ Specialty Bagged Terminals: 3M™ Ring Tongues

Heat Shrink Brazed Seam Ring Tongue, Bag

Terminal Type	Ring
Terminal Style	Standard
Insulation Material	Heat Shrink
Barrel Style	Brazed
RoHS 2011/65/EU	Yes
Manufacturing Origin	

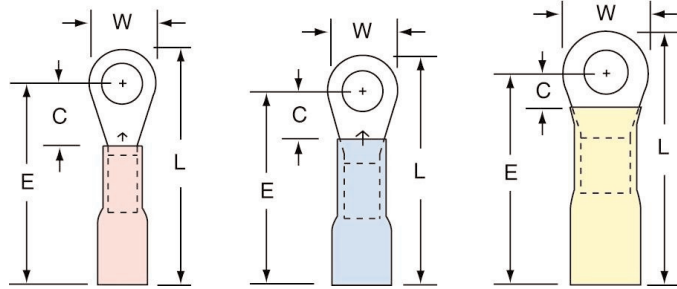



Product No.	UPC	Description	Conductor Size	Stud Size	(W)	(C)	(L)	(E)	Thickness	Barrel I.D.	Qty./Bag
94859	054007-94859	MH18-6R/L	22 - 18 AWG	6	0.31"	0.15"	1.00"	0.84"	0.030"	0.070"	25
94860	054007-94860	MH18-8R/L	22 - 18 AWG	8	0.31"	0.18"	1.00"	0.84"	0.030"	0.070"	25
94858	054007-94858	MH18-10R/L	22 - 18 AWG	10	0.31"	0.20"	1.00"	0.84"	0.030"	0.070"	25
94855	054007-94855	MH14-6R/L	16 - 14 AWG	6	0.31"	0.15"	1.00"	0.84"	0.030"	0.090"	25
94856	054007-94856	MH14-8R/L	16 - 14 AWG	8	0.31"	0.18"	1.00"	0.84"	0.030"	0.090"	25
94851	054007-94851	MH14-10R/L	16 - 14 AWG	10	0.31"	0.20"	1.00"	0.84"	0.030"	0.090"	25
94852	054007-94852	MH14-14R/S	16 - 14 AWG	1/4"	0.47"	0.26"	1.10"	0.86"	0.030"	0.090"	25
94853	054007-94853	MH14-38R	16 - 14 AWG	3/8"	0.56"	0.28"	1.10"	0.87"	0.030"	0.090"	25
94846	054007-94846	MH10-10R	12 - 10 AWG	10	0.38"	0.21"	1.10"	0.90"	0.040"	0.145"	25
94847	054007-94847	MH10-14R	12 - 10 AWG	1/4"	0.59"	0.29"	1.20"	0.90"	0.040"	0.145"	25
94848	054007-94848	MH10-38R	12 - 10 AWG	3/8"	0.59"	0.29"	1.20"	0.90"	0.040"	0.145"	25

Specialty Wire Terminals, Kits and Tools

3M™ Specialty Bagged Terminals: 3M™ Locking Forks

Vinyl Insulated Butted Seam Locking Fork, Bag

Terminal Type Fork
 Terminal Style Locking
 Insulation Material Vinyl
 Barrel Style Butted
 RoHS 2011/65/EU Yes

Agency Approval  

Manufacturing Origin 

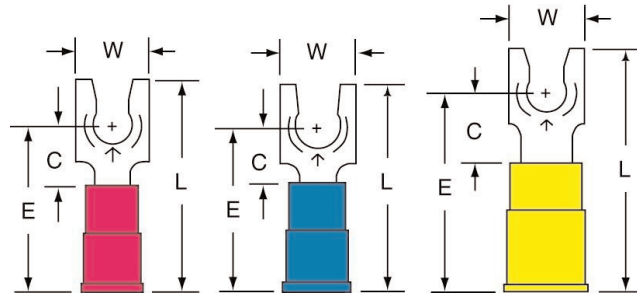

Product No.	UPC	Description	Conductor Size	Stud Size	Max. Lock Width	(W)	(C)	(L)	(E)	Thickness	Barrel I.D.	Max. Insul. Dia.	Qty./Bag
94865	054007-94865	SS-31-6-P	22 - 18 AWG	6	0.27"	0.25"	0.25"	0.88"	0.70"	0.030"	0.070"	0.145"	100
94867	054007-94867	SS-31-8-P	22 - 18 AWG	8	0.34"	0.30"	0.25"	0.88"	0.70"	0.030"	0.070"	0.145"	100
94863	054007-94863	SS-31-10-P	22 - 18 AWG	10	0.35"	0.32"	0.25"	0.88"	0.70"	0.030"	0.070"	0.145"	100
94873	054007-94873	SS-32-6-P	16 - 14 AWG	6	0.27"	0.25"	0.25"	0.88"	0.70"	0.030"	0.090"	0.170"	100
94875	054007-94875	SS-32-8-P	16 - 14 AWG	8	0.34"	0.30"	0.25"	0.88"	0.70"	0.030"	0.090"	0.170"	100
94869	054007-94869	SS-32-10-P	16 - 14 AWG	10	0.35"	0.32"	0.25"	0.88"	0.70"	0.030"	0.090"	0.170"	50
94871	054007-94871	SS-32-14-P	16 - 14 AWG	1/4"	0.48"	0.43"	0.40"	1.10"	0.85"	0.030"	0.090"	0.170"	100
94881	054007-94881	SS-33-6-P	12 - 10 AWG	6	0.30"	0.28"	0.28"	1.03"	0.83"	0.040"	0.135"	0.250"	50
94883	054007-94883	SS-33-8-P	12 - 10 AWG	8	0.35"	0.32"	0.28"	1.03"	0.83"	0.040"	0.135"	0.250"	50
94877	054007-94877	SS-33-10-P	12 - 10 AWG	10	0.36"	0.32"	0.28"	1.03"	0.83"	0.040"	0.135"	0.250"	50
94879	054007-94879	SS-33-14-P	12 - 10 AWG	1/4"	0.48"	0.43"	0.44"	1.24"	0.99"	0.040"	0.135"	0.250"	50

Specialty Wire Terminals, Kits and Tools

3M™ Specialty Bagged Terminals: 3M™ Locking Forks

Nylon Insulated with Insulation Grip Locking Fork, Bag

Terminal Type Fork
 Terminal Style Locking
 Insulation Material Nylon with Insulation Grip
 Barrel Style Butted
 RoHS 2011/65/EU Yes

Agency Approval



Manufacturing Origin

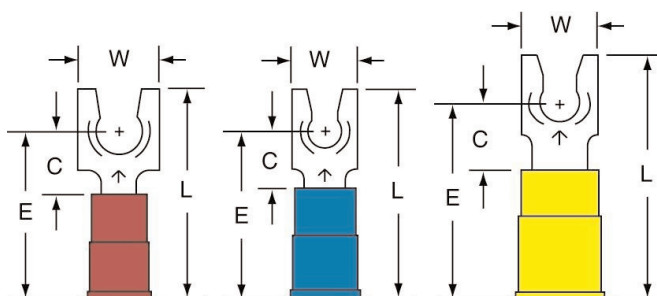



Product No.	UPC	Description	Conductor Size	Stud Size	Max. Lock Width	(W)	(C)	(L)	(E)	Thickness	Barrel I.D.	Max. Insul. Dia.	Qty./Bag
94864	054007-94864	SS-31-6-NB	22 - 18 AWG	6	0.27"	0.25"	0.25"	0.87"	0.69"	0.030"	0.070"	0.145"	100
94866	054007-94866	SS-31-8-NB	22 - 18 AWG	8	0.34"	0.30"	0.25"	0.87"	0.69"	0.030"	0.070"	0.145"	100
94862	054007-94862	SS-31-10-NB	22 - 18 AWG	10	0.35"	0.32"	0.25"	0.87"	0.69"	0.030"	0.070"	0.145"	100
94872	054007-94872	SS-32-6-NB	16 - 14 AWG	6	0.27"	0.24"	0.25"	0.89"	0.71"	0.030"	0.090"	0.170"	100
94874	054007-94874	SS-32-8-NB	16 - 14 AWG	8	0.34"	0.30"	0.25"	0.89"	0.71"	0.030"	0.090"	0.170"	100
94868	054007-94868	SS-32-10-NB	16 - 14 AWG	10	0.35"	0.32"	0.25"	0.89"	0.71"	0.030"	0.090"	0.170"	100
94870	054007-94870	SS-32-14-NB	16 - 14 AWG	1/4"	0.48"	0.43"	0.40"	1.11"	0.86"	0.030"	0.090"	0.170"	100
94880	054007-94880	SS-33-6-NB	12 - 10 AWG	6	0.30"	0.28"	0.28"	1.03"	0.83"	0.040"	0.135"	0.250"	50

Specialty Wire Terminals, Kits and Tools

3M™ Specialty Bagged Terminals: 3M™ Block Forks

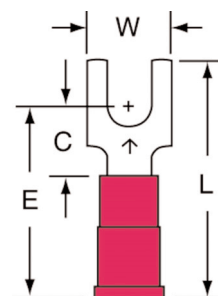

Vinyl Insulated Butted Seam Block Fork, Bag

Terminal Type Fork
Terminal Style Block
Insulation Material Vinyl
Barrel Style Butted
RoHS 2011/65/EU Yes
Agency Approval 
Manufacturing Origin 



Product No.	UPC	Description	Conductor Size	Stud Size	(W)	(C)	(L)	(E)	Thickness	Barrel I.D.	Max. Insul. Dia.	Qty./Bag
95351	054007-95351	BS-31-6-P	22 - 18 AWG	6	0.30"	0.25"	0.85"	0.70"	0.030"	0.070"	0.145"	100
95352	054007-95352	BS-31-8-P	22 - 18 AWG	8	0.30"	0.25"	0.85"	0.70"	0.030"	0.070"	0.145"	100
95350	054007-95350	BS-31-10-P	22 - 18 AWG	10	0.30"	0.25"	0.85"	0.70"	0.030"	0.070"	0.145"	100

Nylon Insulated with Insulation Grip Block Fork, Bag

Terminal Type Fork
Terminal Style Block
Insulation Material Nylon with Insulation Grip
Barrel Style Butted
RoHS 2011/65/EU Yes
Agency Approval 
Manufacturing Origin 

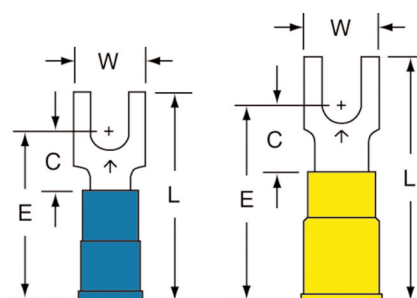



Product No.	UPC	Description	Conductor Size	Stud Size	(W)	(C)	(L)	(E)	Thickness	Barrel I.D.	Max. Insul. Dia.	Qty./Bag
95362	054007-95362	BS-32-10-NB	16 - 14 AWG	10	0.30"	0.25"	0.86"	0.71"	0.030"	0.090"	0.170"	100
95367	054007-95367	BS-33-8-NB	12 - 10 AWG	8	0.32"	0.29"	1.03"	0.84"	0.040"	0.135"	0.250"	50
95365	054007-95365	BS-33-10-NB	12 - 10 AWG	10	0.32"	0.29"	1.03"	0.84"	0.040"	0.135"	0.250"	50

Specialty Wire Terminals, Kits and Tools

3M™ Specialty Bagged Terminals: 3M™ Standard Forks

Vinyl Insulated Butted Seam Standard Fork, Bag

Terminal Type Fork
 Terminal Style Standard
 Insulation Material Vinyl
 Barrel Style Butted
 RoHS 2011/65/EU Yes
 Agency Approval 
 Manufacturing Origin 

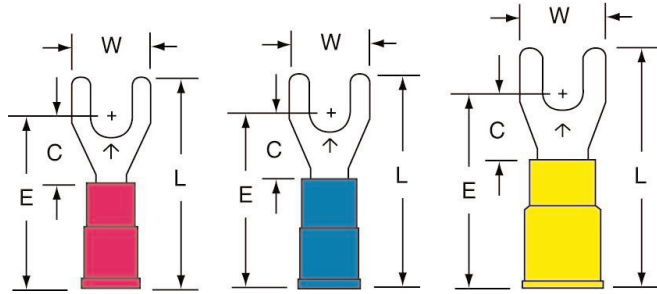

Product No.	UPC	Description	Conductor Size	Stud Size	(W)	(C)	(L)	(E)	Thickness	Barrel I.D.	Max. Insul. Dia.	Qty./Bag
94769	054007-94769	31-6-P	22 - 18 AWG	6	0.34"	0.29"	0.90"	0.74"	0.030"	0.070"	0.145"	100
94771	054007-94771	31-8-P	22 - 18 AWG	8	0.34"	0.29"	0.90"	0.74"	0.030"	0.070"	0.145"	100
94767	054007-94767	31-10-P	22 - 18 AWG	10	0.34"	0.29"	0.90"	0.74"	0.030"	0.070"	0.145"	100
94775	054007-94775	32-6-P	16 - 14 AWG	6	0.34"	0.29"	0.90"	0.74"	0.030"	0.090"	0.170"	100
94777	054007-94777	32-8-P	16 - 14 AWG	8	0.34"	0.29"	0.90"	0.74"	0.030"	0.090"	0.170"	100
94773	054007-94773	32-10-P	16 - 14 AWG	10	0.34"	0.29"	0.90"	0.74"	0.030"	0.090"	0.170"	100
94783	054007-94783	33-8-P	12 - 10 AWG	8	0.38"	0.29"	1.03"	0.84"	0.030"	0.135"	0.250"	100
94779	054007-94779	33-10-P	12 - 10 AWG	10	0.38"	0.29"	1.03"	0.84"	0.030"	0.135"	0.250"	100

Nylon Insulated with Insulation Grip Standard Fork, Bag

Terminal Type Fork
 Terminal Style Standard
 Insulation Material Nylon with Insulation Grip
 Barrel Style Butted
 RoHS 2011/65/EU Yes
 Agency Approval 
 Manufacturing Origin 

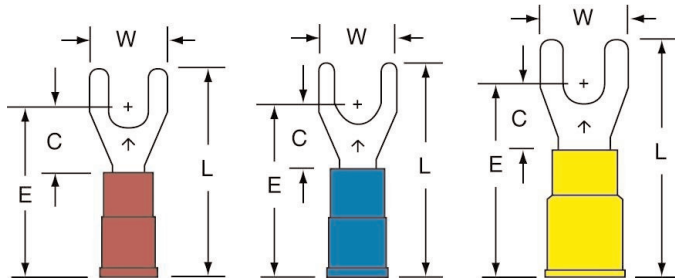

Product No.	UPC	Description	Conductor Size	Stud Size	(W)	(C)	(L)	(E)	Thickness	Barrel I.D.	Max. Insul. Dia.	Qty./Bag
94768	054007-94768	31-6-NB	22 - 18 AWG	6	0.34"	0.29"	0.89"	0.73"	0.030"	0.070"	0.145"	100
94770	054007-94770	31-8-NB	22 - 18 AWG	8	0.34"	0.29"	0.89"	0.73"	0.030"	0.070"	0.145"	100
94774	054007-94774	32-6-NB	16 - 14 AWG	6	0.34"	0.29"	0.91"	0.75"	0.030"	0.070"	0.145"	100
94776	054007-94776	32-8-NB	16 - 14 AWG	8	0.34"	0.29"	0.91"	0.75"	0.030"	0.070"	0.145"	100
94772	054007-94772	32-10-NB	16 - 14 AWG	10	0.34"	0.29"	0.91"	0.75"	0.030"	0.070"	0.145"	100
94780	054007-94780	33-6-NB	12 - 10 AWG	6	0.38"	0.29"	1.03"	0.84"	0.040"	0.135"	0.250"	50
94778	054007-94778	33-10-NB	12 - 10 AWG	10	0.38"	0.29"	1.03"	0.84"	0.040"	0.135"	0.250"	50

Specialty Wire Terminals, Kits and Tools

Kits and Tools

3M™ Scotchlok™ Terminal Kit STK-1 (Filled)

The 3M™ Scotchlok™ Terminal Kit is filled with 3M's most frequently purchased low voltage termination products, including 14 of our most popular terminals.

The STK-1 kit is constructed of durable metal with individual product compartments. While the compartments keep you organized, the rugged metal frame protects the contents even in harsh environments. This kit contains: 1 3M™ Scotchlok™ Crimping Tool TH-440; 1 3M™ ScotchCode™ Tape Dispenser STD-0-9; 100 3M™ Cable Ties 06225; 100 3M™ Cable Ties 06226; 50 3M™ Highland™ Ring Tongue Terminal RV18-6; 50 3M™ Highland™ Ring Tongue Terminal RV18-8; 50 3M™ Highland™ Ring Tongue Terminal RV14-6; 50 3M™ Highland™ Ring Tongue Terminal RV14-8; 50 3M™ Highland™ Ring Tongue Terminal RV14-10; 25 3M™ Highland™ Ring Tongue Terminal RV10-10; 50 3M™ Highland™ Block Fork Terminal BFV14-8; 50 3M™ Highland™ Block Fork Terminal BFV14-10; 50 3M™ Highland™ Block Fork Terminal BFV18-8; 50 3M™ Highland™ Block Fork Terminal BFV18-6; 50 3M™ Highland™ Butt Connector BSV18; 50 3M™ Highland™ Butt Connector BSV14; 25 3M™ Highland™ Butt Connector BSV10; 50 3M™ Highland™ Female Disconnect FDV14-250





Product No.	UPC	Description	Color
STK-1	051138-25348	Overall box size is 13-3/4" L x 10" W x 2-1/2" H.	Red

3M™ Scotchlok™ Terminal Boxes (Empty)

Manufacturing Origin



	RED-TERMINAL-BOX	CLEAR-TERMINAL-BOX
		
UPC	054007-11900	051128-57758
Description	This metal case with plastic insert tray is divided into 14 terminal compartments, one tool compartment and two miscellaneous compartments. Order contents separately.	This plastic organizing box for terminals is divided into 13 compartments, including one sized to hold a crimping tool. Order contents separately.
Color	Red	Clear

Specialty Wire Terminals, Kits and Tools

Kits and Tools

3M™ Scotchlok™ Terminal Kit SDKT Series (Filled)

The 3M™ Scotchlok™ SDKT-1 and 3M™ Scotchlok™ SDKT-2 Terminal Assortment Kits consists of a white plastic case with 12 individual product compartments, including a space for your 3M TH-440 crimping tool.



Product No.	UPC	Kit Contents (Part #)	Color	Boxes per Case
SDKT-1	054007-41983	(8) 71M-250-32-NL; (8) 72M-250-32-NL; (8) 73M-250-32-NL; (8) 801; (8) 952; (8) 722-N-A; (8) 71F-250-32-NL; (8) 72F-250-32-NL; (8) 73F-250-32-NL; (8) 801; (8) 952; (8) 718-N-A; (1) TH-440	White	20
SDKT-2	054007-41984	(12) 11-10-P; (12) 12-6S-P; (12) 12-10-P; (12) 13-10-P; (12) BS-31-6-P; (12) BS-32-6-P; (12) 32-10-P; (12) 72F-250-32-P; (11) 61-P; (10) 62-P; (13) 722-N-A; (8) 718-N-A; (1) TH-440.	White	20

3M™ Tools

	TH-440	TH-450	TR-482	TR-490
				
UPC	054007-30120	054007-49575	054007-11902	054007-70481
Product Name	3M™ Scissors, Style TH-440	3M™ Scissors, Style TH-450	3M™ Ratchet, Style TR-482	3M™ Ratchet, Style TR-490
Description	High carbon, heat-treated steel crimping tool that has a unique design that provides a high strength/weight ratio that crimps a broad range of 22-10 AWG terminals and connectors.	One of the most versatile heavy-duty tools 3M has offered. It is made of high-strength, heat-treated carbon steel.	This tool crimps the barrel and insulation grip simultaneously on 22-10 AWG insulated terminals and connectors. The 3M™ Ratchet Style TR-482 will crimp nylon or vinyl insulated, butted or brazed seam terminals and connectors.	This tool crimps the barrel and insulation grip independently on 22-10 AWG insulated and non-insulated terminals and connectors, nylon or vinyl insulated, butted or brazed seam.
Range	22-10 AWG	26-6 AWG	22-10 AWG	22-10 AWG
Manufacturing Origin	Taiwan	Taiwan		

Index by Product Number

Product Number	Page	Product Number	Page	Product Number	Page
07-10-250.....	46	12-10-P.....	15	12-6-P.....	14
07-6-250.....	46	12-10-W.....	13	12-6S.....	12
07-8-250.....	46	12-14-NB.....	16	12-6S-NB.....	16
10-10-WN.....	17	12-14-P.....	15	12-6S-P.....	14
10-2-WN.....	17	12-14S.....	12	12-6S-W.....	13
10-4-WN.....	17	12-14S-NB.....	16	12-6-W.....	13
10-6-WN.....	17	12-14S-P.....	15	12-8.....	12
10-8-WN.....	17	12-14S-W.....	13	12-8-NB.....	16
11-10.....	12	12-14-W.....	13	12-8-P.....	15
11-10-NB.....	16	12-26-NB.....	23	12-8S.....	12
11-10-P.....	14	12-26-P.....	22	12-8S-NB.....	16
11-10-W.....	13	123-10.....	19	12-8S-P.....	15
11-14S.....	12	123-10-NB.....	19	12-8S-W.....	13
11-14S-NB.....	16	123-14.....	19	12-8-W.....	13
11-14S-P.....	14	123-14-NB.....	19	13-10.....	12
11-14S-W.....	13	123-38.....	19	13-10-NB.....	16
11-26-NB.....	23	123-38-NB.....	19	13-10-P.....	15
11-2S-W.....	13	123-500-NB.....	19	13-10-W.....	13
11-38.....	12	123-56.....	19	13-14.....	12
11-38-NB.....	16	123-56-NB.....	19	13-14-NB.....	16
11-38-P.....	14	123-6S-NB.....	19	13-14-P.....	15
11-38-W.....	13	123-716-NB.....	19	13-14S.....	12
11-4S.....	12	12-38.....	12	13-14S-NB.....	16
11-4S-NB.....	15	123-8.....	19	13-14S-P.....	15
11-4S-P.....	14	12-38-NB.....	16	13-14S-W.....	13
11-4S-W.....	13	12-38-P.....	15	13-14-W.....	13
11-56S.....	12	123-8S-NB.....	19	13-38.....	12
11-56S-NB.....	16	12-38-W.....	13	13-38-NB.....	16
11-56S-P.....	14	12-4S.....	12	13-38-P.....	15
11-56S-W.....	13	12-4S-NB.....	16	13-38S-NB.....	16
11-610-NB.....	23	12-4S-P.....	14	13-38S-P.....	15
11-610-P.....	22	12-4S-W.....	13	13-38S-W.....	13
11-610-W.....	22	12-56.....	12	13-38-W.....	13
11-6S.....	12	12-56-NB.....	16	13-4S-NB.....	16
11-6S-NB.....	15	12-56-P.....	15	13-4S-P.....	15
11-6S-P.....	14	12-56S.....	12	13-500.....	12
11-6S-W.....	13	12-56S-NB.....	16	13-500-NB.....	16
11-8.....	12	12-56S-P.....	15	13-500-P.....	15
11-8-NB.....	15	12-56S-W.....	13	13-500-W.....	13
11-8-P.....	14	12-56-W.....	13	13-56.....	12
11-8S-NB.....	15	12-610.....	21	13-56-NB.....	16
11-8S-P.....	14	12-610-NB.....	23	13-56S.....	12
11-8-W.....	13	12-610-P.....	22	13-56S-NB.....	16
12-10.....	12	12-610-W.....	22	13-56S-P.....	15
12-10-NB.....	16	12-6-NB.....	16	13-56S-W.....	13

Index by Product Number

Index by Product Number

Index by Product Number

Product Number	Page	Product Number	Page	Product Number	Page
13-56-W	13	16-10-W	14	33-8-P	24
13-6	12	16-10-WN	17	33-8-W	24
13-610	21	16-14-W	14	41-10-NB	21
13-610-NB	23	16-14-WN	17	41-10-P	20
13-610-P	22	16-38-W	14	41-6-NB	21
13-610-W	22	16-38-WN	17	41-8	20
13-6-NB	16	16-500S-W	14	41-8-NB	21
13-6-P	15	16-500S-WN	17	41-8-P	20
13-6S	12	16-56-W	14	42-10	20
13-6S-NB	16	16-56-WN	17	42-10-NB	21
13-6S-P	15	16-716S-WN	17	42-10-P	20
13-6S-W	13	17-10-250	47	42-6-NB	21
13-6-W	13	17-6-250	47	42-6-P	20
13-716-NB	16	17-8-250	47	42-8	20
13-716-P	15	30-2-WN	25	42-8-NB	21
13-8	12	30-4-WN	25	42-8-P	20
13-8-NB	16	30-6-WN	25	43-10	20
13-8-P	15	31-10-NB	25	43-10-NB	21
13-8S-NB	16	31-10-P	24	43-10-P	20
13-8S-P	15	31-10-W	24	43-6-NB	21
13-8S-W	13	31-6-NB	25	43-8	20
13-8-W	13	31-6-P	24	43-8-NB	21
14-10S-W	13	31-6-W	24	43-8-P	20
14-10S-WN	17	31-8-NB	25	61	35
14-14S-W	14	31-8-P	24	61-NB	39
14-14S-WN	17	31-8-W	24	61-NBM-A	39
14-38-W	14	32-10	23	61-P	38
14-38-WN	17	32-10-NB	25	61-S	35
14-500S-W	14	32-10-P	24	61-SN	36
14-500S-WN	17	32-10-W	24	61-SN-A	36
14-500-W	14	32-6-NB	25	61-SP	37
14-56-W	14	32-6-P	24	62	35
14-56-WN	17	32-6-W	24	62-NB	39
14-716S-W	14	32-8-NB	25	62-NBM-A	39
15-10S-W	14	32-8-P	24	62-P	38
15-10S-WN	17	32-8-W	24	62-S	35
15-14S-W	14	33-10	23	62-SN	36
15-14S-WN	17	33-10-NB	25	62-SN-A	36
15-38-W	14	33-10-P	24	62-SP	37
15-38-WN	17	33-10-W	24	63	35
15-500S-W	14	33-6-NB	25	63-NB	39
15-500S-WN	17	33-6-P	24	63-NBM-A	39
15-56-W	14	33-6-W	24	63-P	38
15-56-WN	17	33-8	23	63-S	35
15-58-W	14	33-8-NB	25	63-SN	36

Index by Product Number

Product Number	Page	Product Number	Page	Product Number	Page
63-SN-A.....	36	72F-250-32-P.....	42	82F-180-NBL-A.....	44
63-SP.....	37	72M-187-20.....	45	82M-156-A.....	46
64-W.....	36	72M-187-20-NB.....	49	82M-156-NB-A.....	50
64-WP.....	38	72M-187-20-NBL.....	49	82M-156-P-A.....	48
65-W.....	36	72M-187-20-NL.....	48	82M-180-A.....	46
65-WP.....	38	72M-187-20-P.....	47	82M-180-NB-A.....	50
66-W.....	36	72M-250-32.....	45	82M-180-P-A.....	48
66-WP.....	38	72M-250-32-NB.....	49	82P-47-NB-A.....	56
70F-110-20-PB.....	41	72M-250-32-NBL.....	49	82P-47-P-A.....	56
70F-110-32-PB.....	41	72M-250-32-NL.....	48	83P-55-NB-A.....	56
718-N-A.....	57	72M-250-32-P.....	47	83P-55-P-A.....	56
71F-110-20-NB-A.....	44	73F-250-32.....	40	91.....	57
71F-187-20.....	40	73F-250-32-NB.....	44	91-P.....	58
71F-187-20-NB.....	44	73F-250-32-NBL.....	43	92-P.....	58
71F-187-20-NBL.....	43	73F-250-32-NL.....	42	93.....	57
71F-187-20-NL.....	42	73F-250-32-P.....	42	93-P.....	58
71F-187-20-P.....	42	73F-375-50.....	40	94716.....	76
71F-250-32.....	40	73F-375-50-NB.....	44	94717.....	74
71F-250-32-NB.....	44	73F-375-50-P.....	42	94718.....	76
71F-250-32-NBL.....	43	73M-250-32.....	45	94719.....	74
71F-250-32-NL.....	42	73M-250-32-NB.....	49	94720.....	76
71F-250-32-P.....	42	73M-250-32-NBL.....	49	94722.....	76
71M-187-20.....	45	73M-250-32-NL.....	48	94724.....	76
71M-187-20-NB.....	49	73M-250-32-P.....	47	94725.....	74
71M-187-20-NBL.....	49	751-187.....	41	94726.....	76
71M-187-20-NL.....	48	751-250.....	41	94727.....	74
71M-187-20-P.....	47	752-187.....	41	94728.....	76
71M-250-32.....	45	752-250.....	41	94729.....	74
71M-250-32-NB.....	49	771-250-NB-A.....	51	94730.....	76
71M-250-32-NBL.....	49	771-250-P-A.....	51	94731.....	75
71M-250-32-NL.....	48	772-250-A.....	50	94732.....	76
71M-250-32-P.....	47	772-250-NB-A.....	51	94733.....	75
722-N-A.....	57	772-250-P-A.....	51	94734.....	76
72F-110-20-A.....	40	77-250-A.....	52	94735.....	75
72F-110-20-NB-A.....	44	7M-250.....	52	94736.....	74
72F-110-20-P-A.....	42	7MMF-250.....	52	94738.....	76
72F-187-20.....	40	81F-156-NBL-A.....	44	94739.....	74
72F-187-20-NB.....	44	81F-180-NBL-A.....	44	94740.....	76
72F-187-20-NBL.....	43	81M-156-NB-A.....	50	94741.....	75
72F-187-20-NL.....	42	81M-156-P-A.....	48	94742.....	76
72F-187-20-P.....	42	81M-180-NB-A.....	50	94743.....	75
72F-250-32.....	40	81M-180-P-A.....	48	94744.....	76
72F-250-32-NB.....	44	81P-47-NB-A.....	56	94745.....	75
72F-250-32-NBL.....	43	81P-47-P-A.....	56	94746.....	76
72F-250-32-NL.....	42	82F-156-NBL-A.....	44	94747.....	75

Index by Product Number

Index by Product Number

Product Number	Page	Product Number	Page	Product Number	Page
94748	76	94799	71	94844-A	73
94749	75	94800	69	94845-A	73
94750	76	94801	69	94846	78
94751	75	94802	70	94847	78
94752	76	94803	71	94848	78
94753	75	94804	69	94850	68
94754	77	94805	72	94851	78
94755	77	94806	73	94852	78
94756	77	94807	74	94853	78
94757	77	94808	72	94855	78
94758	77	94809	72	94856	78
94759	77	94810	73	94857	68
94760	77	94811	74	94858	78
94761	77	94812	72	94859	78
94762	77	94813-A	66	94860	78
94764	77	94814	69	94861	68
94767	82	94815	70	94862	80
94768	82	94816	71	94863	79
94769	82	94817	69	94864	80
94770	82	94818	69	94865	79
94771	82	94819	70	94866	80
94772	82	94820	71	94867	79
94773	82	94821	69	94868	80
94774	82	94822	72	94869	79
94775	82	94823	73	94870	80
94776	82	94824	74	94871	79
94777	82	94825	72	94872	80
94778	82	94826	72	94873	79
94779	82	94827	73	94874	80
94780	82	94828	74	94875	79
94783	82	94829	72	94877	79
94784	67	94830	69	94879	79
94785	66	94831	70	94880	80
94786-A	68	94832	71	94881	79
94787	67	94833	69	94883	79
94788	66	94834	72	95350	81
94789-A	68	94835	73	95351	81
94790	67	94836	74	95352	81
94791	66	94837	72	95362	81
94792-A	68	94838-A	70	95365	81
94793	67	94839-A	70	95367	81
94795	67	94840-A	73	BFV10-10Q	61
94796-A	66	94841-A	73	BFV10-6Q	61
94797	69	94842-A	70	BFV10-8Q	61
94798	70	94843-A	71	BFV14-10Q	61

Index by Product Number

Index by Product Number

Product Number	Page	Product Number	Page	Product Number	Page
BFV14-6Q	61	BS-31-6S-NB	28	FDI18-250Q	63
BFV14-8Q	61	BS-31-6S-P	27	FDV10-250Q	63
BFV18-10Q	61	BS-31-6S-W	26	FDV14-187Q	63
BFV18-6Q	61	BS-31-6-W	26	FDV14-250Q	63
BFV18-8Q	61	BS-31-8	26	FDV18-187Q	63
BS-21-10-NB	30	BS-31-8-NB	28	FDV18-250Q	63
BS-21-10-P	30	BS-31-8-P	27	FV10-10Q	61
BS-21-10-W	29	BS-31-8-W	26	FV10-8Q	61
BS-21-6	29	BS-32-10	26	FV14-10Q	61
BS-21-6-NB	30	BS-32-10-NB	28	FV14-6Q	61
BS-21-6-P	30	BS-32-10-P	27	FV14-8Q	61
BS-21-6S-NB	30	BS-32-10-W	26	HT-11-10	53
BS-21-6S-P	30	BS-32-4S-NB	28	HT-11-14	53
BS-21-8	29	BS-32-4S-P	27	HT-11-6S	53
BS-21-8-NB	30	BS-32-6	26	HT-12-10	53
BS-21-8-P	30	BS-32-6-NB	28	HT-12-14	53
BS-22-10	29	BS-32-6-P	27	HT-12-6S	53
BS-22-10-NB	31	BS-32-6S	26	HT-13-10	53
BS-22-10-P	30	BS-32-6S-NB	28	HT-13-14	53
BS-22-6	29	BS-32-6S-P	27	HT-13-38	53
BS-22-6-NB	30	BS-32-6S-W	26	HT-13-6	53
BS-22-6-P	30	BS-32-6-W	26	HT-14-14S	53
BS-22-6S-NB	30	BS-32-8	26	HT-15-38	53
BS-22-6S-P	30	BS-32-8-NB	28	HT-16-38	53
BS-22-8-NB	31	BS-32-8-P	27	HT-31-10	53
BS-22-8-P	30	BS-32-8-W	26	HT-32-10	53
BS-23-10	29	BS-33-10	26	HT-33-10	53
BS-23-10-NB	31	BS-33-10-NB	28	HT-61	54
BS-23-10-P	30	BS-33-10-P	27	HT-62	54
BS-23-10-W	29	BS-33-10-W	27	HT-63	54
BS-23-6-NB	31	BS-33-6-NB	28	HT-72F-187-20	55
BS-23-6-P	30	BS-33-6-P	27	HT-72F-250-32	55
BS-23-8-NB	31	BS-33-6-W	26	HT-72M-187-20	55
BS-23-8-P	30	BS-33-8	26	HT-72M-250-32	55
BS-31-10	26	BS-33-8-NB	28	HT-73F-250-32-A	55
BS-31-10-NB	28	BS-33-8-P	27	HT-752-250-32	56
BS-31-10-P	27	BS-33-8-W	27	HT-BS-31-6	54
BS-31-10-W	26	BSV10Q	62	HT-BS-32-6	54
BS-31-4S	26	BSV14Q	62	L-11-10	12
BS-31-4S-NB	28	BSV18Q	62	L-11-10-NB	16
BS-31-4S-P	27	CLEAR-TERMINAL-BOX	83	L-11-10-P	14
BS-31-6	26	FDI10-250Q	63	L-11-10-W	13
BS-31-6-NB	28	FDI14-187Q	63	L-11-6-NB	15
BS-31-6-P	27	FDI14-250Q	63	L-11-6-P	14
BS-31-6S	26	FDI18-187Q	63	L-11-6-W	13

Index by Product Number

Index by Product Number

Index by Product Number

Product Number	Page	Product Number	Page	Product Number	Page
L-11-8-NB.....	15	MH14-10R/LX.....	18	RV10-38Q.....	60
L-11-8-P.....	14	MH14-14FLK.....	34	RV10-516Q.....	60
L-11-8-W.....	13	MH14-14FLX.....	34	RV10-6Q.....	60
L-12-10.....	12	MH14-14R/SK.....	18	RV10-8Q.....	60
L-12-10-NB.....	16	MH14-14R/SX.....	18	RV14-10Q.....	60
L-12-10-P.....	15	MH14-38RK.....	18	RV14-14Q.....	60
L-12-10-W.....	13	MH14-38RX.....	18	RV14-516Q.....	60
L-12-6-NB.....	16	MH14-516R/SK.....	18	RV14-6Q.....	60
L-12-6-P.....	14	MH14-516R/SX.....	18	RV14-8Q.....	60
L-12-6-W.....	13	MH14-6FLK.....	34	RV18-10Q.....	60
L-12-8-NB.....	16	MH14-6FLX.....	34	RV18-14Q.....	60
L-12-8-P.....	15	MH14-6R/LK.....	18	RV18-6Q.....	60
L-12-8-W.....	13	MH14-6R/LX.....	18	RV18-8Q.....	60
LFV10-10Q.....	62	MH14-8FLK.....	34	SDTK-1.....	84
LFV10-6Q.....	62	MH14-8FLX.....	34	SDTK-2.....	84
LFV10-8Q.....	62	MH14-8R/LK.....	18	SS-31-10.....	31
LFV14-10Q.....	62	MH14-8R/LX.....	18	SS-31-10-NB.....	33
LFV14-6Q.....	62	MH18-10FLK.....	34	SS-31-10-P.....	32
LFV14-8Q.....	62	MH18-10FLX.....	34	SS-31-4.....	31
LFV18-6Q.....	62	MH18-10R/LK.....	18	SS-31-4-NB.....	33
LFV18-8Q.....	62	MH18-10R/LX.....	18	SS-31-6.....	31
MC1/OBC.....	37	MH18-6FLK.....	34	SS-31-6-NB.....	33
MC1BC.....	37	MH18-6FLX.....	34	SS-31-6-P.....	32
MC2/OBC.....	37	MH18-6R/LK.....	18	SS-31-8.....	31
MC250BC.....	37	MH18-6R/LX.....	18	SS-31-8-NB.....	33
MC2BC.....	37	MH18-8FLK.....	34	SS-31-8-P.....	32
MC3/OBC.....	37	MH18-8FLX.....	34	SS-32-10.....	31
MC4/OBC.....	37	MH18-8R/LK.....	18	SS-32-10-NB.....	33
MH10-10FLK.....	34	MH18-8R/LX.....	18	SS-32-10-P.....	32
MH10-10FLX.....	34	MNHU10-250DFI.....	45	SS-32-14.....	31
MH10-10RK.....	18	MNHU14-250DFI.....	45	SS-32-14-NB.....	33
MH10-10RX.....	18	MNHU18-250DFI.....	45	SS-32-14-P.....	32
MH10-14FLK.....	34	MTI10-250Q.....	64	SS-32-4-NB.....	33
MH10-14FLX.....	34	MTI14-187Q.....	64	SS-32-4-P.....	32
MH10-14RK.....	18	MTI14-250Q.....	64	SS-32-6.....	31
MH10-14RX.....	18	MTI18-187Q.....	64	SS-32-6-NB.....	33
MH10-38RK.....	18	MTI18-250Q.....	64	SS-32-6-P.....	32
MH10-38RX.....	18	MTV10-250Q.....	64	SS-32-8.....	31
MH10-8FLK.....	34	MTV14-187Q.....	64	SS-32-8-NB.....	33
MH10-8FLX.....	34	MTV14-250Q.....	64	SS-32-8-P.....	32
MH10-8RK.....	18	MTV18-187Q.....	64	SS-33-10.....	31
MH10-8RX.....	18	MTV18-250Q.....	64	SS-33-10-NB.....	33
MH14-10FLK.....	34	RED-TERMINAL-BOX.....	83	SS-33-10-P.....	32
MH14-10FLX.....	34	RV10-10Q.....	60	SS-33-14.....	31
MH14-10R/LK.....	18	RV10-14Q.....	60	SS-33-14-NB.....	33

Index by Product Number

Product Number	Page
SS-33-14-P.....	32
SS-33-6.....	31
SS-33-6-NB.....	33
SS-33-6-P.....	32
SS-33-8.....	31
SS-33-8-NB.....	33
SS-33-8-P.....	32
STK-1.....	83
TH-440.....	84
TH-450.....	84
TR-482.....	84
TR-490.....	84

Index by Product Number

3M, Scotchlok, Highland and Scotchcode are trademarks of 3M Company.

The images, pictures, and illustrations found in this catalog are for illustration purposes only. Check the Product Technical Data Sheets for actual product details.

3M products listed in this publication that are associated with a U.S.A. flag are manufactured in the USA as of the date of publication. 3M products offered on a government contract that require country of origin representation must be certified by 3M's Trade Compliance Department (contact your customer service support team to request a certification).

"RoHS 2011/65/EU" means that the product or part does not contain any of the substances in excess of the maximum concentration values ("MCVs") in EU RoHS Directive 2011/65/EU. The MCVs are by weight in homogeneous materials. This information represents 3M's knowledge and belief, which may be based in whole or in part on information provided by third party suppliers to 3M.

Important Notice

Before using this product, you must evaluate it and determine if it is suitable for your intended application. You assume all risks and liability associated with such use.

Warranty; Limited Remedy; Limited Liability.

3M's product warranty is stated in its Product Literature available upon request. **3M MAKES NO OTHER WARRANTIES INCLUDING, BUT NOT LIMITED TO, ANY IMPLIED WARRANTY OF MERCHANTABILITY OR FITNESS FOR A PARTICULAR PURPOSE.** If this product is defective within the warranty period stated above, your exclusive remedy shall be, at 3M's option, to replace or repair the 3M product or refund the purchase price of the 3M product. **Except where prohibited by law, 3M will not be liable for any indirect, special, incidental or consequential loss or damage arising from this 3M product, regardless of the legal theory asserted.**

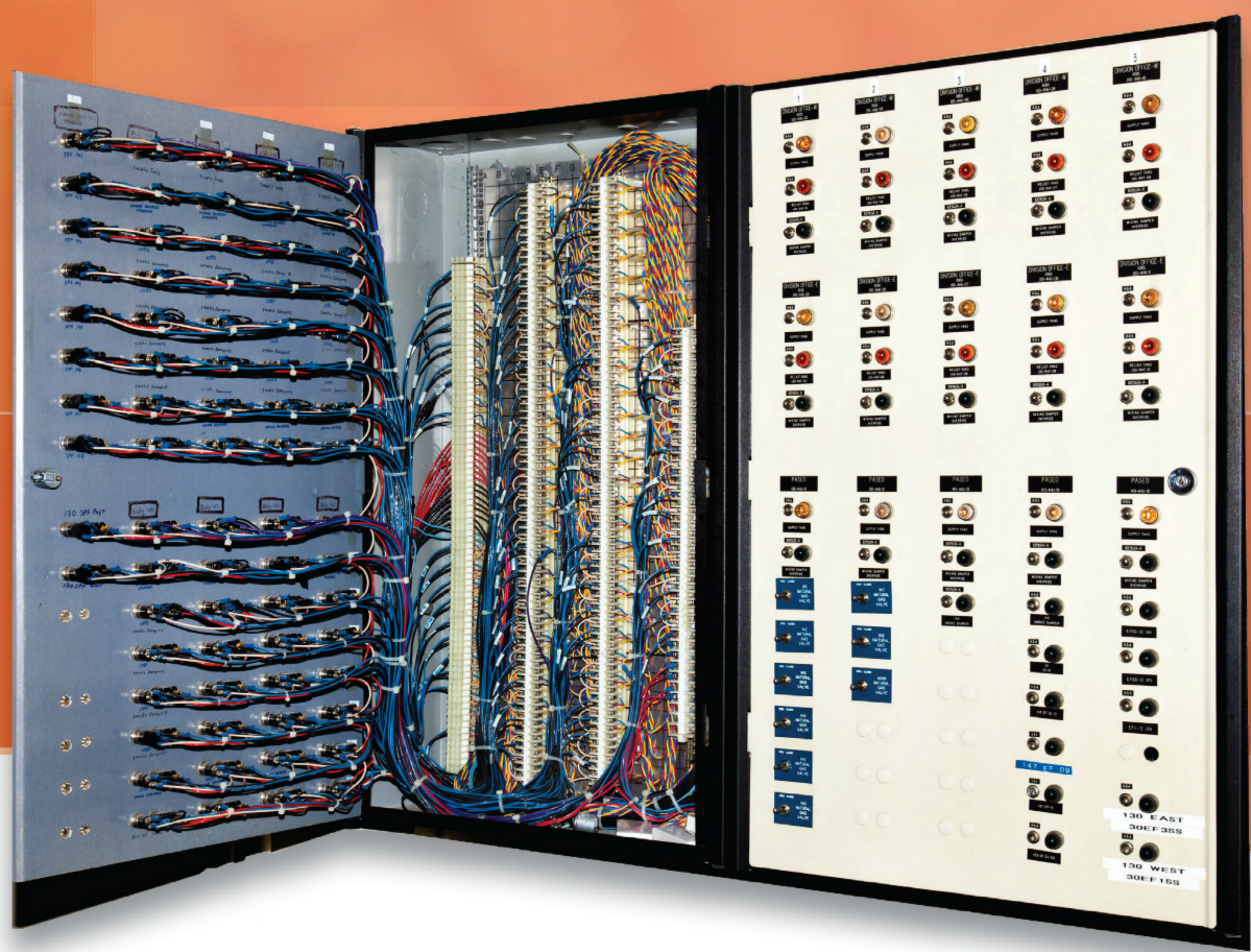

Electrical Markets Division

6801 River Place Blvd.
Austin, TX 78726-9000
800/245 3573
Fax 800/245 0329
www.3M.com/electrical

Please recycle. Printed in USA.
© 3M 2014. All rights reserved.
80-6016-0705-6

Looking for pricing, stock, or lifecycle information?

Click below to explore more details on WIN SOURCE:

 [View 07-8-250 on WIN SOURCE](#)

 [3M Information](#)

Optimize Your Supply Chain with WIN SOURCE Solutions

-  Global Sourcing Solution
-  Obsolete Management
-  Cost Control Management
-  Shortage Management
-  Alternative Solution
-  Excess Inventory Management