



**THE DATASHEET OF
ACML-0603H-121-T**



High Current Multilayer Ferrite Chip Bead



ACML-0603H-xxx Series

Request Samples



Check Inventory



1.6 x 0.8 x 0.8 mm
RoHS/RoHS II Compliant
MSL Level = 1

Features

- Multilayer monolithic structure yields high reliability
- Unique terminal electrode structure ensures permissible currents
- High impedance over a wide frequency range

Applications

- Audio & Video Equipment
- Automotive Electrical Equipment
- Communication Equipment
- OA Equipment

Electrical Specifications

Part Number	Z(Ω) $\pm 25\%$	Z Test Freq.(MHz)	Rdc (Ω) Max.	Ir (mA) Max.
ACML-0603H-100	10	100	0.020	3000
ACML-0603H-300	30	100	0.030	3000
ACML-0603H-600	60	100	0.040	2500
ACML-0603H-121	120	100	0.050	2000
ACML-0603H-221	220	100	0.100	1400
ACML-0603H-331	330	100	0.140	1200
ACML-0603H-391	390	100	0.140	1000
ACML-0603H-471	470	100	0.200	1000
ACML-0603H-601	600	100	0.350	500

Test Conditions and Equipment

Ir: Rated current applied when the chip surface temperature rise just 40°C against chip surface temperature. Electric power supplier, Electric current meter, Thermometer.

Z: Impedance Analyzer HP4291 or equivalent, 50mV.

DCR: LCR Meter HP4263A or equivalent

Operating Temperature

-55°C to +125°C

Storage Temperature

-55°C to +125°C and RH 70% (Max)



5101 Hidden Creek Ln Spicewood TX 78669
Phone: 512-371-6159 | Fax: 512-351-8858
For terms and conditions of sales, please visit:
www.abracon.com

REVISED: 07-29-20

ABRACON IS
ISO9001-2015
CERTIFIED

High Current Multilayer Ferrite Chip Bead



ACML-0603H-xxx Series

Request Samples

Check Inventory

1.6 x 0.8 x 0.8 mm
 RoHS/RoHS II Compliant
 MSL Level = 1

Part Identification

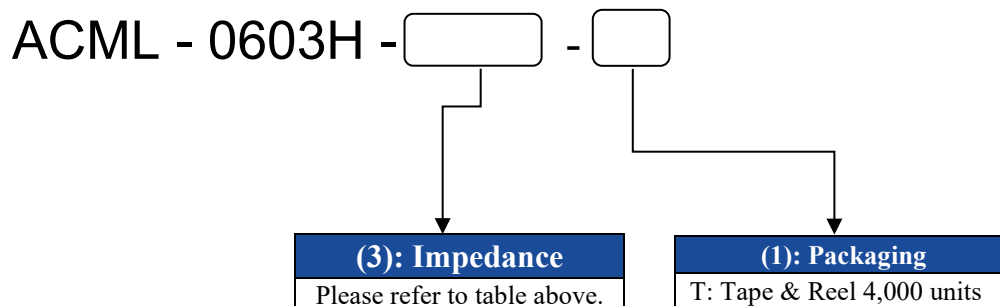

Mechanical Specifications

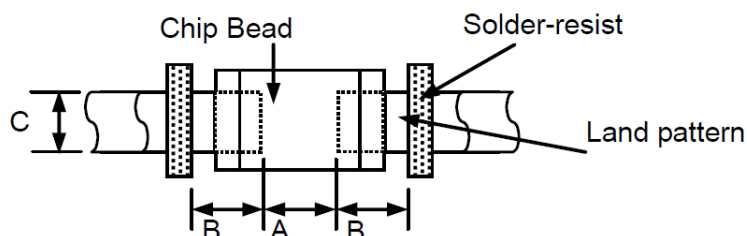
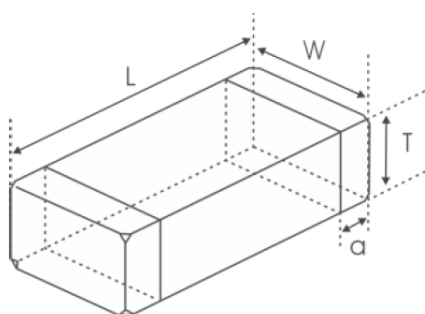

Recommended Layout Pattern

L	W	T	a	A	B	C
1.6±0.15	0.8±0.15	0.8±0.15	0.3±0.2	0.60 ~ 0.80	0.60 ~ 0.80	0.60 ~ 0.80

Dimensions: mm

High Current Multilayer Ferrite Chip Bead



ACML-0603H-xxx Series

Request Samples



Check Inventory



1.6 x 0.8 x 0.8 mm
 RoHS/RoHS II Compliant
 MSL Level = 1

Materials

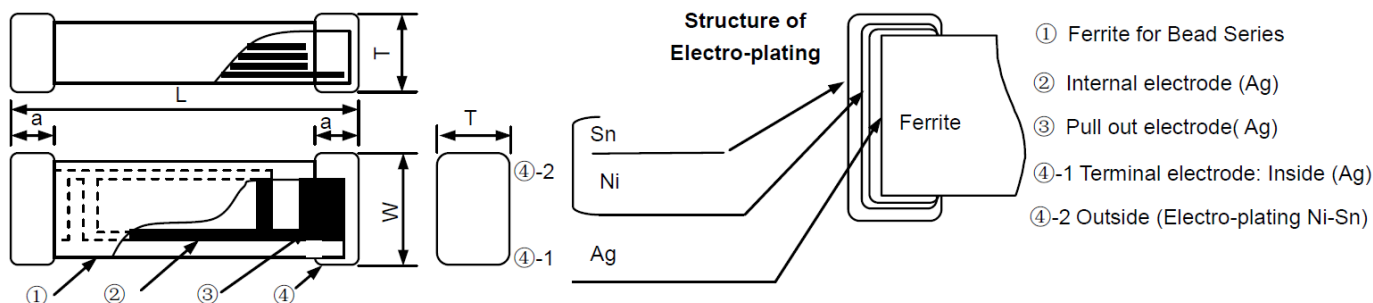

Section	Part Name	Material Name
①	Ferrite Body	Ferrite Powder
②	Inner Coils	Silver Paste
③	Pull-out Electrode (Ag)	Silver Paste
④-1	Terminal Electrode: Inside Ag	Termination Silver Composition
④-2	Electro-Plating: Ni/Sn plating	Plating Chemicals

High Current Multilayer Ferrite Chip Bead



ACML-0603H-xxx Series

Request Samples

Check Inventory

1.6 x 0.8 x 0.8 mm
 RoHS/RoHS II Compliant
 MSL Level = 1

Reflow Profile

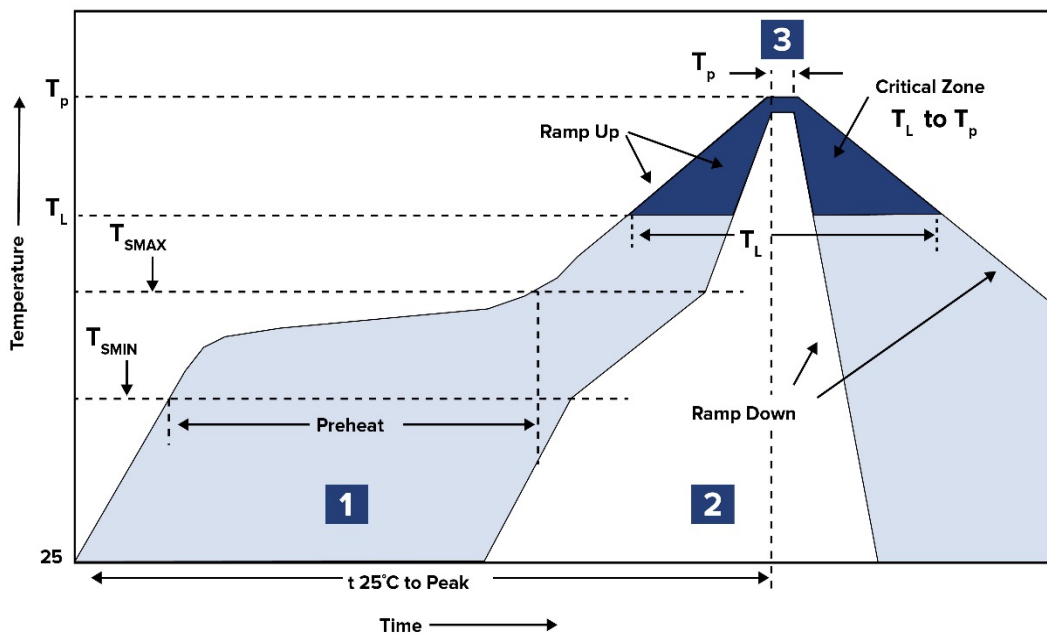

Zone	Description	Temperature	Times
1	Preheat	$T_{SMIN} \sim T_{SMAX}$ 150°C ~ 180°C	60 ~ 120 sec.
2	Reflow	T_L 180°C -230°C	60 ~ 90 sec.
3	Peak heat	T_P 260°C±5°C	10 sec. MAX

High Current Multilayer Ferrite Chip Bead



ACML-0603H-xxx Series

Request Samples

Check Inventory

1.6 x 0.8 x 0.8 mm
 RoHS/RoHS II Compliant
 MSL Level = 1

Packaging

T=Tape and reel (4,000 pcs/reel)

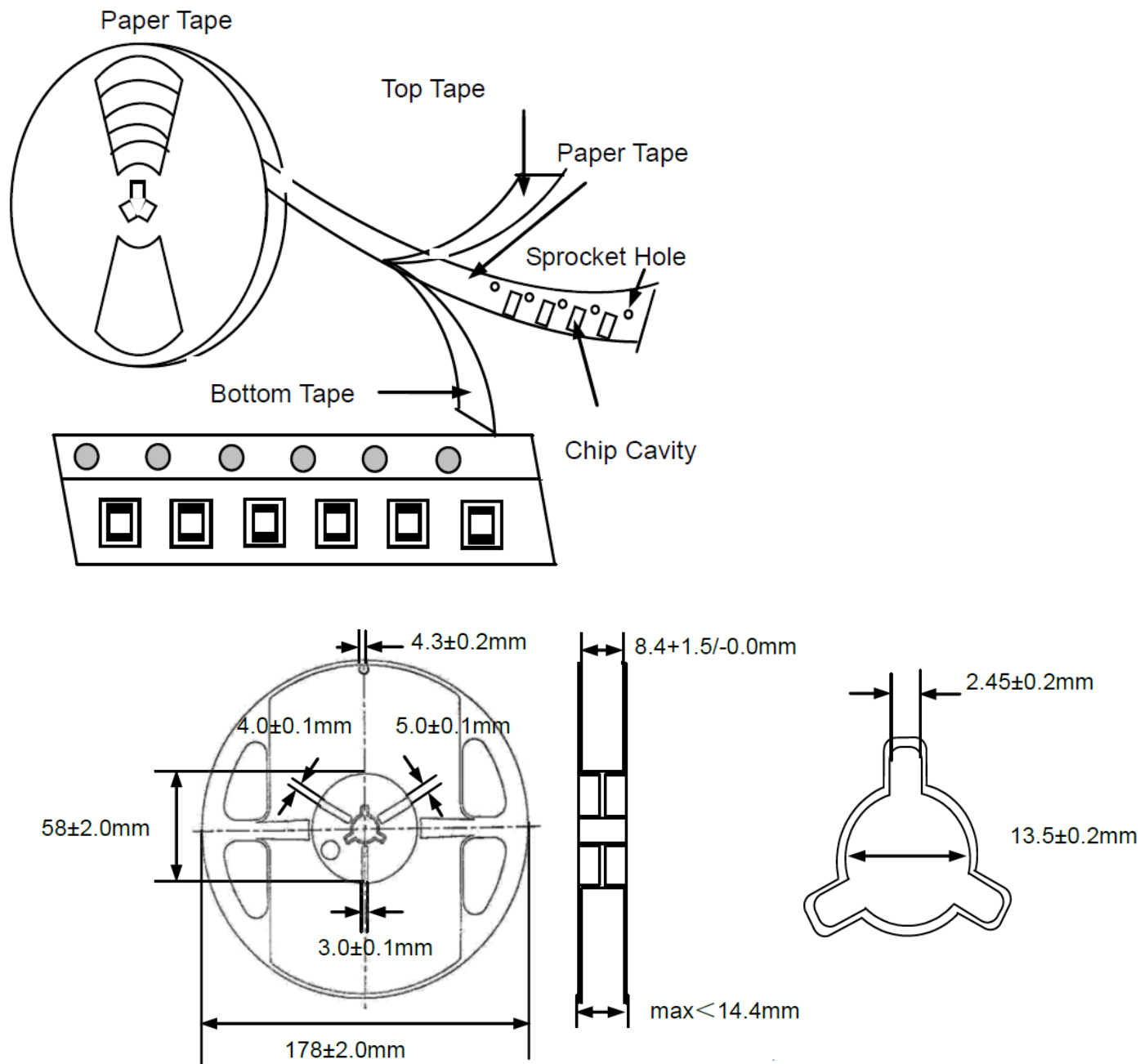

5101 Hidden Creek Ln Spicewood TX 78669
 Phone: 512-371-6159 | Fax: 512-351-8858
 For terms and conditions of sales, please visit:
www.abracon.com

REVISED: 07-29-20

ABRACON IS
 ISO9001-2015
 CERTIFIED

High Current Multilayer Ferrite Chip Bead



ACML-0603H-xxx Series

Request Samples

Check Inventory

1.6 x 0.8 x 0.8 mm
RoHS/RoHS II Compliant
MSL Level = 1

Packaging

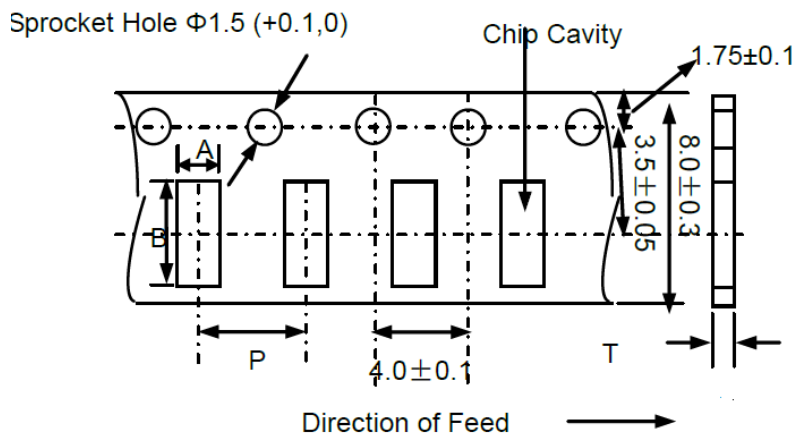

A	B	P	Tmax	H
1.0±0.2	1.8±0.2	4.0±0.1	1.1	10

Dimensions: mm

ATTENTION: Abracon LLC's products are COTS – Commercial-Off-The-Shelf products; suitable for Commercial, Industrial and, where designated, Automotive Applications. Abracon's products are not specifically designed for Military, Aviation, Aerospace, Life-dependent Medical applications or any application requiring high reliability where component failure could result in loss of life and/or property. For applications requiring high reliability and/or presenting an extreme operating environment, written consent and authorization from Abracon LLC is required. Please contact Abracon LLC for more information.





5101 Hidden Creek Ln Spicewood TX 78669
Phone: 512-371-6159 | Fax: 512-351-8858
For terms and conditions of sales, please visit:
www.abracon.com

REVISED: 07-29-20

ABRACON IS
ISO9001-2015
CERTIFIED

Looking for pricing, stock, or lifecycle information?

Click below to explore more details on WIN SOURCE:

-  [View ACML-0603H-121-T on WIN SOURCE](#)
-  [Abracon LLC Information](#)

Optimize Your Supply Chain with WIN SOURCE Solutions

-  Global Sourcing Solution
-  Obsolete Management
-  Cost Control Management
-  Shortage Management
-  Alternative Solution
-  Excess Inventory Management