



THE DATASHEET OF CMD264-UBD



CMD264-UBD

3mm (T-1) LED Through Hole

Blue LED Lamp



Superior optical performance.

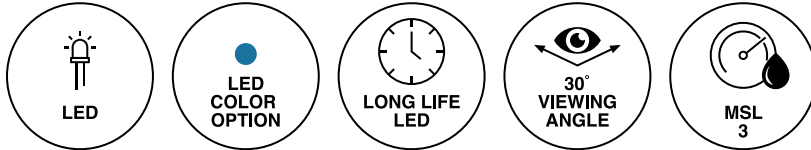

Application

- Commercial Outdoor Signs
- Device Lights
- Front Panel Indicators
- Front Panel Backlighting
- Navigation Systems
- Backlit Keypads
- IoT
- Industrial Control Systems
- Storage Servers

Key Features

- LED bulb size: 3mm (T-1)
- Precision optical performance InGaN blue LED
- Blue diffused lens color
- Smooth and spatial radiation patterns
- Consistent color
- Ideal in bright sunlight conditions (operating temperature limit of +185°F (85°C))
- Through-hole technology
- Superior resistance to moisture
- Moisture Sensitive Level (MSL): 3
- Viewing Angle: 30
- RoHS and REACH compliance

Ordering Data

Series	Description
CMD264-UBD	3mm (T-1) Blue LED Through Hole

Product Dimensions

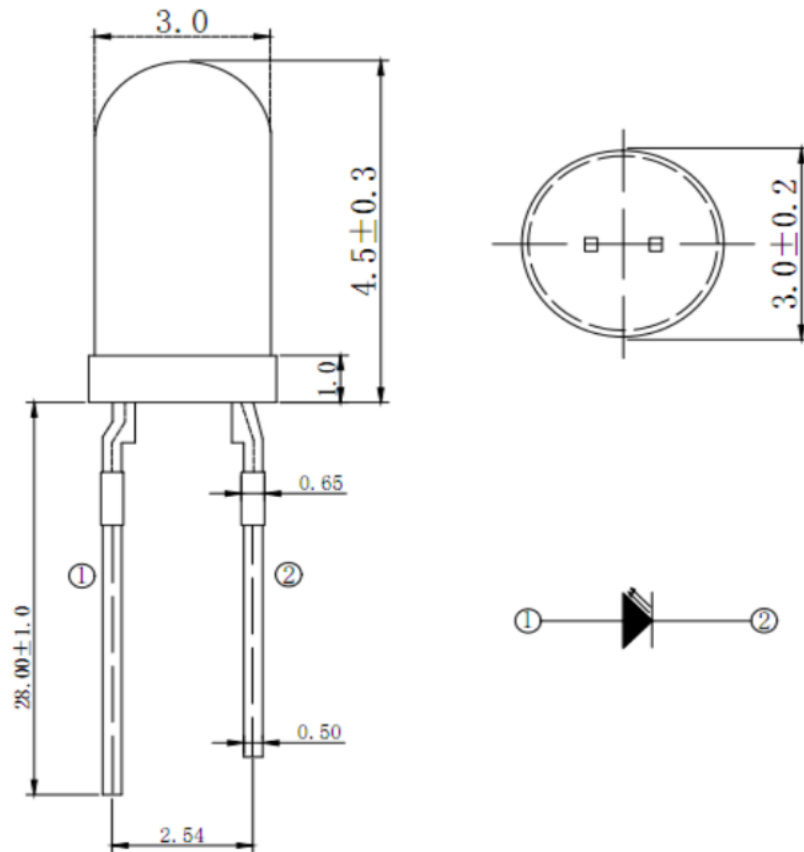

Notes:

1. All dimensions are in millimeters [inches]
2. Tolerance is ± 0.25 [0.01] unless otherwise noted.
3. The specifications, characteristics and technical data described in the datasheet are subject to change without prior notice.

Product Specifications

Absolute Maximum Ratings at Ta= 25°C

Parameter	Symbol	Rating	Unit
Forward Current	IF	30	mA
Operating Temperature	Topr	-40 ~ +85	°C
Storage Temperature	Tstg	-40 ~ +100	°C
Soldering Temperature (Reflow Soldering)	Tsol	250 (for 5 sec)	°C
Power Dissipation	Pd	130	mW
Peak Forward Current (Duty 1/10 @ 1KHZ)	IFP	100	mA
Reverse Voltage	VR	5	V
Electrostatic Discharge	ESD	1000	V

Electrical-Optical Characteristics

Parameter	Symbol	Min	Typ.	Max.	Unit	Condition
Peak Wavelength	λ_p	--	460	--	nm	IF=20mA
Dominant Wavelength	λ_d	--	466	--	nm	IF=20mA
Luminous Intensity	Iv	15	--	30	mcd	IF=20mA
Viewing Angle	2 θ 1/2	--	30	--	deg	IF=20mA
Forward Voltage	VF	2.8	--	4.5	V	IF=20mA
Spectrum Radiation Bandwidth	$\Delta\lambda$	--	35	--	nm	IF=20mA
Reverse Current	IR	--	--	10	μ A	VR=5V

Product Specifications

Typical Electrical-Optical Characteristics Curves

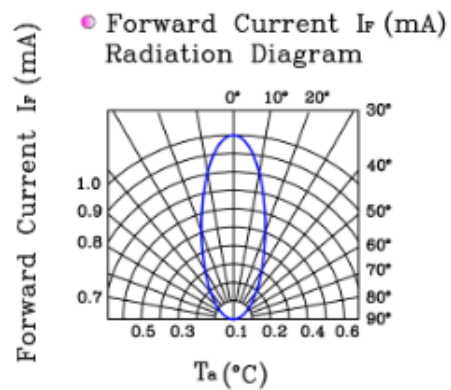
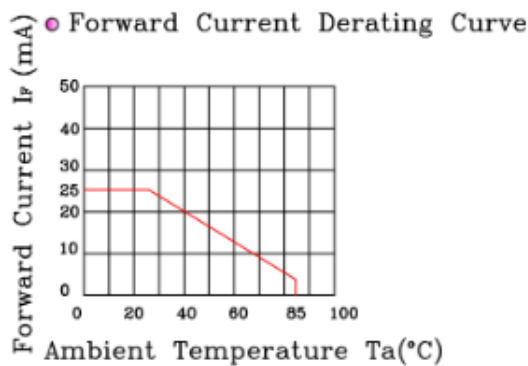
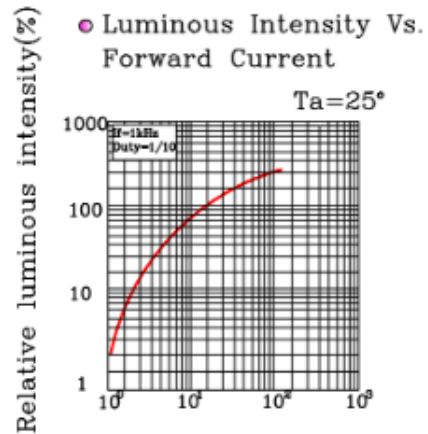
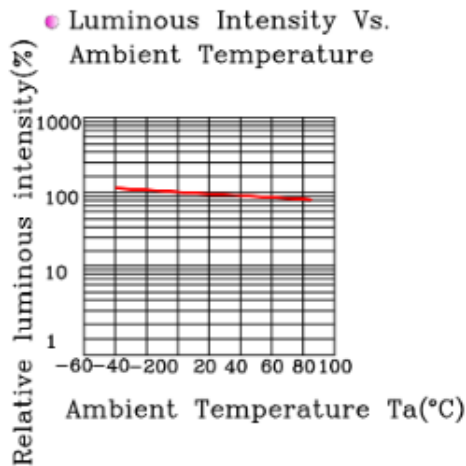
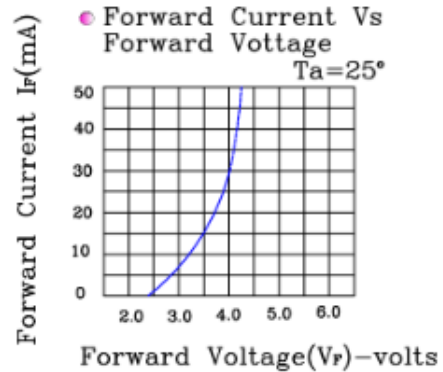
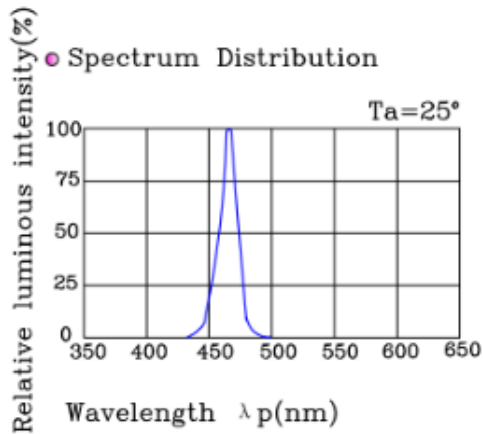

Reliability Data

Reliability Test Conditions

No.	Items	Test Condition	Test Hours/Cycles	Sample Size	Ac/Re
1	Reflow Soldering	Temp. : 255°C±5°C Min. 5 sec.	6 Min.	22 PCS	0/1
2	Temperature Cycle	H : +100°C 15min ↓ 5 min L : -40°C 15min	100 Cycles	22 PCS.	0/1
3	Thermal Shock	H : +100°C 5min ↓ 10 sec L : -10°C 5min	100 Cycles	22 PCS.	0/1
4	High Temperature Storage	Temp. : 100°C	1000 Hrs.	22 PCS.	0/1
5	Low Temperature Storage	Temp. : -40°C	1000 Hrs.	22 PCS.	0/1
6	DC Operating Life	IF = 20 mA / 25°C	1000 Hrs.	22 PCS.	0/1
7	High Temperature / High Humidity	85°C/85%RH	1000 Hrs.	22 PCS.	0/1

Recommended Reflow Soldering Profile

Soldering Condition (Recommended wave soldering profile)

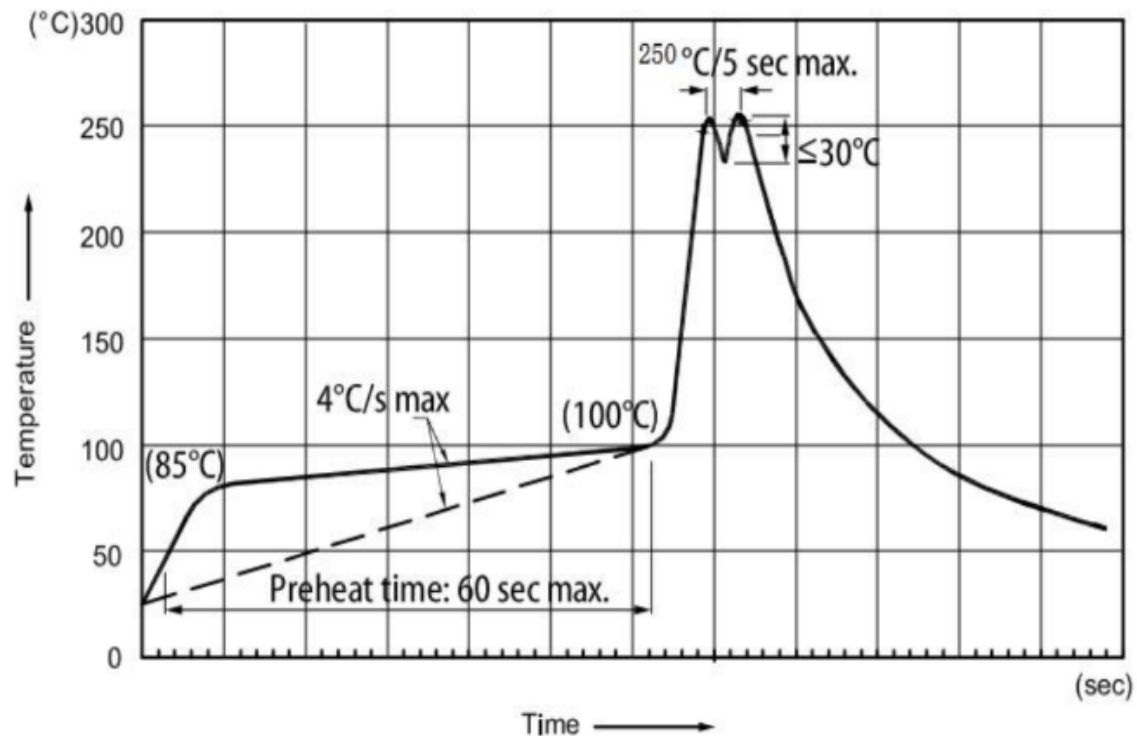

- Pb-free solder temperature profile.
- Reflow soldering should not be done more than one times.
- When soldering, do not put stress on the LED's during heating.
- After soldering, do not warp the circuit board.

Soldering Iron

Each terminal is to go to the tip of soldering iron temperature less than 350°C for 3 seconds within once in less than the soldering iron capacity 25W. Leave two seconds and more intervals, and do soldering of each terminal. Be careful because the damage of the product is often started at the time of the hand solder.

Precautions

Storage

- Do not open moisture proof bag before the product are ready to use.
- Before opening the package: The LED's should be kept 30°C or less and 90%RH or less.
- After opening the package: The LED's floor life is 1 year under 30 deg C or less and 60% RH or less.
If unused LED's remain, it should be stored in moisture proof packages.
- If the moisture absorbent material (silica gel) has faded away or the LED's have exceeded the storage time, baking treatment should be performed using the following conditions.

Circuit Design Notes

Lead Forming

- During lead formation, the leads should be bent at a point at least 3mm from the base of the epoxy bulb.
- Lead forming should be done before soldering.
- Avoid stressing the LED package during leads forming. The stress to the base may damage the LED's characteristics or it may break the LEDs.
- Cut the LED lead frames at room temperature. Cutting the lead frames at high temperatures may cause failure of the LEDs.
- LEDs are mounted wit stress at the leads, it causes deterioration of the epoxy resin and this will degrade the LEDs.

Cleaning

- When necessary, cleaning should occur only with isopropyl alcohol at room temperature for a duration of no more than one minute. Dry at room temperature before use.
- Do not clean the LEDs by the ultrasonic. When it is absolutely necessary, the influence of ultrasonic cleaning on the LEDs depends on factors such as ultrasonic power and the assembled condition. Ultrasonic cleaning shall be pre-qualified to ensure this will not cause damage to the LED.

Heat Management

- Heat management of LEDs must be taken into consideration during the design stage of LED application. The current should be de-rated appropriately by referring to the de-rating curve found in each product specification.
- The temperature surrounding the LED in the application should be controlled. Please refer to the data sheet de-rating curve.

ESD

- The products are sensitive to static electricity or surge voltage. ESD can damage a die and its reliability. When handling the products, the following measures against electrostatic discharge are strongly recommended.
 - Eliminating the charge
 - Grounded wrist strap, ESD footwear, clothes, and floors.
 - Grounded workstation equipment and tools
 - ESD table/shelf mat made of conductive materials
- Proper grounding is required for all devices, equipment, and machinery used in product assembly. Surge protection should be considered when designing of commercial products.
- If tools or equipment contain insulating materials such as glass or plastic, the following measures against electrostatic discharge are strongly recommended:
 - Dissipating static charge with conductive materials
 - Preventing charge generation with moisture
 - Neutralizing the charge with ionizers

Circuit Design Notes

Directions for Use

- The LEDs should be operated with forward bias. The driving circuit must be designed so that the LEDs are not subjected to forward or reverse voltage while it is off. If reverse voltage is continuously applied to the LEDs, it may cause migration resulting in LED damage.

Compliances and Approvals



Looking for pricing, stock, or lifecycle information?

Click below to explore more details on WIN SOURCE:

- ⊖ [View CMD264-UBD on WIN SOURCE](#)
- ⊖ [Visual Communications Company - VCC Information](#)

Optimize Your Supply Chain with WIN SOURCE Solutions

- ✓ Global Sourcing Solution
- ✓ Obsolete Management
- ✓ Cost Control Management
- ✓ Shortage Management
- ✓ Alternative Solution
- ✓ Excess Inventory Management