



**THE DATASHEET OF
TL59FF260Q**



SERIES TL59/TL58 SWITCHES

TACT SWITCHES RADIAL LEAD

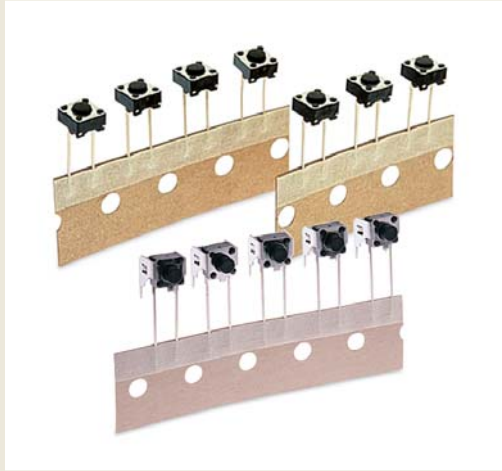

FEATURES & BENEFITS

- ▶ Designed for automatic feed
- ▶ Radial lead packaging

APPLICATIONS/MARKETS

- ▶ Telecommunications
- ▶ Consumer Electronics
- ▶ Audio/visual
- ▶ Medical
- ▶ Testing/instrumentation
- ▶ Computer/servers/peripherals

SPECIFICATIONS

Contact Rating:	50mA @ 12 VDC
Life Expectancy:	100,000 cycles
Contact Resistance:	100mΩ max., typical @ 2-4 VDC 100mA for both silver plated contacts
Insulation Resistance:	100MΩ min.
Dielectric Strength:	250 VAC
Actuation Force:	100 ± 50 gf, 160 ± 50 gf, 260 ± 50 gf
Operating Temperature:	-20°C to 70°C
Travel:	0.25 Typ

MATERIALS

Housing:	Polybutylene Terephthalate (PBT) or 6/6 Nylon
Actuator:	Polybutylene Terephthalate (PBT) or 6/6 Nylon
Bracket/Cover:	Tin plated steel
Contacts:	Silver plated phosphor bronze
Terminals:	Silver plated brass

HOW TO ORDER

SERIES	MODEL NO.	ACTUATOR ("L" Dimension)	OPERATING FORCE	CONTACT MATERIAL
TL	59	N = 4.3mm A = 5.0mm B = 9.5mm C = 8.0mm F = 7.0mm E = 7.3mm P = 8.5mm	F100 F160 F260	Q = Silver
TL	58 Right Angle	V = 3.85mm W = 3.15mm X = 4.75mm	F100 F160 F260	Q = Silver

▶ ▶ ▶ Example Ordering Number
TL-59-N-F160-Q

Specifications subject to change without notice.

TACT SWITCHES

NAVIGATION SWITCHES

PUSHBUTTON SWITCHES

TOGGLE SWITCHES

ROCKER SWITCHES

SLIDE SWITCHES

SNAP-ACTION SWITCHES

DIP SWITCHES

KEYLOCK SWITCHES

ROTARY SWITCHES

DETECTOR SWITCHES

CAP OPTIONS



TL 59

STANDARD RADIAL LEAD

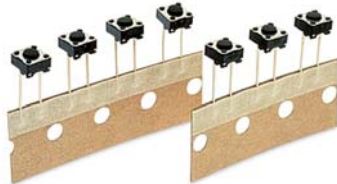

Actuator Length (L) in mm		
N = 4.3	C = 8.0	P = 8.5
A = 5.0	F = 7.0	
B = 9.5	E = 7.3	

Operating Force	
F100	= 100 ± 50gf
F160	= 160 ± 50gf
F260	= 260 ± 50gf

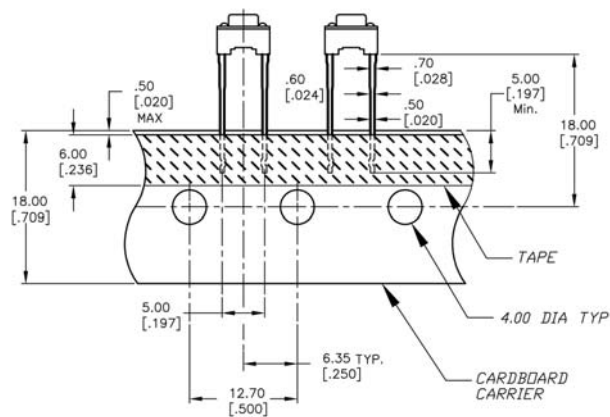
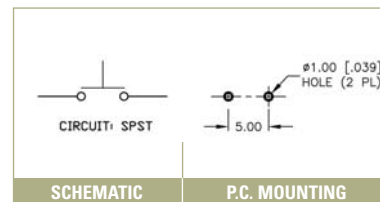
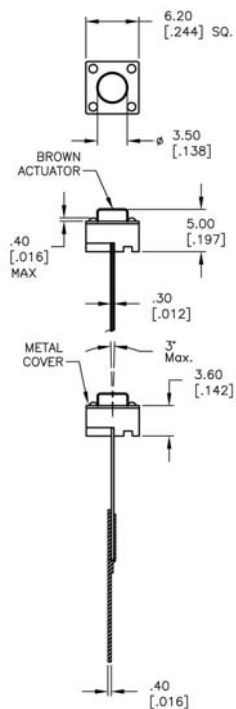

TL 58

RIGHT ANGLE RADIAL LEAD

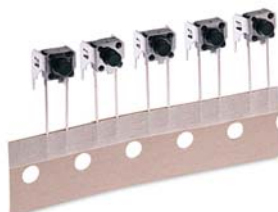

Actuator Length (L) in mm	
V	= 3.85
W	= 3.15
X	= 4.75

Operating Force	
F100	= 100 ± 50gf
F160	= 160 ± 50gf
F260	= 260 ± 50gf

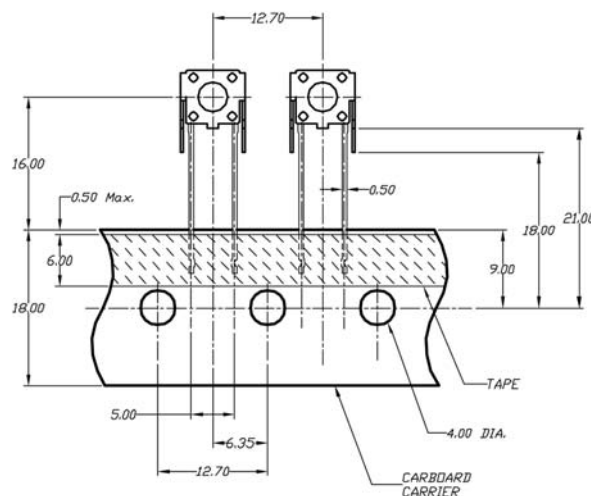
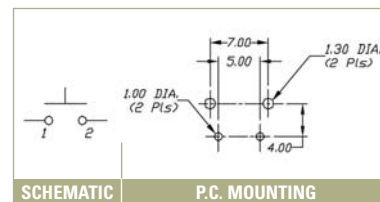
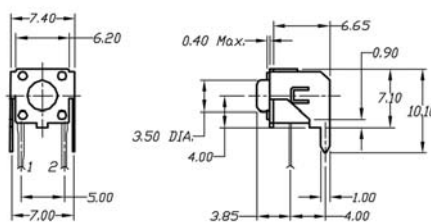

TACT SWITCHES

NAVIGATION SWITCHES

PUSHBUTTON SWITCHES

TOGGLE SWITCHES

ROCKER SWITCHES

SLIDE SWITCHES

SNAP-ACTION SWITCHES

DIP SWITCHES

KEYLOCK SWITCHES

ROTARY SWITCHES

DETECTOR SWITCHES

CAP OPTIONS

Looking for pricing, stock, or lifecycle information?

Click below to explore more details on WIN SOURCE:

 [View TL59FF260Q on WIN SOURCE](#)

 [E-SWITCH](#) Information

Optimize Your Supply Chain with WIN SOURCE Solutions

-  Global Sourcing Solution
-  Obsolete Management
-  Cost Control Management
-  Shortage Management
-  Alternative Solution
-  Excess Inventory Management