



**THE DATASHEET OF
RDE5C3A101J2M1H03A**



Reference Specification

Leaded MLCC for Consumer Electronics & Industrial Equipment
RDE Series

Product specifications in this catalog are as of Apr. 2025, and are subject to change or obsolescence without notice.
Please consult the approval sheet before ordering. Please read rating and Cautions first.

<Reference> Please kindly use our website.

Please refer to the product information page for more information on ceramic capacitors. → [Ceramic capacitor product information](#)

Various data can be obtained directly from the product search. → [Product search \(SMD\)](#) / [Product search \(Lead Type\)](#)

[CONTENTS]

- **Scope**
- **Rating**
- **Marking**
- **Part number list**
- **Specification**
- **Packing specification**
- **Taping specification**
- ** CAUTION & NOTICE & NOTE**

1. Scope

This product specification is applied to Leaded MLCC RDE series.

1. Specific applications:

- Consumer Equipment: Products that can be used in consumer equipment such as home appliances, audio/visual equipment, communication equipment, information equipment, office equipment, and household robotics, and whose functions are not directly related to the protection of human life and property.
- Industrial Equipment: Products that can be used in industrial equipment such as base stations, manufacturing equipment, industrial robotics equipment, and measurement equipment, and whose functions do not directly relate to the protection of human life and property.
- Medial Equipment [GHTF A/B/C] except for Implant Equipment: Products suitable for use in medical devices designated under the GHTF international classifications as Class A or Class B (the functions of which are not directly involved in protection of human life or property) or in medical devices other than implants designated under the GHTF international classifications as Class C (the malfunctioning of which is considered to pose a comparatively high risk to the human body).
- Automotive infotainment/comfort equipment: Products that can be used for automotive equipment such as car navigation systems and car audio systems that do not directly relate to human life and whose structure, equipment, and performance are not specifically required by law to meet technical standards for safety assurance or environmental protection.

2. Unsuitable Application: Applications listed in "Limitation of applications" in this product specification.

WE DISCLAIM ANY LOSS AND DAMAGES ARISING FROM OR IN CONNECTION WITH THE PRODUCTS INCLUDING BUT NOT LIMITED TO THE CASE SUCH LOSS AND DAMAGES CAUSED BY THE UNEXPECTED ACCIDENT, IN EVENT THAT THE PRODUCT IS APPLIED FOR THE PURPOSE WHICH IS SPECIFIED ABOVE AS THE UNSUITABLE APPLICATION FOR THE PRODUCT.

2. Rating

• Part Number Configuration

ex.)

<u>RDE</u>	<u>5C</u>	<u>2E</u>	<u>223</u>	<u>J</u>	<u>2</u>	<u>K1</u>	<u>H03</u>	<u>B</u>
Series	Temperature Characteristics	Rated Voltage	Capacitance	Capacitance Tolerance	Dimension (LxW)	Lead Style	Individual Specification	Package

• Temperature Characteristics

Code	Temp. Char.	Temp. Range	Temp.coef.	Standard Temp.	Operating Temp. Range
5C	C0G (EIA code)	-55~25°C	0+30/-72ppm/°C	25°C	-55~125°C
		25~125°C	0+/-30ppm/°C		

• Rated Voltage

Code	Rated voltage
2E	DC250V
2J	DC630V
3A	DC1000V

• Capacitance

The first two digits denote significant figures ; the last digit denotes the multiplier of 10 in pF.

ex.) In case of 223 .

$$22 \times 10^3 = 22000 \text{ pF}$$

Reference only

• Capacitance Tolerance

Code	Capacitance Tolerance
J	+/-5%

• Dimension (LxW)

Please refer to [Part number list].

• Lead Style

*Lead wire is "solder coated CP wire".

Code	Lead Style	Lead spacing (mm)
K1	Inside crimp type	5.0+/-0.8
M1	Inside crimp taping type	5.0+0.6/-0.2

• Individual Specification

Murata's control code.

Please refer to [Part number list].



• Package

Code	Package
A	Taping type of Ammo
B	Bulk type

3. Marking

- Temp. char. : Letter code : A (C0G Char.)
 Capacitance : Actual numbers (Less than 100pF)
 3 digit numbers (100pF and over)
 Capacitance tolerance : Code
 Rated voltage : Letter code : 4 (DC250V. Except dimension code : 1)
 Letter code : 7 (DC630V. Except dimension code : 1)
 Letter code : A (DC1000V.)
 Company name code : Abbreviation :  (Except dimension code : 1)

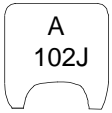
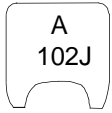
(Ex.)

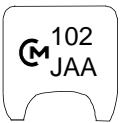
Rated voltage \ Dimension code	DC250V	DC630V	DC1000V
1			-
2			

4. Part number list

- Inside Crimp
(Lead Style:K*)

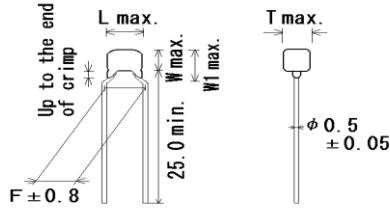

Unit : mm

Customer Part Number	Murata Part Number	T.C.	DC Rated Volt. (V)	Cap.	Cap. Tol.	Dimension (mm)					Dimension (LxW) Lead Style	Pack qty. (pcs)
						L	W	W1	F	T		
	RDE5C2E100J1K1H03B	C0G	250	10pF	±5%	4.5	3.5	5.0	5.0	3.15	1K1	500
	RDE5C2E120J1K1H03B	C0G	250	12pF	±5%	4.5	3.5	5.0	5.0	3.15	1K1	500
	RDE5C2E150J1K1H03B	C0G	250	15pF	±5%	4.5	3.5	5.0	5.0	3.15	1K1	500
	RDE5C2E180J1K1H03B	C0G	250	18pF	±5%	4.5	3.5	5.0	5.0	3.15	1K1	500
	RDE5C2E220J1K1H03B	C0G	250	22pF	±5%	4.5	3.5	5.0	5.0	3.15	1K1	500
	RDE5C2E270J1K1H03B	C0G	250	27pF	±5%	4.5	3.5	5.0	5.0	3.15	1K1	500
	RDE5C2E330J1K1H03B	C0G	250	33pF	±5%	4.5	3.5	5.0	5.0	3.15	1K1	500
	RDE5C2E390J1K1H03B	C0G	250	39pF	±5%	4.5	3.5	5.0	5.0	3.15	1K1	500
	RDE5C2E470J1K1H03B	C0G	250	47pF	±5%	4.5	3.5	5.0	5.0	3.15	1K1	500
	RDE5C2E560J1K1H03B	C0G	250	56pF	±5%	4.5	3.5	5.0	5.0	3.15	1K1	500
	RDE5C2E680J1K1H03B	C0G	250	68pF	±5%	4.5	3.5	5.0	5.0	3.15	1K1	500
	RDE5C2E820J1K1H03B	C0G	250	82pF	±5%	4.5	3.5	5.0	5.0	3.15	1K1	500
	RDE5C2E101J1K1H03B	C0G	250	100pF	±5%	4.5	3.5	5.0	5.0	3.15	1K1	500
	RDE5C2E121J1K1H03B	C0G	250	120pF	±5%	4.5	3.5	5.0	5.0	3.15	1K1	500
	RDE5C2E151J1K1H03B	C0G	250	150pF	±5%	4.5	3.5	5.0	5.0	3.15	1K1	500
	RDE5C2E181J1K1H03B	C0G	250	180pF	±5%	4.5	3.5	5.0	5.0	3.15	1K1	500
	RDE5C2E221J1K1H03B	C0G	250	220pF	±5%	4.5	3.5	5.0	5.0	3.15	1K1	500
	RDE5C2E271J1K1H03B	C0G	250	270pF	±5%	4.5	3.5	5.0	5.0	3.15	1K1	500
	RDE5C2E331J1K1H03B	C0G	250	330pF	±5%	4.5	3.5	5.0	5.0	3.15	1K1	500
	RDE5C2E391J1K1H03B	C0G	250	390pF	±5%	4.5	3.5	5.0	5.0	3.15	1K1	500
	RDE5C2E471J1K1H03B	C0G	250	470pF	±5%	4.5	3.5	5.0	5.0	3.15	1K1	500
	RDE5C2E561J1K1H03B	C0G	250	560pF	±5%	4.5	3.5	5.0	5.0	3.15	1K1	500
	RDE5C2E681J1K1H03B	C0G	250	680pF	±5%	4.5	3.5	5.0	5.0	3.15	1K1	500
	RDE5C2E821J1K1H03B	C0G	250	820pF	±5%	4.5	3.5	5.0	5.0	3.15	1K1	500
	RDE5C2E102J1K1H03B	C0G	250	1000pF	±5%	4.5	3.5	5.0	5.0	3.15	1K1	500
	RDE5C2E122J1K1H03B	C0G	250	1200pF	±5%	4.5	3.5	5.0	5.0	3.15	1K1	500
	RDE5C2E152J1K1H03B	C0G	250	1500pF	±5%	4.5	3.5	5.0	5.0	3.15	1K1	500
	RDE5C2E182J1K1H03B	C0G	250	1800pF	±5%	4.5	3.5	5.0	5.0	3.15	1K1	500
	RDE5C2E222J1K1H03B	C0G	250	2200pF	±5%	4.5	3.5	5.0	5.0	3.15	1K1	500
	RDE5C2E272J1K1H03B	C0G	250	2700pF	±5%	4.5	3.5	5.0	5.0	3.15	1K1	500
	RDE5C2E332J1K1H03B	C0G	250	3300pF	±5%	4.5	3.5	5.0	5.0	3.15	1K1	500
	RDE5C2E392J1K1H03B	C0G	250	3900pF	±5%	4.5	3.5	5.0	5.0	3.15	1K1	500
	RDE5C2E472J1K1H03B	C0G	250	4700pF	±5%	4.5	3.5	5.0	5.0	3.15	1K1	500
	RDE5C2E562J1K1H03B	C0G	250	5600pF	±5%	4.5	3.5	5.0	5.0	3.15	1K1	500
	RDE5C2E682J1K1H03B	C0G	250	6800pF	±5%	4.5	3.5	5.0	5.0	3.15	1K1	500
	RDE5C2E822J1K1H03B	C0G	250	8200pF	±5%	4.5	3.5	5.0	5.0	3.15	1K1	500
	RDE5C2E103J1K1H03B	C0G	250	10000pF	±5%	4.5	3.5	5.0	5.0	3.15	1K1	500
	RDE5C2E123J2K1H03B	C0G	250	12000pF	±5%	5.5	4.0	6.0	5.0	3.15	2K1	500
	RDE5C2E153J2K1H03B	C0G	250	15000pF	±5%	5.5	4.0	6.0	5.0	3.15	2K1	500
	RDE5C2E183J2K1H03B	C0G	250	18000pF	±5%	5.5	4.0	6.0	5.0	3.15	2K1	500

- Inside Crimp
(Lead Style:K*)

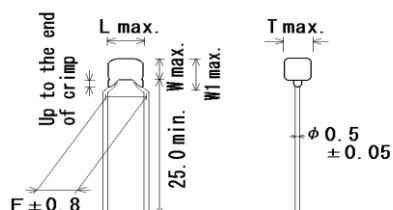

Unit : mm

Customer Part Number	Murata Part Number	T.C.	DC Rated Volt. (V)	Cap.	Cap. Tol.	Dimension (mm)					Dimension (LxW) Lead Style	Pack qty. (pcs)
						L	W	W1	F	T		
	RDE5C2E223J2K1H03B	C0G	250	22000pF	±5%	5.5	4.0	6.0	5.0	3.15	2K1	500
	RDE5C2J100J1K1H03B	C0G	630	10pF	±5%	4.5	3.5	5.0	5.0	3.15	1K1	500
	RDE5C2J120J1K1H03B	C0G	630	12pF	±5%	4.5	3.5	5.0	5.0	3.15	1K1	500
	RDE5C2J150J1K1H03B	C0G	630	15pF	±5%	4.5	3.5	5.0	5.0	3.15	1K1	500
	RDE5C2J180J1K1H03B	C0G	630	18pF	±5%	4.5	3.5	5.0	5.0	3.15	1K1	500
	RDE5C2J220J1K1H03B	C0G	630	22pF	±5%	4.5	3.5	5.0	5.0	3.15	1K1	500
	RDE5C2J270J1K1H03B	C0G	630	27pF	±5%	4.5	3.5	5.0	5.0	3.15	1K1	500
	RDE5C2J330J1K1H03B	C0G	630	33pF	±5%	4.5	3.5	5.0	5.0	3.15	1K1	500
	RDE5C2J390J1K1H03B	C0G	630	39pF	±5%	4.5	3.5	5.0	5.0	3.15	1K1	500
	RDE5C2J470J1K1H03B	C0G	630	47pF	±5%	4.5	3.5	5.0	5.0	3.15	1K1	500
	RDE5C2J560J1K1H03B	C0G	630	56pF	±5%	4.5	3.5	5.0	5.0	3.15	1K1	500
	RDE5C2J680J1K1H03B	C0G	630	68pF	±5%	4.5	3.5	5.0	5.0	3.15	1K1	500
	RDE5C2J820J1K1H03B	C0G	630	82pF	±5%	4.5	3.5	5.0	5.0	3.15	1K1	500
	RDE5C2J101J1K1H03B	C0G	630	100pF	±5%	4.5	3.5	5.0	5.0	3.15	1K1	500
	RDE5C2J121J1K1H03B	C0G	630	120pF	±5%	4.5	3.5	5.0	5.0	3.15	1K1	500
	RDE5C2J151J1K1H03B	C0G	630	150pF	±5%	4.5	3.5	5.0	5.0	3.15	1K1	500
	RDE5C2J181J1K1H03B	C0G	630	180pF	±5%	4.5	3.5	5.0	5.0	3.15	1K1	500
	RDE5C2J221J1K1H03B	C0G	630	220pF	±5%	4.5	3.5	5.0	5.0	3.15	1K1	500
	RDE5C2J271J1K1H03B	C0G	630	270pF	±5%	4.5	3.5	5.0	5.0	3.15	1K1	500
	RDE5C2J331J1K1H03B	C0G	630	330pF	±5%	4.5	3.5	5.0	5.0	3.15	1K1	500
	RDE5C2J391J1K1H03B	C0G	630	390pF	±5%	4.5	3.5	5.0	5.0	3.15	1K1	500
	RDE5C2J471J1K1H03B	C0G	630	470pF	±5%	4.5	3.5	5.0	5.0	3.15	1K1	500
	RDE5C2J561J1K1H03B	C0G	630	560pF	±5%	4.5	3.5	5.0	5.0	3.15	1K1	500
	RDE5C2J681J1K1H03B	C0G	630	680pF	±5%	4.5	3.5	5.0	5.0	3.15	1K1	500
	RDE5C2J821J1K1H03B	C0G	630	820pF	±5%	4.5	3.5	5.0	5.0	3.15	1K1	500
	RDE5C2J102J1K1H03B	C0G	630	1000pF	±5%	4.5	3.5	5.0	5.0	3.15	1K1	500
	RDE5C2J122J1K1H03B	C0G	630	1200pF	±5%	4.5	3.5	5.0	5.0	3.15	1K1	500
	RDE5C2J152J1K1H03B	C0G	630	1500pF	±5%	4.5	3.5	5.0	5.0	3.15	1K1	500
	RDE5C2J182J1K1H03B	C0G	630	1800pF	±5%	4.5	3.5	5.0	5.0	3.15	1K1	500
	RDE5C2J222J1K1H03B	C0G	630	2200pF	±5%	4.5	3.5	5.0	5.0	3.15	1K1	500
	RDE5C2J272J2K1H03B	C0G	630	2700pF	±5%	5.5	4.0	6.0	5.0	3.15	2K1	500
	RDE5C2J332J2K1H03B	C0G	630	3300pF	±5%	5.5	4.0	6.0	5.0	3.15	2K1	500
	RDE5C2J392J2K1H03B	C0G	630	3900pF	±5%	5.5	4.0	6.0	5.0	3.15	2K1	500
	RDE5C2J472J2K1H03B	C0G	630	4700pF	±5%	5.5	4.0	6.0	5.0	3.15	2K1	500
	RDE5C3A100J2K1H03B	C0G	1000	10pF	±5%	5.5	4.0	6.0	5.0	3.15	2K1	500
	RDE5C3A120J2K1H03B	C0G	1000	12pF	±5%	5.5	4.0	6.0	5.0	3.15	2K1	500
	RDE5C3A150J2K1H03B	C0G	1000	15pF	±5%	5.5	4.0	6.0	5.0	3.15	2K1	500
	RDE5C3A180J2K1H03B	C0G	1000	18pF	±5%	5.5	4.0	6.0	5.0	3.15	2K1	500
	RDE5C3A220J2K1H03B	C0G	1000	22pF	±5%	5.5	4.0	6.0	5.0	3.15	2K1	500
	RDE5C3A270J2K1H03B	C0G	1000	27pF	±5%	5.5	4.0	6.0	5.0	3.15	2K1	500

- Inside Crimp
(Lead Style:K*)

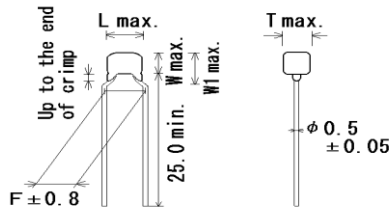

Unit : mm

Customer Part Number	Murata Part Number	T.C.	DC Rated Volt. (V)	Cap.	Cap. Tol.	Dimension (mm)					Dimension (LxW) Lead Style	Pack qty. (pcs)
						L	W	W1	F	T		
	RDE5C3A330J2K1H03B	C0G	1000	33pF	±5%	5.5	4.0	6.0	5.0	3.15	2K1	500
	RDE5C3A390J2K1H03B	C0G	1000	39pF	±5%	5.5	4.0	6.0	5.0	3.15	2K1	500
	RDE5C3A470J2K1H03B	C0G	1000	47pF	±5%	5.5	4.0	6.0	5.0	3.15	2K1	500
	RDE5C3A560J2K1H03B	C0G	1000	56pF	±5%	5.5	4.0	6.0	5.0	3.15	2K1	500
	RDE5C3A680J2K1H03B	C0G	1000	68pF	±5%	5.5	4.0	6.0	5.0	3.15	2K1	500
	RDE5C3A820J2K1H03B	C0G	1000	82pF	±5%	5.5	4.0	6.0	5.0	3.15	2K1	500
	RDE5C3A101J2K1H03B	C0G	1000	100pF	±5%	5.5	4.0	6.0	5.0	3.15	2K1	500
	RDE5C3A121J2K1H03B	C0G	1000	120pF	±5%	5.5	4.0	6.0	5.0	3.15	2K1	500
	RDE5C3A151J2K1H03B	C0G	1000	150pF	±5%	5.5	4.0	6.0	5.0	3.15	2K1	500
	RDE5C3A181J2K1H03B	C0G	1000	180pF	±5%	5.5	4.0	6.0	5.0	3.15	2K1	500
	RDE5C3A221J2K1H03B	C0G	1000	220pF	±5%	5.5	4.0	6.0	5.0	3.15	2K1	500
	RDE5C3A271J2K1H03B	C0G	1000	270pF	±5%	5.5	4.0	6.0	5.0	3.15	2K1	500
	RDE5C3A331J2K1H03B	C0G	1000	330pF	±5%	5.5	4.0	6.0	5.0	3.15	2K1	500
	RDE5C3A391J2K1H03B	C0G	1000	390pF	±5%	5.5	4.0	6.0	5.0	3.15	2K1	500
	RDE5C3A471J2K1H03B	C0G	1000	470pF	±5%	5.5	4.0	6.0	5.0	3.15	2K1	500
	RDE5C3A561J2K1H03B	C0G	1000	560pF	±5%	5.5	4.0	6.0	5.0	3.15	2K1	500
	RDE5C3A681J2K1H03B	C0G	1000	680pF	±5%	5.5	4.0	6.0	5.0	3.15	2K1	500
	RDE5C3A821J2K1H03B	C0G	1000	820pF	±5%	5.5	4.0	6.0	5.0	3.15	2K1	500
	RDE5C3A102J2K1H03B	C0G	1000	1000pF	±5%	5.5	4.0	6.0	5.0	3.15	2K1	500

• Inside Crimp Taping
(Lead Style: M*)

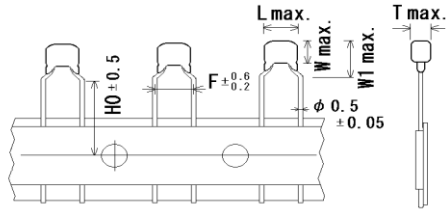

Unit : mm

Customer Part Number	Murata Part Number	T.C.	DC Rated Volt. (V)	Cap.	Cap. Tol.	Dimension (mm)						Dimension (LxW) Lead Style	Pack qty. (pcs)
						L	W	W1	F	T	H/H0		
	RDE5C2E100J1M1H03A	C0G	250	10pF	±5%	4.5	3.5	5.0	5.0	3.15	16.0	1M1	2000
	RDE5C2E120J1M1H03A	C0G	250	12pF	±5%	4.5	3.5	5.0	5.0	3.15	16.0	1M1	2000
	RDE5C2E150J1M1H03A	C0G	250	15pF	±5%	4.5	3.5	5.0	5.0	3.15	16.0	1M1	2000
	RDE5C2E180J1M1H03A	C0G	250	18pF	±5%	4.5	3.5	5.0	5.0	3.15	16.0	1M1	2000
	RDE5C2E220J1M1H03A	C0G	250	22pF	±5%	4.5	3.5	5.0	5.0	3.15	16.0	1M1	2000
	RDE5C2E270J1M1H03A	C0G	250	27pF	±5%	4.5	3.5	5.0	5.0	3.15	16.0	1M1	2000
	RDE5C2E330J1M1H03A	C0G	250	33pF	±5%	4.5	3.5	5.0	5.0	3.15	16.0	1M1	2000
	RDE5C2E390J1M1H03A	C0G	250	39pF	±5%	4.5	3.5	5.0	5.0	3.15	16.0	1M1	2000
	RDE5C2E470J1M1H03A	C0G	250	47pF	±5%	4.5	3.5	5.0	5.0	3.15	16.0	1M1	2000
	RDE5C2E560J1M1H03A	C0G	250	56pF	±5%	4.5	3.5	5.0	5.0	3.15	16.0	1M1	2000
	RDE5C2E680J1M1H03A	C0G	250	68pF	±5%	4.5	3.5	5.0	5.0	3.15	16.0	1M1	2000
	RDE5C2E820J1M1H03A	C0G	250	82pF	±5%	4.5	3.5	5.0	5.0	3.15	16.0	1M1	2000
	RDE5C2E101J1M1H03A	C0G	250	100pF	±5%	4.5	3.5	5.0	5.0	3.15	16.0	1M1	2000
	RDE5C2E121J1M1H03A	C0G	250	120pF	±5%	4.5	3.5	5.0	5.0	3.15	16.0	1M1	2000
	RDE5C2E151J1M1H03A	C0G	250	150pF	±5%	4.5	3.5	5.0	5.0	3.15	16.0	1M1	2000
	RDE5C2E181J1M1H03A	C0G	250	180pF	±5%	4.5	3.5	5.0	5.0	3.15	16.0	1M1	2000
	RDE5C2E221J1M1H03A	C0G	250	220pF	±5%	4.5	3.5	5.0	5.0	3.15	16.0	1M1	2000
	RDE5C2E271J1M1H03A	C0G	250	270pF	±5%	4.5	3.5	5.0	5.0	3.15	16.0	1M1	2000
	RDE5C2E331J1M1H03A	C0G	250	330pF	±5%	4.5	3.5	5.0	5.0	3.15	16.0	1M1	2000
	RDE5C2E391J1M1H03A	C0G	250	390pF	±5%	4.5	3.5	5.0	5.0	3.15	16.0	1M1	2000
	RDE5C2E471J1M1H03A	C0G	250	470pF	±5%	4.5	3.5	5.0	5.0	3.15	16.0	1M1	2000
	RDE5C2E561J1M1H03A	C0G	250	560pF	±5%	4.5	3.5	5.0	5.0	3.15	16.0	1M1	2000
	RDE5C2E681J1M1H03A	C0G	250	680pF	±5%	4.5	3.5	5.0	5.0	3.15	16.0	1M1	2000
	RDE5C2E821J1M1H03A	C0G	250	820pF	±5%	4.5	3.5	5.0	5.0	3.15	16.0	1M1	2000
	RDE5C2E102J1M1H03A	C0G	250	1000pF	±5%	4.5	3.5	5.0	5.0	3.15	16.0	1M1	2000
	RDE5C2E122J1M1H03A	C0G	250	1200pF	±5%	4.5	3.5	5.0	5.0	3.15	16.0	1M1	2000
	RDE5C2E152J1M1H03A	C0G	250	1500pF	±5%	4.5	3.5	5.0	5.0	3.15	16.0	1M1	2000
	RDE5C2E182J1M1H03A	C0G	250	1800pF	±5%	4.5	3.5	5.0	5.0	3.15	16.0	1M1	2000
	RDE5C2E222J1M1H03A	C0G	250	2200pF	±5%	4.5	3.5	5.0	5.0	3.15	16.0	1M1	2000
	RDE5C2E272J1M1H03A	C0G	250	2700pF	±5%	4.5	3.5	5.0	5.0	3.15	16.0	1M1	2000
	RDE5C2E332J1M1H03A	C0G	250	3300pF	±5%	4.5	3.5	5.0	5.0	3.15	16.0	1M1	2000
	RDE5C2E392J1M1H03A	C0G	250	3900pF	±5%	4.5	3.5	5.0	5.0	3.15	16.0	1M1	2000
	RDE5C2E472J1M1H03A	C0G	250	4700pF	±5%	4.5	3.5	5.0	5.0	3.15	16.0	1M1	2000
	RDE5C2E562J1M1H03A	C0G	250	5600pF	±5%	4.5	3.5	5.0	5.0	3.15	16.0	1M1	2000
	RDE5C2E682J1M1H03A	C0G	250	6800pF	±5%	4.5	3.5	5.0	5.0	3.15	16.0	1M1	2000
	RDE5C2E822J1M1H03A	C0G	250	8200pF	±5%	4.5	3.5	5.0	5.0	3.15	16.0	1M1	2000
	RDE5C2E103J1M1H03A	C0G	250	10000pF	±5%	4.5	3.5	5.0	5.0	3.15	16.0	1M1	2000
	RDE5C2E123J2M1H03A	C0G	250	12000pF	±5%	5.5	4.0	6.0	5.0	3.15	16.0	2M1	2000
	RDE5C2E153J2M1H03A	C0G	250	15000pF	±5%	5.5	4.0	6.0	5.0	3.15	16.0	2M1	2000
	RDE5C2E183J2M1H03A	C0G	250	18000pF	±5%	5.5	4.0	6.0	5.0	3.15	16.0	2M1	2000

• Inside Crimp Taping
(Lead Style: M*)

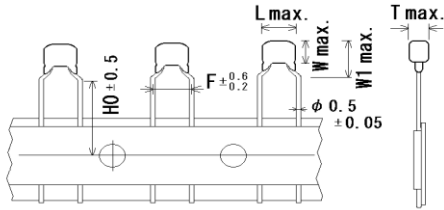

Unit : mm

Customer Part Number	Murata Part Number	T.C.	DC Rated Volt. (V)	Cap.	Cap. Tol.	Dimension (mm)						Dimension (LxW) Lead Style	Pack qty. (pcs)
						L	W	W1	F	T	H/H0		
	RDE5C2E223J2M1H03A	C0G	250	22000pF	±5%	5.5	4.0	6.0	5.0	3.15	16.0	2M1	2000
	RDE5C2J100J1M1H03A	C0G	630	10pF	±5%	4.5	3.5	5.0	5.0	3.15	16.0	1M1	2000
	RDE5C2J120J1M1H03A	C0G	630	12pF	±5%	4.5	3.5	5.0	5.0	3.15	16.0	1M1	2000
	RDE5C2J150J1M1H03A	C0G	630	15pF	±5%	4.5	3.5	5.0	5.0	3.15	16.0	1M1	2000
	RDE5C2J180J1M1H03A	C0G	630	18pF	±5%	4.5	3.5	5.0	5.0	3.15	16.0	1M1	2000
	RDE5C2J220J1M1H03A	C0G	630	22pF	±5%	4.5	3.5	5.0	5.0	3.15	16.0	1M1	2000
	RDE5C2J270J1M1H03A	C0G	630	27pF	±5%	4.5	3.5	5.0	5.0	3.15	16.0	1M1	2000
	RDE5C2J330J1M1H03A	C0G	630	33pF	±5%	4.5	3.5	5.0	5.0	3.15	16.0	1M1	2000
	RDE5C2J390J1M1H03A	C0G	630	39pF	±5%	4.5	3.5	5.0	5.0	3.15	16.0	1M1	2000
	RDE5C2J470J1M1H03A	C0G	630	47pF	±5%	4.5	3.5	5.0	5.0	3.15	16.0	1M1	2000
	RDE5C2J560J1M1H03A	C0G	630	56pF	±5%	4.5	3.5	5.0	5.0	3.15	16.0	1M1	2000
	RDE5C2J680J1M1H03A	C0G	630	68pF	±5%	4.5	3.5	5.0	5.0	3.15	16.0	1M1	2000
	RDE5C2J820J1M1H03A	C0G	630	82pF	±5%	4.5	3.5	5.0	5.0	3.15	16.0	1M1	2000
	RDE5C2J101J1M1H03A	C0G	630	100pF	±5%	4.5	3.5	5.0	5.0	3.15	16.0	1M1	2000
	RDE5C2J121J1M1H03A	C0G	630	120pF	±5%	4.5	3.5	5.0	5.0	3.15	16.0	1M1	2000
	RDE5C2J151J1M1H03A	C0G	630	150pF	±5%	4.5	3.5	5.0	5.0	3.15	16.0	1M1	2000
	RDE5C2J181J1M1H03A	C0G	630	180pF	±5%	4.5	3.5	5.0	5.0	3.15	16.0	1M1	2000
	RDE5C2J221J1M1H03A	C0G	630	220pF	±5%	4.5	3.5	5.0	5.0	3.15	16.0	1M1	2000
	RDE5C2J271J1M1H03A	C0G	630	270pF	±5%	4.5	3.5	5.0	5.0	3.15	16.0	1M1	2000
	RDE5C2J331J1M1H03A	C0G	630	330pF	±5%	4.5	3.5	5.0	5.0	3.15	16.0	1M1	2000
	RDE5C2J391J1M1H03A	C0G	630	390pF	±5%	4.5	3.5	5.0	5.0	3.15	16.0	1M1	2000
	RDE5C2J471J1M1H03A	C0G	630	470pF	±5%	4.5	3.5	5.0	5.0	3.15	16.0	1M1	2000
	RDE5C2J561J1M1H03A	C0G	630	560pF	±5%	4.5	3.5	5.0	5.0	3.15	16.0	1M1	2000
	RDE5C2J681J1M1H03A	C0G	630	680pF	±5%	4.5	3.5	5.0	5.0	3.15	16.0	1M1	2000
	RDE5C2J821J1M1H03A	C0G	630	820pF	±5%	4.5	3.5	5.0	5.0	3.15	16.0	1M1	2000
	RDE5C2J102J1M1H03A	C0G	630	1000pF	±5%	4.5	3.5	5.0	5.0	3.15	16.0	1M1	2000
	RDE5C2J122J1M1H03A	C0G	630	1200pF	±5%	4.5	3.5	5.0	5.0	3.15	16.0	1M1	2000
	RDE5C2J152J1M1H03A	C0G	630	1500pF	±5%	4.5	3.5	5.0	5.0	3.15	16.0	1M1	2000
	RDE5C2J182J1M1H03A	C0G	630	1800pF	±5%	4.5	3.5	5.0	5.0	3.15	16.0	1M1	2000
	RDE5C2J222J1M1H03A	C0G	630	2200pF	±5%	4.5	3.5	5.0	5.0	3.15	16.0	1M1	2000
	RDE5C2J272J2M1H03A	C0G	630	2700pF	±5%	5.5	4.0	6.0	5.0	3.15	16.0	2M1	2000
	RDE5C2J332J2M1H03A	C0G	630	3300pF	±5%	5.5	4.0	6.0	5.0	3.15	16.0	2M1	2000
	RDE5C2J392J2M1H03A	C0G	630	3900pF	±5%	5.5	4.0	6.0	5.0	3.15	16.0	2M1	2000
	RDE5C2J472J2M1H03A	C0G	630	4700pF	±5%	5.5	4.0	6.0	5.0	3.15	16.0	2M1	2000
	RDE5C3A100J2M1H03A	C0G	1000	10pF	±5%	5.5	4.0	6.0	5.0	3.15	16.0	2M1	2000
	RDE5C3A120J2M1H03A	C0G	1000	12pF	±5%	5.5	4.0	6.0	5.0	3.15	16.0	2M1	2000
	RDE5C3A150J2M1H03A	C0G	1000	15pF	±5%	5.5	4.0	6.0	5.0	3.15	16.0	2M1	2000
	RDE5C3A180J2M1H03A	C0G	1000	18pF	±5%	5.5	4.0	6.0	5.0	3.15	16.0	2M1	2000
	RDE5C3A220J2M1H03A	C0G	1000	22pF	±5%	5.5	4.0	6.0	5.0	3.15	16.0	2M1	2000
	RDE5C3A270J2M1H03A	C0G	1000	27pF	±5%	5.5	4.0	6.0	5.0	3.15	16.0	2M1	2000

• Inside Crimp Taping
(Lead Style: M*)

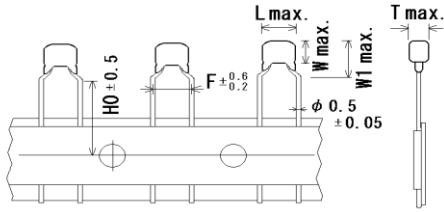

Unit : mm

Customer Part Number	Murata Part Number	T.C.	DC Rated Volt. (V)	Cap.	Cap. Tol.	Dimension (mm)						Dimension (LxW) Lead Style	Pack qty. (pcs)
						L	W	W1	F	T	H/H0		
	RDE5C3A330J2M1H03A	C0G	1000	33pF	±5%	5.5	4.0	6.0	5.0	3.15	16.0	2M1	2000
	RDE5C3A390J2M1H03A	C0G	1000	39pF	±5%	5.5	4.0	6.0	5.0	3.15	16.0	2M1	2000
	RDE5C3A470J2M1H03A	C0G	1000	47pF	±5%	5.5	4.0	6.0	5.0	3.15	16.0	2M1	2000
	RDE5C3A560J2M1H03A	C0G	1000	56pF	±5%	5.5	4.0	6.0	5.0	3.15	16.0	2M1	2000
	RDE5C3A680J2M1H03A	C0G	1000	68pF	±5%	5.5	4.0	6.0	5.0	3.15	16.0	2M1	2000
	RDE5C3A820J2M1H03A	C0G	1000	82pF	±5%	5.5	4.0	6.0	5.0	3.15	16.0	2M1	2000
	RDE5C3A101J2M1H03A	C0G	1000	100pF	±5%	5.5	4.0	6.0	5.0	3.15	16.0	2M1	2000
	RDE5C3A121J2M1H03A	C0G	1000	120pF	±5%	5.5	4.0	6.0	5.0	3.15	16.0	2M1	2000
	RDE5C3A151J2M1H03A	C0G	1000	150pF	±5%	5.5	4.0	6.0	5.0	3.15	16.0	2M1	2000
	RDE5C3A181J2M1H03A	C0G	1000	180pF	±5%	5.5	4.0	6.0	5.0	3.15	16.0	2M1	2000
	RDE5C3A221J2M1H03A	C0G	1000	220pF	±5%	5.5	4.0	6.0	5.0	3.15	16.0	2M1	2000
	RDE5C3A271J2M1H03A	C0G	1000	270pF	±5%	5.5	4.0	6.0	5.0	3.15	16.0	2M1	2000
	RDE5C3A331J2M1H03A	C0G	1000	330pF	±5%	5.5	4.0	6.0	5.0	3.15	16.0	2M1	2000
	RDE5C3A391J2M1H03A	C0G	1000	390pF	±5%	5.5	4.0	6.0	5.0	3.15	16.0	2M1	2000
	RDE5C3A471J2M1H03A	C0G	1000	470pF	±5%	5.5	4.0	6.0	5.0	3.15	16.0	2M1	2000
	RDE5C3A561J2M1H03A	C0G	1000	560pF	±5%	5.5	4.0	6.0	5.0	3.15	16.0	2M1	2000
	RDE5C3A681J2M1H03A	C0G	1000	680pF	±5%	5.5	4.0	6.0	5.0	3.15	16.0	2M1	2000
	RDE5C3A821J2M1H03A	C0G	1000	820pF	±5%	5.5	4.0	6.0	5.0	3.15	16.0	2M1	2000
	RDE5C3A102J2M1H03A	C0G	1000	1000pF	±5%	5.5	4.0	6.0	5.0	3.15	16.0	2M1	2000

Reference only

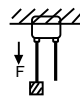
5.Specification																
No.	Test Item		Specification	Test Method (Ref. Standard:JIS C 5101(all parts), IEC60384(all parts))												
1	Appearance		No defects or abnormalities.	Visual inspection.												
2	Dimension and Marking		Within the specified dimensions and Marking.	Visual inspection, Using Caliper.												
3	Dielectric Strength	Between Terminals	No defects or abnormalities.	The capacitor should not be damaged when voltage of in Table is applied between the terminations for 1 to 5 seconds. (Charge/Discharge current $\leq 50\text{mA}$) <table border="1" style="margin: 10px auto;"><thead><tr><th>Rated voltage</th><th>Test voltage</th></tr></thead><tbody><tr><td>DC250V</td><td>200% of the rated voltage</td></tr><tr><td>DC630V</td><td>150% of the rated voltage</td></tr><tr><td>DC1kV</td><td>130% of the rated voltage</td></tr></tbody></table>	Rated voltage	Test voltage	DC250V	200% of the rated voltage	DC630V	150% of the rated voltage	DC1kV	130% of the rated voltage				
	Rated voltage	Test voltage														
DC250V	200% of the rated voltage															
DC630V	150% of the rated voltage															
DC1kV	130% of the rated voltage															
		Terminal To External Resin	No defects or abnormalities.	The capacitor is placed in a container with metal balls of 1mm diameter so that each terminal, short-circuit, is kept approximately 2mm from the balls, and voltage in Table is impressed for 1 to 5 seconds between capacitor terminals and metal balls. (Charge/Discharge current $\leq 50\text{mA}$) <table border="1" style="margin: 10px auto;"><thead><tr><th>Rated voltage</th><th>Test voltage</th></tr></thead><tbody><tr><td>DC250V</td><td>DC500V</td></tr><tr><td>DC630V·DC1kV</td><td>DC1300V</td></tr></tbody></table>	Rated voltage	Test voltage	DC250V	DC500V	DC630V·DC1kV	DC1300V						
Rated voltage	Test voltage															
DC250V	DC500V															
DC630V·DC1kV	DC1300V															
4	Insulation Resistance (I.R.)	Between Terminals	10,000M Ω or 500M Ω · μF min. (Whichever is smaller)	The insulation resistance should be measured with DC500 \pm 50V (DC250 \pm 25V in case of rated voltage : DC250V) at normal temperature and humidity and within 2 minutes of charging. (Charge/Discharge current $\leq 50\text{mA}$)												
5	Capacitance		Within the specified tolerance.	The capacitance, Q should be measured at 25°C at the frequency and voltage shown in the table. <table border="1" style="margin: 10px auto;"><thead><tr><th>Nominal Cap.</th><th>Frequency</th><th>Voltage</th></tr></thead><tbody><tr><td>C \leq 1000pF</td><td>1\pm0.2MHz</td><td>AC0.5 to 5V(r.m.s.)</td></tr><tr><td>C > 1000pF</td><td>1\pm0.2kHz</td><td>AC1\pm0.2V(r.m.s.)</td></tr></tbody></table>	Nominal Cap.	Frequency	Voltage	C \leq 1000pF	1 \pm 0.2MHz	AC0.5 to 5V(r.m.s.)	C > 1000pF	1 \pm 0.2kHz	AC1 \pm 0.2V(r.m.s.)			
Nominal Cap.	Frequency	Voltage														
C \leq 1000pF	1 \pm 0.2MHz	AC0.5 to 5V(r.m.s.)														
C > 1000pF	1 \pm 0.2kHz	AC1 \pm 0.2V(r.m.s.)														
6	Q		30pF \leq C : Q \geq 1,000 30pF > C : Q \geq 400+20C C : Nominal Capacitance (pF)													
7	Capacitance Temperature Characteristics		Within the specified Tolerance. 25°C to 125°C : 0 \pm 30ppm/°C -55°C to 25°C : 0+30/-72ppm/°C	The capacitance change should be measured after 5 minutes at each specified temperature stage. The temperature coefficient is determined using the capacitance measured in step 3 as a reference. When cycling the temperature sequentially from step 1 through 5 (-55°C to 125°C) the capacitance should be within the specified tolerance for the temperature coefficient. <table border="1" style="margin: 10px auto;"><thead><tr><th>Step</th><th>Temperature(°C)</th></tr></thead><tbody><tr><td>1</td><td>25\pm2</td></tr><tr><td>2</td><td>-55\pm3</td></tr><tr><td>3</td><td>25\pm2</td></tr><tr><td>4</td><td>125\pm3</td></tr><tr><td>5</td><td>25\pm2</td></tr></tbody></table>	Step	Temperature(°C)	1	25 \pm 2	2	-55 \pm 3	3	25 \pm 2	4	125 \pm 3	5	25 \pm 2
Step	Temperature(°C)															
1	25 \pm 2															
2	-55 \pm 3															
3	25 \pm 2															
4	125 \pm 3															
5	25 \pm 2															
8	Terminal Strength	Tensile Strength	Termination not to be broken or loosened.	As in the figure, fix the capacitor body, apply the force gradually to each lead in the radial direction of the capacitor until reaching 10N and then keep applied the force for 10 \pm 1 seconds. 												
		Bending Strength	Termination not to be broken or loosened.	Each lead wire should be subjected to a force of 2.5N and then be bent 90° at the point of egress in one direction. Each wire is then returned to the original position and bent 90° in the opposite direction at the rate of one bend per 2 to 3 seconds.												
9	Vibration Resistance	Appearance	No defects or abnormalities.	The capacitor should be subjected to a simple harmonic motion having a total amplitude of 1.5mm, the frequency being varied uniformly between the approximate limits of 10Hz and 55Hz. The frequency range, from 10Hz to 55Hz and return to 10Hz, shall be traversed in approximately 1 minute. This motion shall be applied for a period of 2 hours in each 3 mutually perpendicular directions (total of 6 hours).												
		Capacitance	Within the specified tolerance.													
		Q	30pF \leq C : Q \geq 1,000 30pF > C : Q \geq 400+20C C : Nominal Capacitance (pF)													

Reference only

No.	Test Item	Specification	Test Method (Ref. Standard: JIS C 5101(all parts), IEC60384(all parts))															
10	Solderability	Solder is deposited on unintermittingly immersed portion in axial direction covering 3/4 or more in circumferential direction of lead wires.	The terminal of capacitor is dipped into a solution of rosin ethanol (25% rosin in weight proportion). Immerse in solder solution for 2±0.5 seconds. In both cases the depth of dipping is up to about 1.5 to 2mm from the terminal body. Temp. of solder : 245±5°C (Sn-3.0Ag-0.5Cu)															
11-1	Resistance to Soldering Heat (Non-Preheat)	Appearance	The lead wires should be immersed in the melted solder 1.5 to 2.0mm from the root of terminal at 260±5°C for 10±1 seconds. • Post-treatment Capacitor should be stored for 24±2 hours at *room condition.															
		Capacitance																
		Change																
		Dielectric Strength (Between terminals)																
11-2	Resistance to Soldering Heat (On-Preheat)	Appearance	First the capacitor should be stored at 120+0/-5°C for 60+0/-5 seconds. Then, the lead wires should be immersed in the melted solder 1.5 to 2.0mm from the root of terminal at 260±5°C for 7.5+0/-1 seconds. • Post-treatment Capacitor should be stored for 24±2 hours at *room condition.															
		Capacitance																
		Change																
		Dielectric Strength (Between terminals)																
11-3	Resistance to Soldering Heat (soldering iron method)	Appearance	Test condition Temperature of iron-tip : 350±10°C Soldering time : 3.5±0.5 seconds Soldering position Straight Lead : 1.5 to 2.0mm from the root of terminal. Crimp Lead : 1.5 to 2.0mm from the end of bend. • Post-treatment Capacitor should be stored for 24±2 hours at *room condition.															
		Capacitance																
		Change																
		Dielectric Strength (Between terminals)																
12	Temperature Cycle	Appearance	Repeat 5 cycles according to the 4 heat treatments listed in the minutes at each specified temperature stage. The temperature coefficient is determined using the															
		Capacitance																
		Change																
		Q																
		I.R.																
		Dielectric Strength (Between Terminals)																
<table border="1" style="margin-left: auto; margin-right: auto;"> <thead> <tr> <th>Step</th> <th>1</th> <th>2</th> <th>3</th> <th>4</th> </tr> </thead> <tbody> <tr> <td>Temp. (°C)</td> <td>Min. Operating Temp. ±3</td> <td>Room Temp.</td> <td>Max. Operating Temp. ±3</td> <td>Room Temp.</td> </tr> <tr> <td>Time (min.)</td> <td>30±3</td> <td>3 max.</td> <td>30±3</td> <td>3 max.</td> </tr> </tbody> </table>				Step	1	2	3	4	Temp. (°C)	Min. Operating Temp. ±3	Room Temp.	Max. Operating Temp. ±3	Room Temp.	Time (min.)	30±3	3 max.	30±3	3 max.
Step	1	2	3	4														
Temp. (°C)	Min. Operating Temp. ±3	Room Temp.	Max. Operating Temp. ±3	Room Temp.														
Time (min.)	30±3	3 max.	30±3	3 max.														
13	Humidity (Steady State)	Appearance	Set the capacitor at 40±2°C and relative humidity 90 to 95% for 500+24/-0 hours. Remove and set for 24±2 hours at *room condition, then measure.															
		Capacitance																
		Change																
		Q																
		I.R.																

* "room condition" Temperature : 15 to 35°C, Relative humidity : 45 to 75%, Atmosphere pressure : 86 to 106kPa

Reference only

No.	Test Item	Specification	Test Method (Ref. Standard:JIS C 5101(all parts), IEC60384(all parts))						
14	Humidity Load	Appearance	No defects or abnormalities.						
		Capacitance Change	Within $\pm 7.5\%$ or $\pm 0.75\text{pF}$ (Whichever is larger)						
		Q	$30\text{pF} \leq C : Q \geq 200$ $30\text{pF} > C : Q \geq 100+10/3$ C : Nominal Capacitance (pF)						
		I.R.	$500\text{M}\Omega$ or $25\text{M}\Omega \cdot \mu\text{F}$ min. (Whichever is smaller)						
Apply the rated voltage at $40 \pm 2^\circ\text{C}$ and relative humidity of 90 to 95% for 500+24/-0 hours. Remove and set for 24 \pm 2 hours at *room condition, then measure. (Charge/Discharge current $\leq 50\text{mA}$.)									
15	High Temperature Load	Appearance	No defects or abnormalities.						
		Capacitance Change	Within $\pm 3\%$ or $\pm 0.3\text{pF}$ (Whichever is larger)						
		Q	$30\text{pF} \leq C : Q \geq 350$ $10\text{pF} \leq C < 30\text{pF} : Q \geq 275+5C/2$ $10\text{pF} > C : Q \geq 200+10C$ C : Nominal Capacitance (pF)						
		I.R.	$1,000\text{M}\Omega$ or $50\text{M}\Omega \cdot \mu\text{F}$ min. (Whichever is smaller)						
Apply voltage in Table at the maximum operating temperature $\pm 3^\circ\text{C}$ for 1000+48/-0 hours. Remove and set for 24 \pm 2 hours at *room condition, then measure. (Charge/Discharge current $\leq 50\text{mA}$.)									
		<table border="1"> <thead> <tr> <th>Rated voltage</th> <th>Test voltage</th> </tr> </thead> <tbody> <tr> <td>DC250V</td> <td>150% of the rated voltage</td> </tr> <tr> <td>DC630V, DC1kV</td> <td>120% of the rated voltage</td> </tr> </tbody> </table>		Rated voltage	Test voltage	DC250V	150% of the rated voltage	DC630V, DC1kV	120% of the rated voltage
Rated voltage	Test voltage								
DC250V	150% of the rated voltage								
DC630V, DC1kV	120% of the rated voltage								
16	Solvent Resistance	Appearance	No defects or abnormalities.						
		Marking	Legible						
The capacitor should be fully immersed, unagitated, in reagent at 20 to 25°C for 30 \pm 5 seconds and then remove gently. Marking on the surface of the capacitor shall immediately be visually examined. Regent : Isopropyl alcohol									

* "room condition" Temperature : 15 to 35°C, Relative humidity : 45 to 75%, Atmosphere pressure : 86 to 106kPa

6. Packing specification

- Bulk type (Package : B)

The size of packing case and packing way

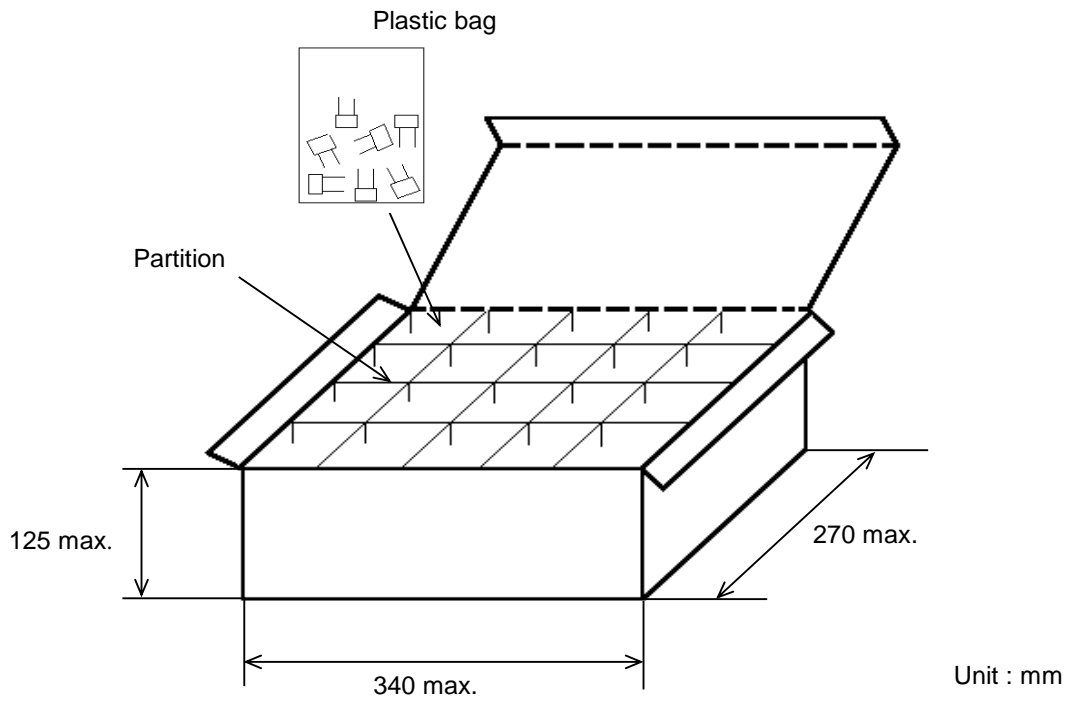

$$\text{The number of packing} = {}^*1 \text{ Packing quantity} \times {}^*2 n$$

*1 : Please refer to [Part number list].

*2 : Standard n = 20 (bag)

Note)

The outer package and the number of outer packing be changed by the order getting amount.

• Ammo pack taping type (Package : A)

- The tape with capacitors is packed zigzag into a case.
- There should be 3 pitches and over without capacitors in leader and trailer.

The size of packing case and packing way

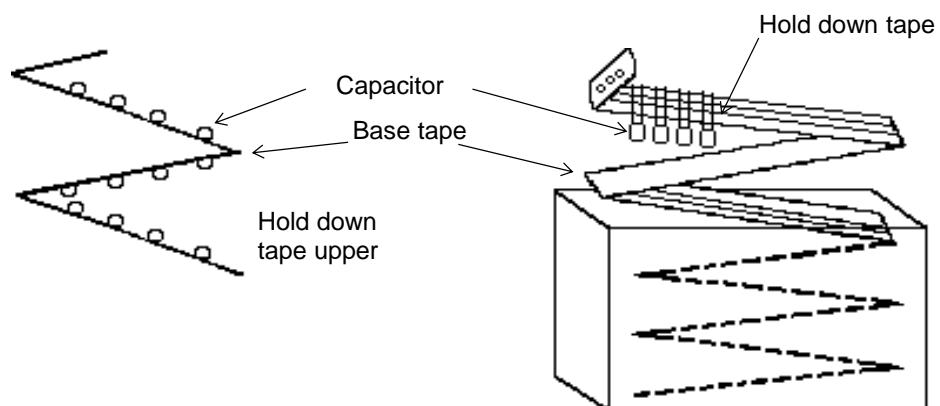
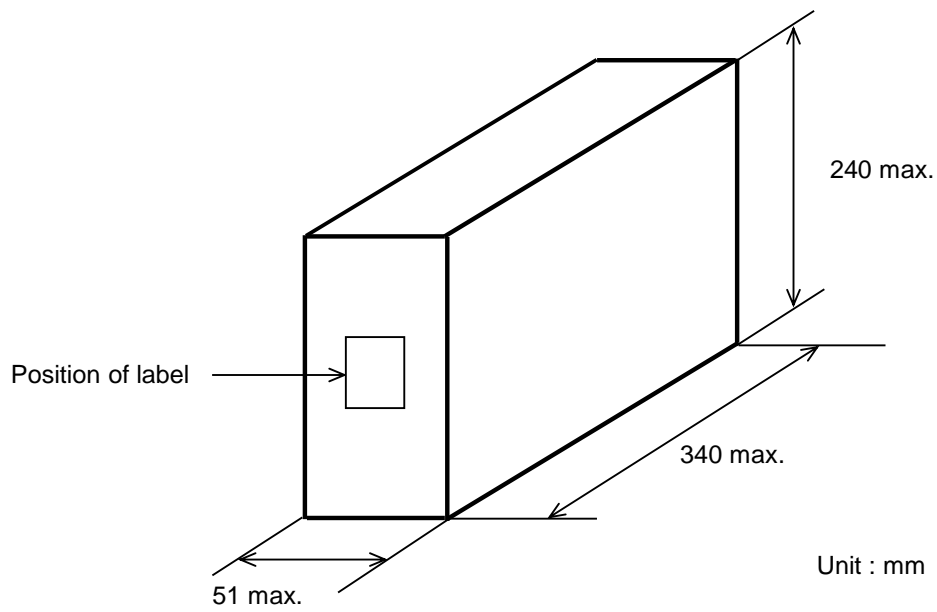

7. Taping specification

7-1. Dimension of capacitors on tape

Inside crimp taping type < Lead Style : M1 >

Pitch of component 12.7mm / Lead spacing 5.0mm

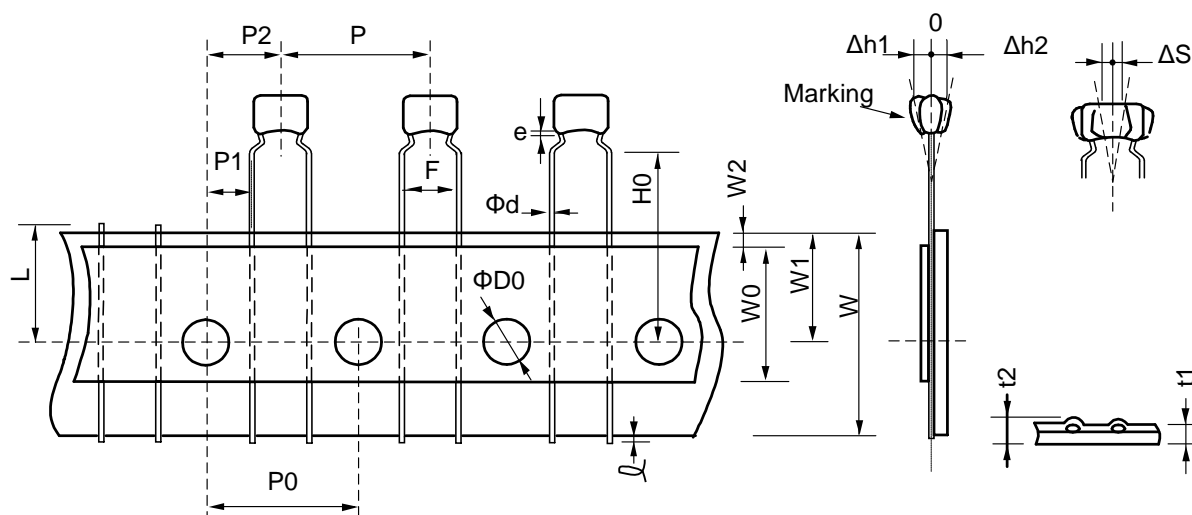

Unit : mm

Item	Code	Dimensions	Remarks
Pitch of component	P	12.7+/-1.0	
Pitch of sprocket hole	P0	12.7+/-0.2	
Lead spacing	F	5.0+0.6/-0.2	
Length from hole center to component center	P2	6.35+/-1.3	Deviation of progress direction
Length from hole center to lead	P1	3.85+/-0.7	
Deviation along tape, left or right defect	ΔS	0+/-2.0	They include deviation by lead bend
Carrier tape width	W	18.0+/-0.5	
Position of sprocket hole	W1	9.0+0/-0.5	Deviation of tape width direction
Lead distance between reference and bottom plane	H0	16.0+/-0.5	
Protrusion length	ℓ	0.5 max.	
Diameter of sprocket hole	ΦD0	4.0+/-0.1	
Lead diameter	Φd	0.5+/-0.05	
Total tape thickness	t1	0.6+/-0.3	They include hold down tape thickness
Total thickness of tape and lead wire	t2	1.5 max.	
Deviation across tape	Δh1	2.0 max. (Dimension code : W)	
	Δh2	1.0 max. (except as above)	
Portion to cut in case of defect	L	11.0+0/-1.0	
Hold down tape width	W0	9.5 min.	
Hold down tape position	W2	1.5+/-1.5	
Coating extension on lead	e	Up to the end of crimp	

7-2. Splicing way of tape

- 1) Adhesive force of tape is over 3N at test condition as below.

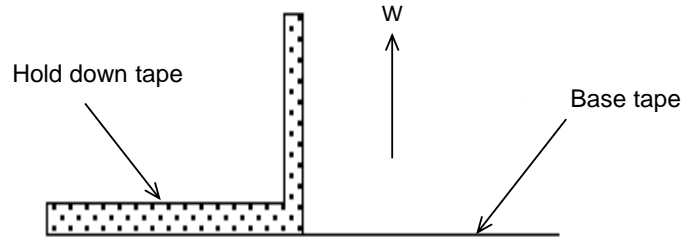

2) Splicing of tape

- (a) When base tape is spliced

- Base tape shall be spliced by cellophane tape.
- (Total tape thickness shall be less than 1.05mm.)

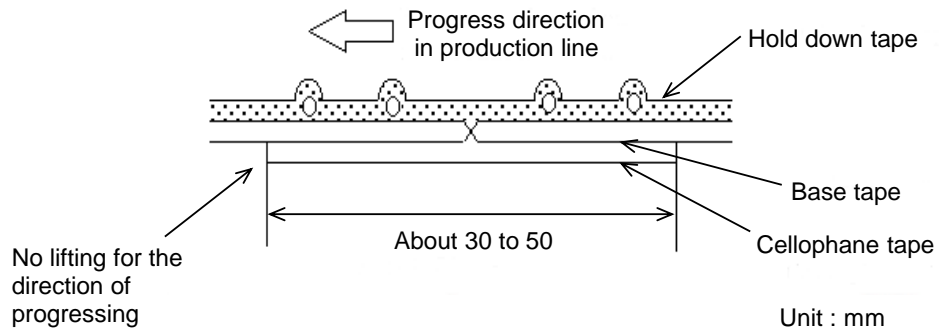

- (b) When hold down tape is spliced

- Hold down tape shall be spliced with overlapping.
- (Total tape thickness shall be less than 1.05mm.)

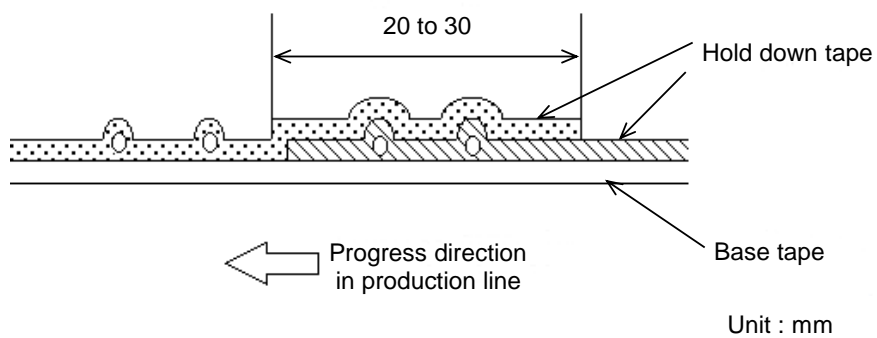

- (c) When both tape are spliced

- Base tape and hold down tape shall be spliced with splicing tape.

3) Missing components

- There should be no consecutive missing of more than three components.
- The number of missing components should be not more than 0.5 % of total components that should be present in a Ammo pack.

⚠ CAUTION**1. OPERATING VOLTAGE**

Do not apply a voltage to the capacitor that exceeds the rated voltage as called out in the specifications.

1-1. Applied voltage between the terminals of a capacitor shall be less than or equal to the rated voltage.

- (1) When AC voltage is superimposed on DC voltage, the zero-to-peak voltage shall not exceed the rated DC voltage. When AC voltage or pulse voltage is applied, the peak-to-peak voltage shall not exceed the rated DC voltage.
- (2) Abnormal voltages (surge voltage, static electricity, pulse voltage, etc.) shall not exceed the rated DC voltage.

Typical Voltage Applied to the DC Capacitor

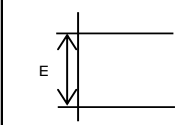
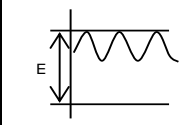
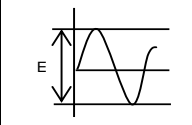
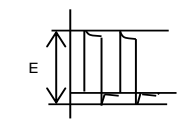
DC Voltage	DC+AC Voltage	AC Voltage	Pulse Voltage
			

(E: Maximum possible applied voltage.)

1-2. Influence of over voltage

Over voltage that is applied to the capacitor may result in an electrical short circuit caused by the breakdown of the internal dielectric layers. The time duration until breakdown depends on the applied voltage and the ambient temperature.

Use a safety standard certified capacitor in a power supply input circuit (AC filter), as it is also necessary to consider the withstand voltage and impulse withstand voltage defined for each device.

2. OPERATING TEMPERATURE AND SELF-GENERATED HEAT

Keep the surface temperature of a capacitor below the upper limit of its rated operating temperature range. Be sure to take into account the heat generated by the capacitor itself.

When the capacitor is used in a high-frequency current, pulse current or the like, it may have the self-generated heat due to dielectric-loss.

In case of Class 2 capacitors (Temp.Char. : X7R,X7S,X8L, etc.), applied voltage should be the load such as self-generated heat is within 20 °C on the condition of atmosphere temperature 25 °C.

Since the self-heating is low in the Class 1 capacitors (Temp.Char.: C0G,U2J,X8G, etc.), the allowable power becomes extremely high compared to the Class 2 capacitors.

However, when a load with self-heating of 20°C is applied at the rated voltage, the allowable power may be exceeded. Please confirm that there is no rising trend of the capacitor's surface temperature and that the surface temperature of the capacitor does not exceed the maximum operating temperature.

Excessive generation of heat may cause deterioration of the characteristics and reliability of the capacitor.

When measuring the self-heating temperature, be aware that accurate measurement may not be possible due to the following effects.

- The heat generated by other parts
- Air flow such as convection and cooling fans
- Temperature sensor used for measuring surface temperature of capacitor

In the case using a thermocouple, it is recommended that use a K thermocouple of $\Phi 0.1\text{mm}$ with less heat capacity.

3. FAIL-SAFE

Capacitors that are cracked by dropping or bending of the board may cause deterioration of the insulation resistance, and result in a short.

If the circuit being used may cause an electrical shock, smoke or fire when a capacitor is shorted, be sure to install fail-safe functions, such as a fuse, to prevent secondary accidents.

4. OPERATING AND STORAGE ENVIRONMENT

The insulating coating of capacitors does not form a perfect seal; therefore, do not use or store capacitors in a corrosive atmosphere, especially where chloride gas, sulfide gas, acid, alkali, salt or the like are present. And avoid exposure to moisture. Before cleaning, bonding, or molding this product, verify that these processes do not affect product quality by testing the performance of a cleaned, bonded or molded product in the intended equipment. Store the capacitors where the temperature and relative humidity do not exceed 5 to 40 °C and 20 to 70%. Use capacitors within 6 months.

Use capacitors within 6 months after delivered. Check the solderability after 6 months or more.

Due to moisture condensation caused by rapid humidity changes, or the photochemical change caused by direct sunlight on the terminal electrodes, the solderability and electrical performance may deteriorate. Do not store capacitors under direct sunlight or in high humidity conditions.

5. VIBRATION AND IMPACT

Do not expose a capacitor or its leads to excessive shock or vibration during use.

5-1. Mechanical shock due to being dropped may cause damage or a crack in the dielectric material of the capacitor.

Do not use a dropped capacitor because the quality and reliability may be deteriorated.

5-2. Excessive shock or vibration may cause to fatigue destruction of lead wires mounted on the circuit board. If necessary, take measures to hold a capacitor on the circuit boards by adhesive, molding resin or coating and other.

Please confirm there is no influence of holding measures on the product with an intended equipment.

6. SOLDERING

When soldering this product to a PCB/PWB, do not exceed the solder heat resistance specification of the capacitor. Subjecting this product to excessive heating could melt the internal junction solder and may result in thermal shocks that can crack the ceramic element.

Please verify that the soldering process does not affect the quality of capacitors.

6-1. Flow Soldering

Soldering temperature	: 260 °C max.
Soldering time	: 7.5 s max.
Preheating temperature	: 120 °C max.
Preheating time	: 60 s max.

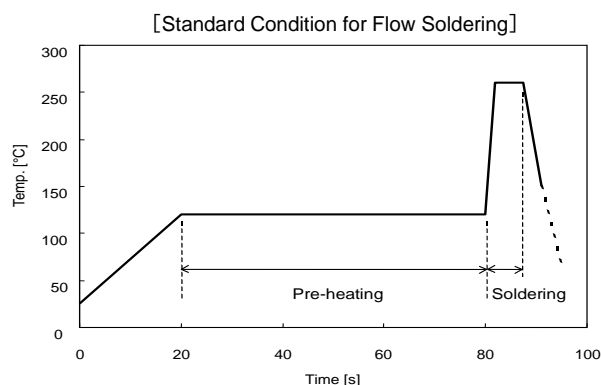

6-2. Reflow Soldering

Do not apply reflow soldering.

6-3. Soldering Iron

Temperature of iron-tip	: 350 °C max.
Soldering iron wattage	: 60 W max.
Soldering time	: 3.5 s max.

7. BONDING AND RESIN MOLDING, RESIN COAT

In case of bonding, molding or coating this product, verify that these processes do not affect the quality of capacitor by testing the performance of a bonded or molded product in the intended equipment.

In case of the amount of applications, dryness / hardening conditions of adhesives and molding resins containing organic solvents (ethyl acetate, methyl ethyl ketone, toluene, etc.) are unsuitable, the outer coating resin of a capacitor is damaged by the organic solvents and it may result, worst case, in a short circuit.

The variation in thickness of adhesive or molding resin may cause a outer coating resin cracking and/or ceramic element cracking of a capacitor in a temperature cycling.

8. TREATMENT AFTER BONDING AND RESIN MOLDING, RESIN COAT

When the outer coating is hot (over 100 °C) after soldering, it becomes soft and fragile.

So please be careful not to give it mechanical stress.

Failure to follow the above cautions may result, worst case, in a short circuit and cause fuming or partial dispersion when the product is used.

9. LIMITATION OF APPLICATIONS

The products listed in the specification(hereinafter the product(s) is called as the "Product(s)") are designed and manufactured for applications specified in the specification. (hereinafter called as the "Specific Application")

We shall not warrant anything in connection with the Products including fitness, performance, adequateness, safety, or quality, in the case of applications listed in from (1) to (11) written at the end of this precautions, which may generally require high performance, function, quality, management of production or safety.

Therefore, the Product shall be applied in compliance with the specific application.

WE DISCLAIM ANY LOSS AND DAMAGES ARISING FROM OR IN CONNECTION WITH THE PRODUCTS INCLUDING BUT NOT LIMITED TO THE CASE SUCH LOSS AND DAMAGES CAUSED BY THE UNEXPECTED ACCIDENT, IN EVENT THAT (i) THE PRODUCT IS APPLIED FOR THE PURPOSE WHICH IS NOT SPECIFIED AS THE SPECIFIC APPLICATION FOR THE PRODUCT, AND/OR (ii) THE PRODUCT IS APPLIED FOR ANY FOLLOWING APPLICATION PURPOSES FROM (1) TO (11) (EXCEPT THAT SUCH APPLICATION PURPOSE IS UNAMBIGUOUSLY SPECIFIED AS SPECIFIC APPLICATION FOR THE PRODUCT IN THE SPECIFICATION.*)

1. Aircraft equipment
2. Aerospace equipment
3. Undersea equipment
4. Power plant control equipment
5. Medical equipment
6. Transportation equipment
7. Traffic control equipment
8. Disaster prevention/security equipment
9. Industrial data-processing equipment
10. Combustion/explosion control equipment
11. Equipment with complexity and/or required reliability equivalent to the applications listed in the above.

For exploring information of the Products which will be compatible with the particular purpose other than those specified in the specification, please contact our sales offices, distribution agents, or trading companies with which you make a deal, or via our web contact form.

Contact form: <https://www.murata.com/contactform>

*We may design and manufacture particular Products for applications listed in (1) to (11). Provided that, in such case we shall unambiguously specify such Specific Application in the specification without any exception.

Therefore, any other documents and/or performances, whether exist or non-exist, shall not be deemed as the evidence to imply that we accept the applications listed in (1) to (11).

NOTICE**1. CLEANING**

- 1-1. Please evaluate the capacitor using actual cleaning equipment and conditions to confirm the quality, and select the solvent for cleaning.
- 1-2. Unsuitable cleaning may leave residual flux or other foreign substances, causing deterioration of electrical characteristics and the reliability of the capacitors.
- 1-3. To perform ultrasonic cleaning, observe the following conditions.
 - Rinse bath capacity : Output of 20 watts per liter or less.
 - Rinsing time : 5 min maximum.
 - Do not vibrate the PCB/PWB directly.
 - Excessive ultrasonic cleaning may lead to fatigue destruction of the lead wires.

2. SOLDERING AND MOUNTING

- 2-1. Insert the lead wire into the PCB with a distance appropriate to the lead space.
If the lead wires are inserted into different spacing holes, cracks may occur in the outer resin or the internal element.
- 2-2. When bending the lead wire, excessive force applied to the capacitor body may cause cracks in the outer resin or the internal element. Hold the lead wire closer to the capacitor body than the lead wire bending position with the fixture, then bend it.

(See the right figure)

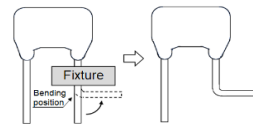

- 2-3. When cutting and clinching the lead wire, do not apply excessive force to the capacitor body.
- 2-4. When soldering, insert the lead wire into the PCB without mechanically stressing the lead wire.

3. CAPACITANCE CHANGE OF CAPACITORS

- Class 2 capacitors (Temp.Char. : X7R,X7S,X8L etc.)
Class 2 capacitors an aging characteristic, whereby the capacitor continually decreases its capacitance slightly if the capacitor leaves for a long time. Moreover, capacitance might change greatly depending on a surrounding temperature or an applied voltage. So, it is not likely to be able to use for the time constant circuit.
Please contact us if you need a detail information.

4. CHARACTERISTICS EVALUATION IN THE ACTUAL SYSTEM

- 4-1. Evaluate the capacitor in the actual system, to confirm that there is no problem with the performance and specification values in a finished product before using.
- 4-2. Since a voltage dependency and temperature dependency exists in the capacitance of Class 2 ceramic capacitors, the capacitance may change depending on the operating conditions in the actual system. Therefore, be sure to evaluate the various characteristics, such as the leakage current and noise absorptivity, which will affect the capacitance value of the capacitor.
- 4-3. In addition, voltages exceeding the predetermined surge may be applied to the capacitor by the inductance in the actual system.
Evaluate the surge resistance in the actual system as required.
- 4-4. When using Class 2 ceramic capacitors in AC or pulse circuits, the capacitor itself vibrates at specific frequencies and noise may be generated. Moreover, when the mechanical vibration or shock is added to capacitor, noise may occur.

⚠ NOTE

1. Please make sure that your product has been evaluated in view of your specifications with our product being mounted to your product.
2. You are requested not to use our product deviating from this product specification.

Looking for pricing, stock, or lifecycle information?

Click below to explore more details on WIN SOURCE:

- ⊖ [View RDE5C3A101J2M1H03A on WIN SOURCE](#)
- ⊖ [Murata Electronics North America Information](#)

Optimize Your Supply Chain with WIN SOURCE Solutions

- ✓ Global Sourcing Solution
- ✓ Obsolete Management
- ✓ Cost Control Management
- ✓ Shortage Management
- ✓ Alternative Solution
- ✓ Excess Inventory Management