



# THE DATASHEET OF SS22SDH4



# General Specifications

Toggles

Rockers

Pushbuttons

Illuminated PB

Programmable

Keylocks

Rotaries

Slides

Tactiles

Tilt

Touch

Indicators

Accessories

Supplement

## Electrical Capacity (Resistive Load)

**Power Level (silver):** 0.1A @ 30V DC  
**Logic Level (gold):** 0.4VA maximum @ 28V AC/DC maximum  
 (Applicable Range 0.1mA ~ 0.1A @ 20mV ~ 28V)  
 Note: Find additional explanation of operating range in Supplement section.

## Other Ratings

**Contact Resistance:** 20 milliohms maximum for power level; 40 milliohms maximum for logic level  
**Insulation Resistance:** 100 megohms minimum @ 500V DC  
**Dielectric Strength:** 500V AC minimum 1 minute minimum  
**Mechanical Life:** 10,000 operations minimum  
**Electrical Life:** 10,000 operations minimum  
**Contact Timing:** SS12S & SS22S – Shorting (make-before-break)  
**Total Travel:** .079" (2.0mm)

## Materials & Finishes

**Actuator:** Polyamide  
**Upper Case:** Polyester for 3-On models; polyacetal for all other models  
**Lower Case:** Glass fiber reinforced polyester for 3-On models;  
 glass fiber reinforced polybutylene terephthalate (thermoplastic) for other models  
**Movable Contactor:** Phosphor bronze with silver plating (code 2) or  
 phosphor bronze with gold plating (code 4)  
**Interior Base:** Phenolic resin (thermoset)  
**Terminals:** Brass with silver plating over copper plating or brass with gold plating

## Environmental Data

**Operating Temp Range:** -15°C through +60°C (+5°F through +140°F)  
**Humidity:** 90 ~ 95% humidity for 96 hours @ 40°C (104°F)  
**Vibration:** 10 ~ 55Hz with peak-to-peak amplitude of 1.5mm traversing the frequency range & returning in 1 minute; 3 right angled directions for 2 hours  
**Shock:** 50G (490m/s<sup>2</sup>) acceleration (tested in 6 right angled directions, with 5 shocks in each direction)

## PCB Processing

**Soldering:** Wave Soldering: For non-supported through-hole, see Profile B in Supplement section.  
 For supported through-hole, 5 seconds maximum @ 250°C maximum.  
 Manual Solder: See Profile B in Supplement section.  
**Cleaning:** These devices are not process sealed. Hand clean locally using alcohol based solution.

## Standards & Certifications

The SS series devices have not been tested for UL recognition and CSA certification. These switches are designed for use in a low-voltage, low-current circuit. When used as intended in a low-voltage, low-current circuit, the results do not produce hazardous energy.

# Distinctive Characteristics

Top or side actuation permits flexible board design.

Compact dimensions and low profile allow high density mounting and close stacking of PC boards.

Crisp actuation positively indicates circuit status.

Double molded thermoset base and thermo-plastic housing prevent loosening of terminals due to high soldering temperatures.

Award-winning STC mechanism with benefits unavailable in conventional mechanisms: smoother, positive detent actuation, increased contact stability, and unparalleled logic-level reliability. (Additional STC details in Terms and Acronyms in the Supplement section.)

Insert molded terminals lock out flux, solvents, and other contaminants.

Inch or metric terminal spacing for standard PC board grid (.100" x .100" or 2.0mm x 2.0mm).

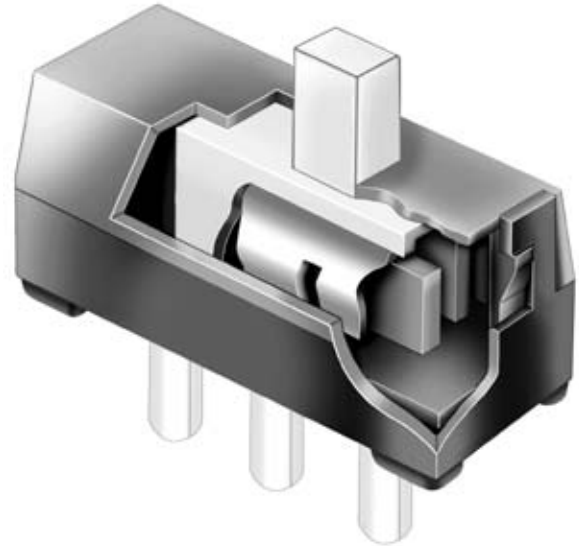

Actual Size

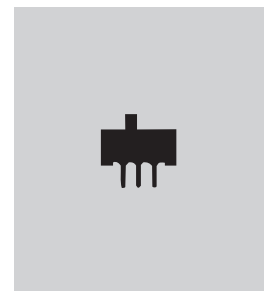

## TYPICAL SWITCH ORDERING EXAMPLE

**SS**

**12S**

**D**

**P**

**2**

### Poles & Circuits

<b>12S</b>	SPDT	ON	NONE	ON
SS12S model has shorting contacts.				
<b>* 14M</b>	SP3T	ON	ON	ON
<b>22S</b>	DPDT	ON	NONE	ON
SS22S model has shorting contacts.				
See Poles & Circuits chart below.				
* 14M Circuit with silver contacts only.				

### Terminal Spacing

<b>B</b>	Metric 2.0mm x 2.0mm
<b>D</b>	Inch .100" x .100"

### Contact Material & Ratings



<b>2</b>	Silver Rated 0.1A @ 30V DC
<b>*4</b>	Gold Rated 0.4VA maximum @ 28V AC/DC maximum
* Gold not available with SS14M.	

### Actuation



<b>P</b>	Top Actuated
<b>H</b>	Side Actuated

## DESCRIPTION FOR TYPICAL ORDERING EXAMPLE

**SS12SDP2**

Top Actuated —  — SPDT ON-NONE-ON Circuit  
 Silver Contacts Rated 0.1A @ 30V DC —  — Terminals with .100" Spacing

## POLES & CIRCUITS

		Slide Position			Connected Terminals			Throw & Schematics	
Pole	Model	Right	Center	Left	Right	Center	Left	Note: Terminal numbers are not actually on switch.	
SP	<b>SS12S</b>	ON	NONE	ON	2-1	NONE	2-3	SPDT	
SP	<b>SS14M</b>	ON	ON	ON	3-4	3-2	3-1	SP3T	 ON-OFF-ON circuit can be created by not connecting terminal 2.
DP	<b>SS22S</b>	ON	NONE	ON	2-1 5-4	NONE	2-3 5-6	DPDT	

TERMINAL SPACING

**B** Metric 2.0mm x 2.0mm with Black Base

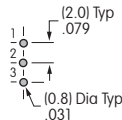
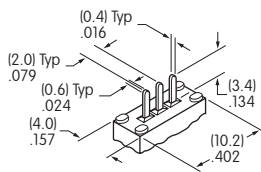

On-None-On Single Pole Models

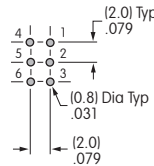
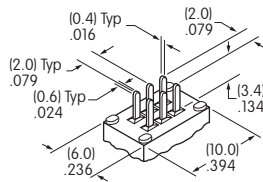

On-None-On Double Pole Models

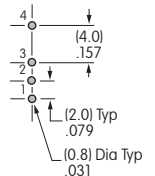
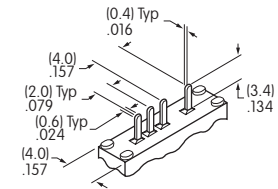

3-On Models

**D** Inch .100" x .100" with Gray Base

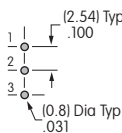
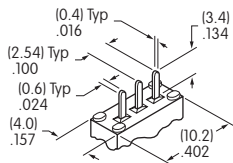

On-None-On Single Pole Models

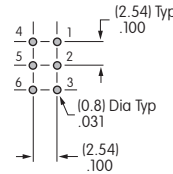
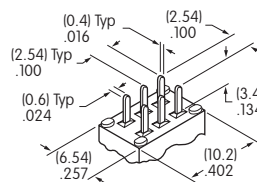

On-None-On Double Pole Models

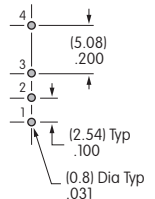
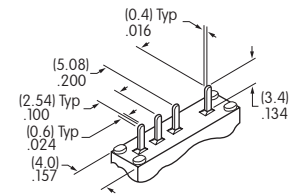

3-On Models

ACTUATION

**P** Top Actuated

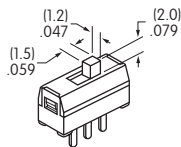

**H** Side Actuated

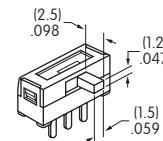

CONTACT MATERIALS & RATINGS

**2** Silver over Phosphor Bronze

Power Level

0.1A @ 30V DC

**4** Gold over Silver/Phosphor Bronze

Logic Level

0.4VA max @ 28V AC/DC max

Complete explanation of operating range in Supplement section.

## TYPICAL SWITCH DIMENSIONS

### Top Actuated

### Single & Double Pole

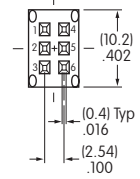
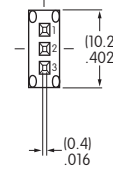
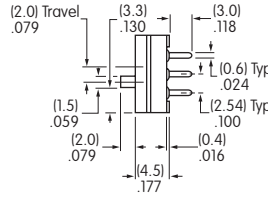
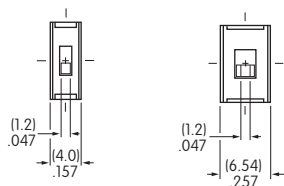

SS12SDP2

### Side Actuated

### Single & Double Pole

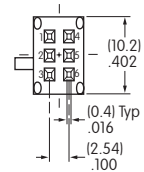
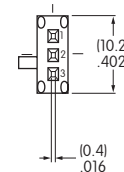
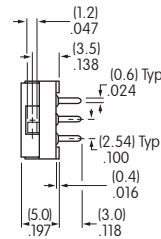
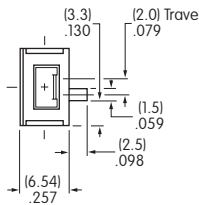
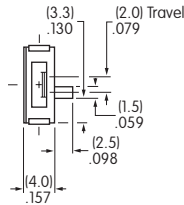

SS12SDH2

### 3-On Circuit • Top Actuated

### Single Pole

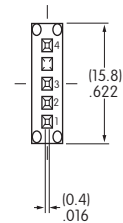
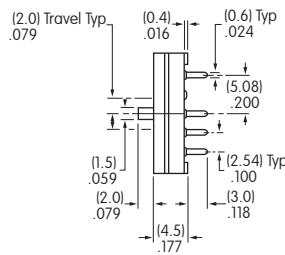
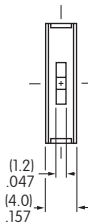

SS14MDP2

### 3-On Circuit • Side Actuated

### Single Pole

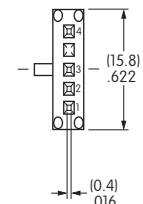
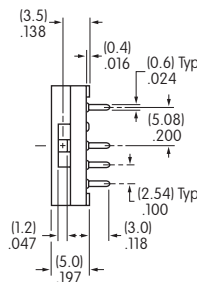
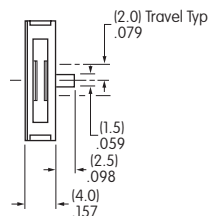

SS14MDH2

Toggle

Rockers

Pushbuttons

Illuminated PB

Programmable

Keylocks

Rotaries

Slides **H**

Tactiles

Tilt

Touch



Indicators

Accessories

Supplement

## Looking for pricing, stock, or lifecycle information?

Click below to explore more details on WIN SOURCE:

-  [View SS22SDH4 on WIN SOURCE](#)
-  [NKK Switches Information](#)

## Optimize Your Supply Chain with WIN SOURCE Solutions

-  Global Sourcing Solution
-  Obsolete Management
-  Cost Control Management
-  Shortage Management
-  Alternative Solution
-  Excess Inventory Management