



**THE DATASHEET OF
ACML-0603-060-T**



MULTILAYER FERRITE CHIP BEAD

ACML-0603



RoHS/RoHS II Compliant



1.60 x 0.80 x 0.80mm

FEATURES:

- Magnetic shielded structure designed to minimize crosstalk
- Multilayer monolithic structure yields high reliability
- Substantial EMI suppression from dozens of MHz to hundreds of MHz
- Wide range of impedance values available

APPLICATIONS:

- Noise suppression in digital equipment such as computer and its peripheral devices, DVD player, digital camera, TV and communication equipments.

STANDARD SPECIFICATIONS:

Operating temperature:	-55°C to +125°C
Storage temperature:	-10°C~+40°C and RH 70% (Max.).

Part Number ACML-0603- Impedance Code	Impedance	Frequency	DC resistance	Rated Current
Units	$\Omega \pm 25\%$	MHz	Ω max	mA max
Symbol	Z	F	R _{DC}	I _R
ACML-0603-050	0~15	100	0.10	800
ACML-0603-060	0~15	100	0.05	2000
ACML-0603-100	5~15	100	0.25	500
ACML-0603-110	0~15	100	0.05	2000
ACML-0603-220	22	100	0.20	800
ACML-0603-310	31	100	0.35	600
ACML-0603-470	47	100	0.55	300
ACML-0603-500	50	100	0.10	500
ACML-0603-600	60	100	0.30	600
ACML-0603-750	75	100	0.7	300
ACML-0603-800	80	100	0.40	600
ACML-0603-101	100	100	0.20	300
ACML-0603-121	120	100	0.40	600
ACML-0603-181	180	100	0.30	300
ACML-0603-221	220	100	0.45	500
ACML-0603-301	300	100	0.50	500
ACML-0603-331	330	100	0.50	500
ACML-0603-421	420	100	0.55	400
ACML-0603-471	470	100	0.55	400
ACML-0603-501	500	100	0.60	200
ACML-0603-601	600	100	0.60	200
ACML-0603-102	1000	100	0.80	200
ACML-0603-152	1500	100	0.80	200
ACML-0603-202	2000	100	1.00	200
ACML-0603-222	2200	100	1.00	200
ACML-0603-252	2500	100	1.20	200
ACML-0603-272	2700	100	1.4	200

Test Conditions and Equipment

IR: Rated current applied when the chip surface temperature rise just 20°C against chip surface temperature. Electric power supplier, Electric current meter, Thermometer.

Z: High Accuracy RF Impedance/Material Analyzer-E4991A or equivalent.

DCR: High Accuracy Milliohmmeter-HP4338B or equivalent.



5101 Hidden Creek Ln Spicewood TX 78669
 Phone: 512-371-6159 | Fax: 512-351-8858
 For terms and conditions of sales, please visit:
www.abracon.com

REVISED: 05-05-21

ABRACON IS
 ISO9001-2015
 CERTIFIED

MULTILAYER FERRITE CHIP BEAD

ACML-0603



RoHS/RoHS II Compliant



1.60 x 0.80 x 0.80mm

➤ PART NUMBER IDENTIFICATION

ACML-0603- -

Impedance Code
Please refer to the Electrical Specification table

Packaging
T: Tape and Reel
(4kpcs / reel)

➤ OUTLINE DIMENSION:

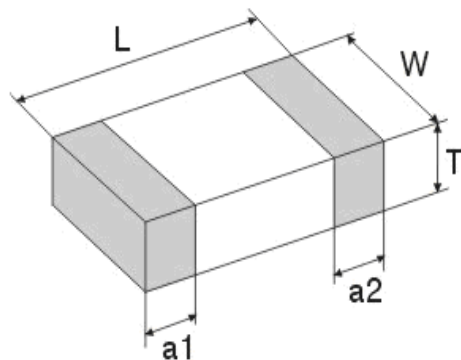

L	W	T	a1, a2
1.60±0.15	0.80±0.15	0.80±0.15	0.30±0.20

Materials

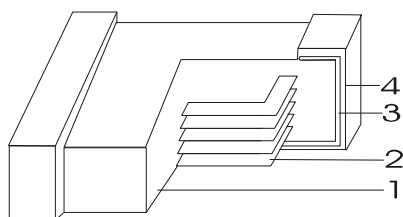

	Part Name	Material
1	Base Material	Ferrite
2	Internal Conductor	Ag
3	Terminal Electrode	Ag
4	Terminal Electrode	Ni-Sn

Dimension: mm

MULTILAYER FERRITE CHIP BEAD

ACML-0603



RoHS/RoHS II Compliant

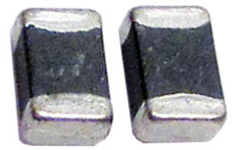

1.60 x 0.80 x 0.80mm

REFLOW PROFILE:

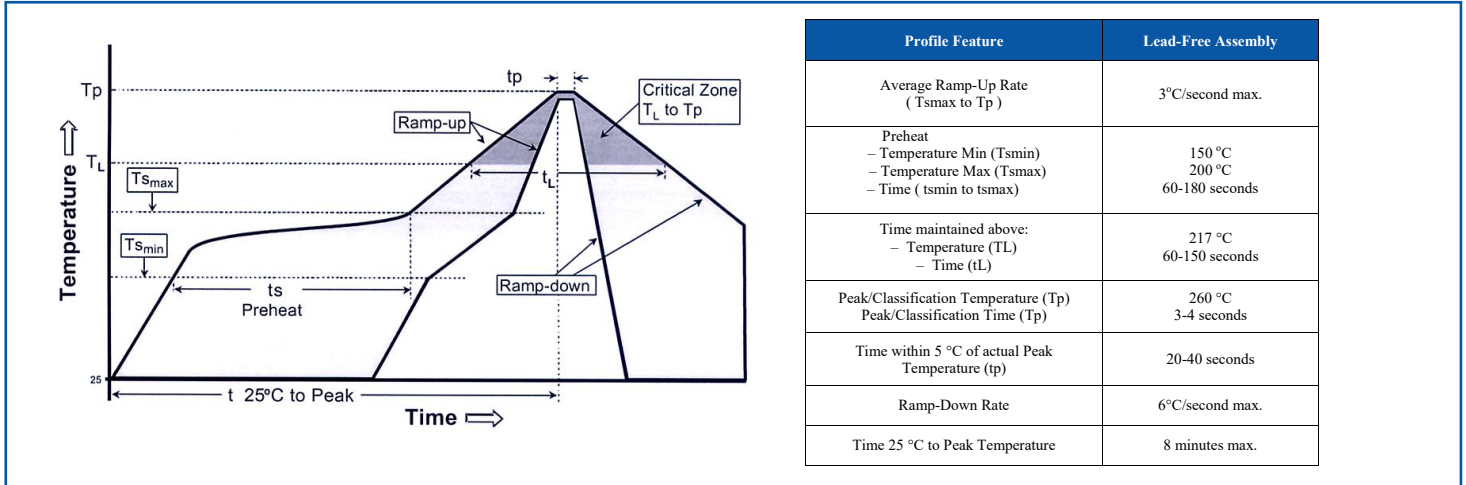

TAPE & REEL:

Packing

T= tape and reel (4,000 pcs/reel)

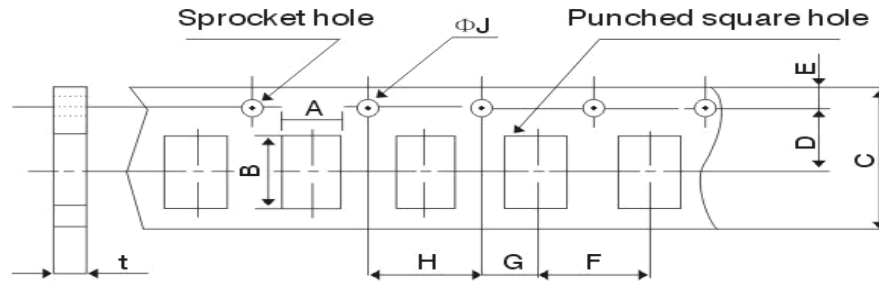

A	1.05±0.15
B	1.9±0.15
C	8.0±0.3
D	3.5±0.05
E	1.75±0.1
F	4.0±0.1
G	2.0±0.05
H	4.0±0.1
ΦJ	1.5±0.1/-0
t(max)	1.0±0.05

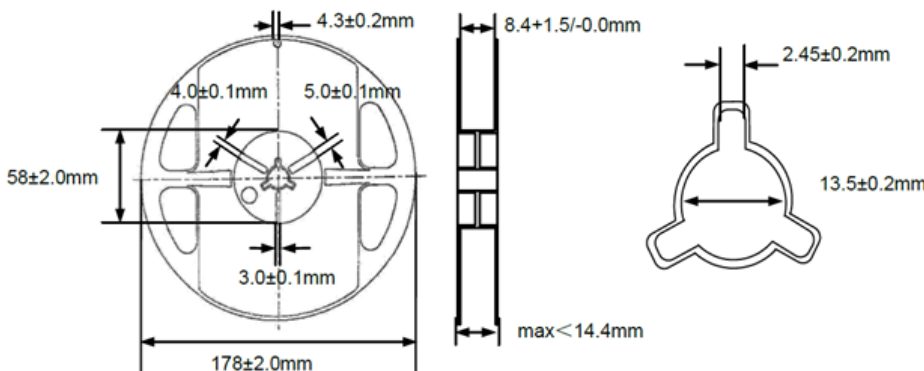

Dimension: mm

ATTENTION: Abracon LLC's products are COTS – Commercial-Off-The-Shelf products; suitable for Commercial, Industrial and, where designated, Automotive Applications. Abracon's products are not specifically designed for Military, Aviation, Aerospace, Life-dependent Medical applications or any application requiring high reliability where component failure could result in loss of life and/or property. For applications requiring high reliability and/or presenting an extreme operating environment, written consent and authorization from Abracon LLC is required. Please contact Abracon LLC for more information.





5101 Hidden Creek Ln Spicewood TX 78669
Phone: 512-371-6159 | Fax: 512-351-8858
For terms and conditions of sales, please visit:
www.abracon.com

REVISED: 05-05-21

ABRACON IS
ISO9001-2015
CERTIFIED

Looking for pricing, stock, or lifecycle information?

Click below to explore more details on WIN SOURCE:

-  [View ACML-0603-060-T on WIN SOURCE](#)
-  [Abracon LLC Information](#)

Optimize Your Supply Chain with WIN SOURCE Solutions

-  Global Sourcing Solution
-  Obsolete Management
-  Cost Control Management
-  Shortage Management
-  Alternative Solution
-  Excess Inventory Management