



**THE DATASHEET OF
ECS-8FMX-050-TR**



Not Recommended for New Designs

ECS-8FX
SMD Clock Oscillator

Request a Sample



The ECS-8FMX (5V) and ECS-8FA3X (3.3V) are CMOS compatible, J-Leaded SMD oscillators. The 8F Series utilizes a low power CMOS IC in a cost effective package suitable for reflow soldering.

OPERATING CONDITIONS / ELECTRICAL CHARACTERISTICS

ECS-8FX



- 5.0V and 3.3V Versions
- Extended Temperature Range
- RoHS Compliant
- Tape and Reel (1,000 pcs STD)

Parameters	Conditions	ECS-8FMX (+5V)			ECS-8FA3X (+3.3V)			Units
		MIN	TYP	MAX	MIN	TYP	MAX	
Frequency Range		1.000		80.000	1.000		80.000	MHz
Temperature Range	Operating	-40		+85	-40		+85	°C
	Storage	-55		+125	-55		+125	°C
Supply Voltage		+4.5	+5.0	+5.5	+3.0	+3.3	+3.6	VDC
Frequency Tolerance*	-10 ~ +70°C			±100			±100	PPM
	-40 ~ 85°C			±200			±200	PPM
Input Current	1.0 ~ 30.0 MHz			23			9	mA
	30.1 ~ 80.0 MHz			35			20	mA
Output Symmetry	@ ½ VCC Level	40/60		60/40	45/55		55/45	%
Rise and Fall Times	1.0 ~ 30.0 MHz			8			6	ns
	30.1 ~ 80.0 MHz			7			6	ns
Output Voltage	VOL			+0.5			+0.4	V
	VOH	VCC -0.5			VCC -0.4			V
Output Load	TTL			10				TTL
	CMOS			50			30	pF
Start-up Time	1.0 ~ 30.0 MHz			4			4	ms
	30.1 ~ 80.0 MHz			10			10	ms
Enable/Disable Time				100			100	ns

* Inclusive of 25°C tolerance, operating temperature range, input voltage change, load change, aging, shock, and vibration.

Part Numbering Guide: Example ECS-8FMX-500-TR

ECS	-	Series	-	Frequency Abbreviations	-	Packaging
ECS		8FMX = +5.0V 8FA3X = +3.3V		500 = 50 MHz		TR = Tape & Reel 1K/Reel

Package Dimensions (mm)

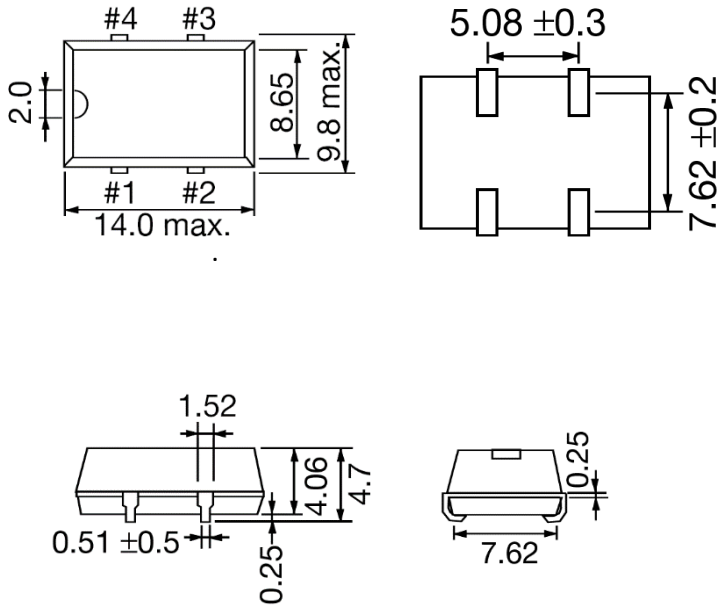

Figure 1) Top, Side, and Bottom views

Pin Connections	
#1	Tri-State
#2	Ground
#3	Output
#4	VCC

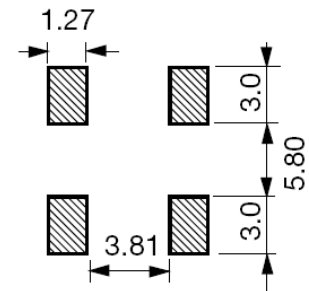

Figure 2) Land Pattern

Tri-State Control Voltage		
8FMX	8FA3X	Output
Pin 1	Pin 1	Pin 3
Open**	Open**	Oscillation
2V Min	2.4V Min	Oscillation
0.8 Max	0.6 Max	High Impedance

** An internal pullup resistor from pin 1 to 4 allows active output if pin 1 is left open.

Looking for pricing, stock, or lifecycle information?

Click below to explore more details on WIN SOURCE:

 [View ECS-8FMX-050-TR on WIN SOURCE](#)

 [ECS Inc. Information](#)

Optimize Your Supply Chain with WIN SOURCE Solutions

-  Global Sourcing Solution
-  Obsolete Management
-  Cost Control Management
-  Shortage Management
-  Alternative Solution
-  Excess Inventory Management