



**THE DATASHEET OF
CMC-2742WBL-25L**



MODEL: CMC-2742WBL-25L | **DESCRIPTION:** ELECTRET CONDENSER MICROPHONE

FEATURES

- omnidirectional
- 6.0 mm diameter
- wire leads
- IP57 rated

SPECIFICATIONS

parameter	conditions/description	min	typ	max	units
directivity	omnidirectional				
sensitivity [S]	f = 1 kHz, 1 Pa, 0 dB = 1 V/Pa	-45	-42	-39	dB
standard operating voltage [Vs]			2		Vdc
max operating voltage				10	Vdc
output impedance [Zout]	f = 1 kHz, 1 Pa		2.2		kΩ
sensitivity reduction [ΔS-Vs]	f = 1 kHz, 1 Pa, Vs = 2.0 ~ 1.5 Vdc		-3		dB
frequency [f]		100		20,000	Hz
current consumption [IDSS]	Vs = 2.0 Vdc, RL = 2.2 kΩ			0.5	mA
signal to noise ratio [S/N]	f = 1 kHz, 1 Pa, A-weighted		57		dBa
dimensions	∅6.0 x 2.7				mm
material	AL				
terminal	wire leads				
weight				0.22	g
operating temperature		-20		70	°C
storage temperature		-20		70	°C
RoHS	yes				
IP level	IP57 [IEC standard 529 edition 2.0 (1989)]				

Notes: 1. We use the "Pascal [Pa]" indication of sensitivity as per the recommendation of I.E.C. (International Electrotechnical Commission). The sensitivity of "Pa" will increase 20 dB compared to the "ubar" indication. Example: -60 dB [0 dB = 1 V/ubar] = -40 dB [1V/Pa]
 2. All specifications measured at 5-35°C, humidity at 45-85%, under 86-106 kPa pressure, unless otherwise noted.

SOLDERABILITY

parameter	conditions/description	min	typ	max	units
hand soldering	for 2 ± 0.5 seconds	310	320	330	°C

MECHANICAL DRAWING

units: mm

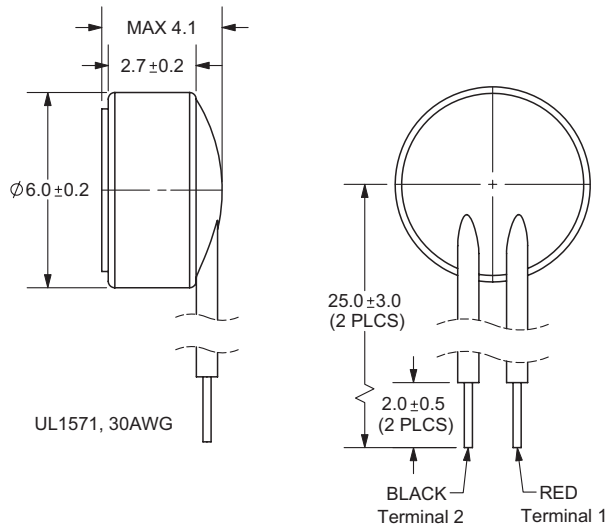

FREQUENCY RESPONSE CURVE

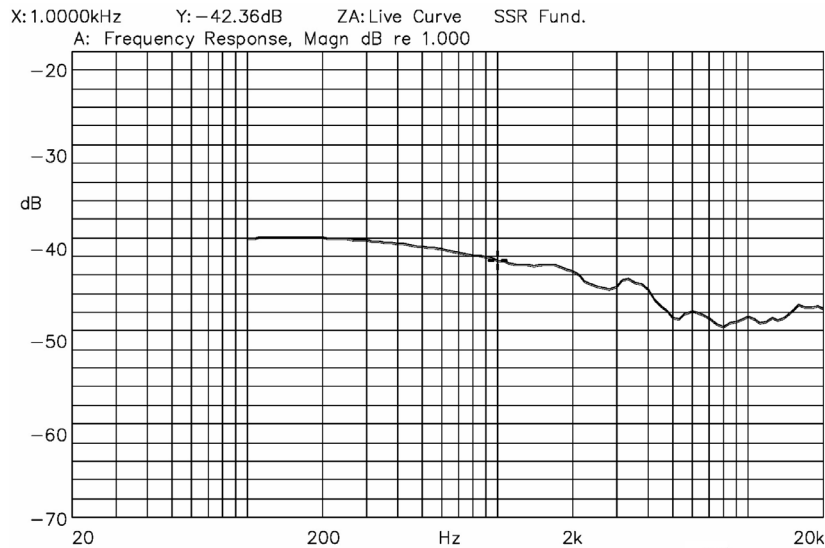

APPLICATION CIRCUIT

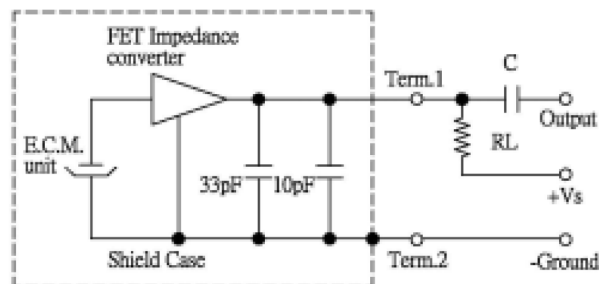

RL = 2.2 kΩ
C = 1 μF

PACKAGING

units: mm

Inner Box Size: 310 x 248 x 49 mm
Outer Box Size: 550 x 330 x 290 mm
Inner Box QTY: 1,800 pcs per box
Outer Box QTY: 18,000 pcs per box

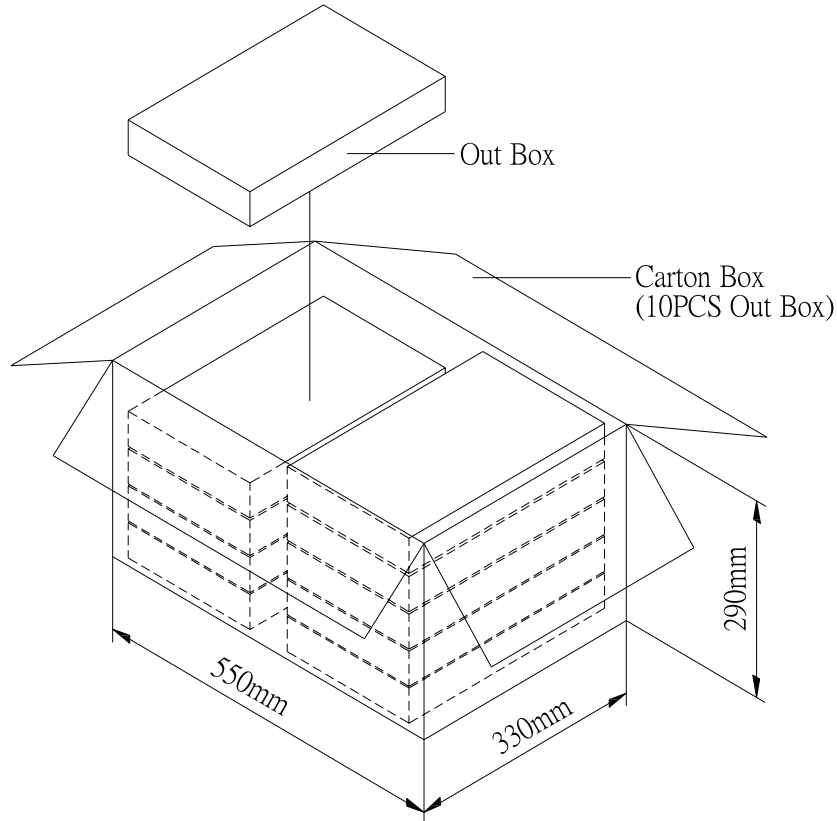
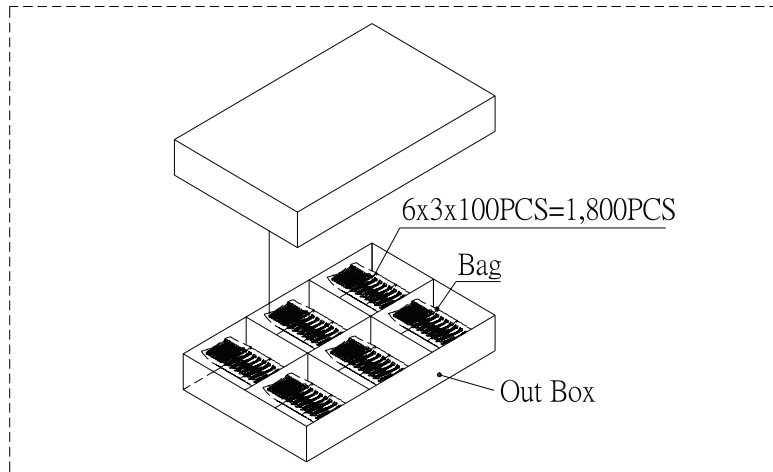

REVISION HISTORY

rev.	description	date
1.0	initial release	06/01/2008
1.01	brand update	04/24/2020
1.02	logo, datasheet style update	08/05/2022
1.03	CUI Devices rebranded to Same Sky	09/11/2024

The revision history provided is for informational purposes only and is believed to be accurate.



Same Sky offers a one (1) year limited warranty. Complete warranty information is listed on our website.



Same Sky reserves the right to make changes to the product at any time without notice. Information provided by Same Sky is believed to be accurate and reliable. However, no responsibility is assumed by Same Sky for its use, nor for any infringements of patents or other rights of third parties which may result from its use.

Same Sky products are not authorized or warranted for use as critical components in equipment that requires an extremely high level of reliability. A critical component is any component of a life support device or system whose failure to perform can be reasonably expected to cause the failure of the life support device or system, or to affect its safety or effectiveness.

[sameskydevices.com](https://www.sameskydevices.com)

Looking for pricing, stock, or lifecycle information?

Click below to explore more details on WIN SOURCE:

-  [View CMC-2742WBL-25L on WIN SOURCE](#)
-  [Same Sky Information](#)

Optimize Your Supply Chain with WIN SOURCE Solutions

-  Global Sourcing Solution
-  Obsolete Management
-  Cost Control Management
-  Shortage Management
-  Alternative Solution
-  Excess Inventory Management