



**THE DATASHEET OF  
SJ1-2515-SMT-TR**



**SERIES:** SJ1-251X-SMT | **DESCRIPTION:** AUDIO JACK**FEATURES**

- low profile design
- switch options include:
  - no switch
  - tip switch
  - tip and ring switch

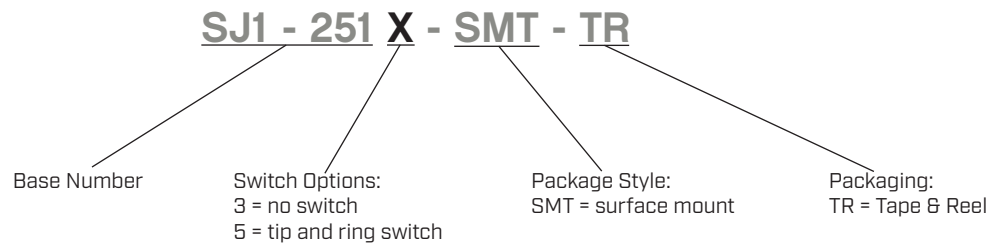
**PART NUMBER KEY****SPECIFICATIONS**

parameter	conditions/description	min	typ	max	units
rated input voltage			12		Vdc
rated input current				1	A
contact resistance				50	mΩ
insulation resistance	at 500 Vdc	100			MΩ
voltage withstand	for 1 minute			500	Vac
insertion/withdrawal force		0.3		3	kg
operating temperature		-25		85	°C
storage temperature		-40		85	°C
life			5,000		cycles
flammability rating	UL94V-0				
RoHS	yes				

## MECHANICAL DRAWING

units: mm  
 tolerance:  $\pm 0.30$  mm  
 PCB:  $\pm 0.05$  mm  
 unless otherwise specified

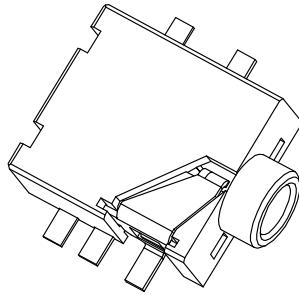

DESCRIPTION	MATERIAL	PLATING/COLOR
terminal 1	phosphor bronze t=0.30	gold
terminal 2	stainless steel t=0.20	gold
terminal 3	stainless steel t=0.20	gold
terminal 10	phosphor bronze t=0.20	gold
terminal 11	phosphor bronze t=0.20	gold
housing	PA10T (UL94V-0)	black
cover	PA10T (UL94V-0)	black

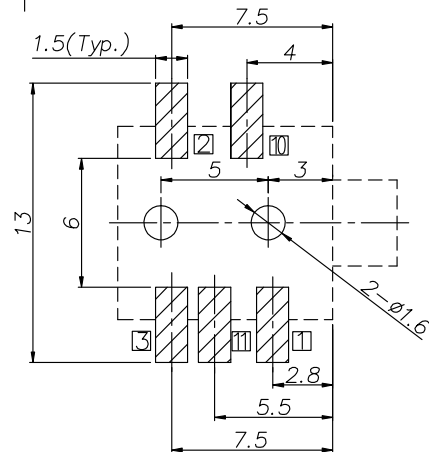
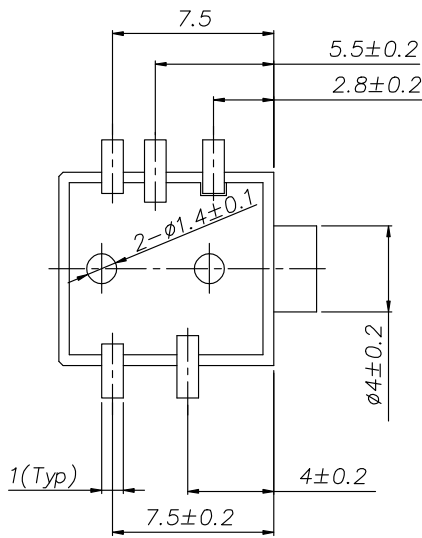
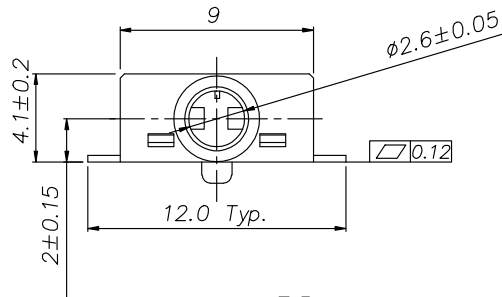
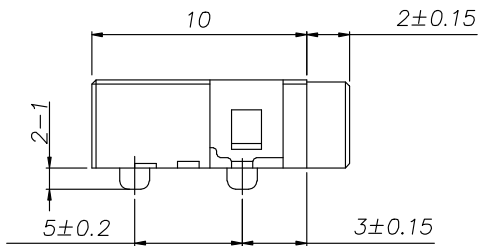

Recommended PCB Layout  
Top View

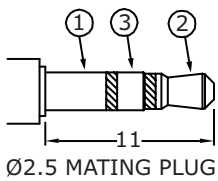

Model No.	SJ1-2513-SMT	SJ1-2515-SMT
Schematic		
PIN		
1	sleeve	sleeve
2	tip	tip
3	ring	ring
10	NP	tip switch
11	NP	ring switch

## SOLDERABILITY

parameter	conditions/description	min	typ	max	units
reel storage	5~35°C, <75% humidity				°C
reflow soldering	see reflow profile			260	°C
drying conditions	bake at 120°C for 4 hours				

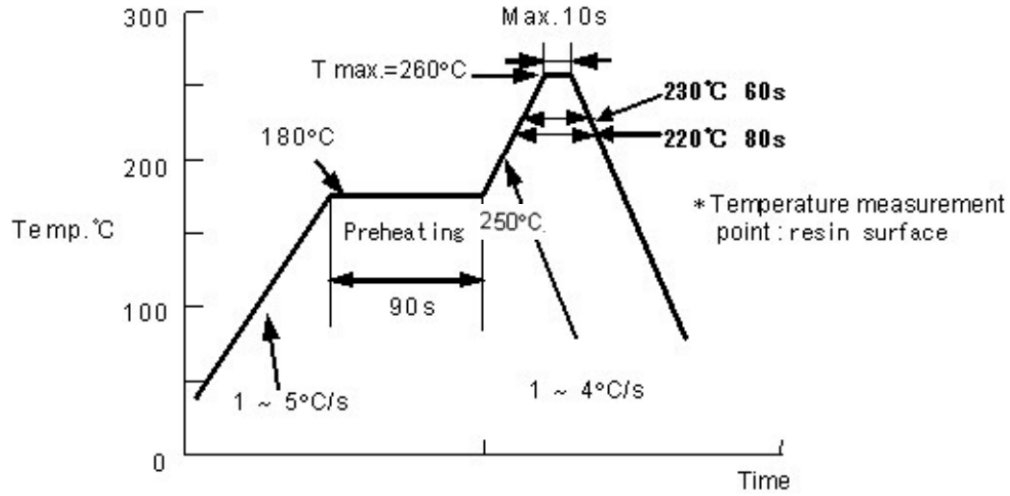

## PACKAGING

units: mm

Reel Size: Ø330 mm  
Reel QTY: 800 pcs per reel

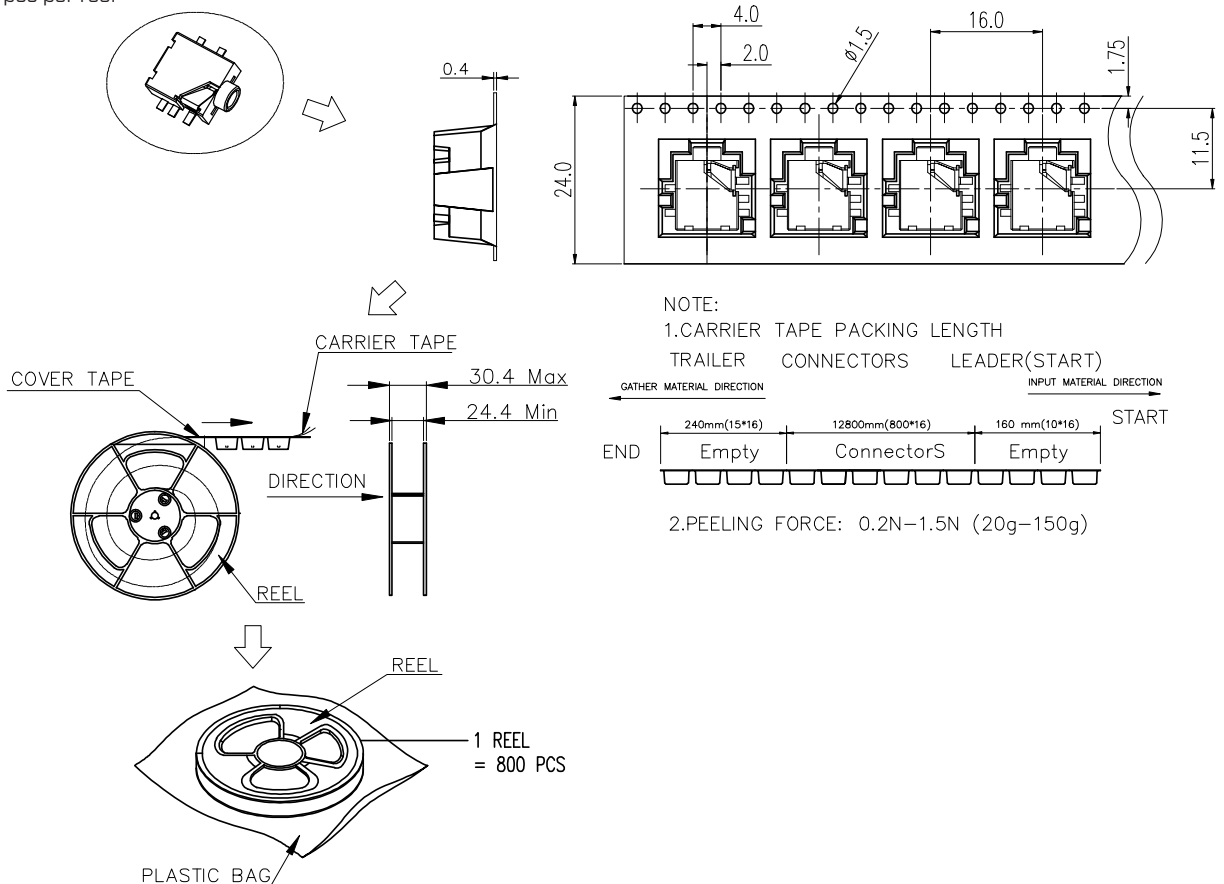

## REVISION HISTORY

rev.	description	date
1.0	initial release	02/07/2006
1.01	new template applied	01/25/2012
1.02	added TR package option	11/01/2012
1.03	added model, updated datasheet	12/07/2016
1.04	added storage and drying conditions	01/03/2018
1.05	brand update	10/04/2019
1.06	discontinued models SJ1-2514-SMT-TR & SJ1-2513C-SMT-TR; logo, datasheet style update	08/17/2022
1.07	product reengineered for improved manufacturability and production yield, see PCN for details	04/26/2023
1.08	CUI Devices rebranded to Same Sky	09/12/2024
1.09	updated drawing	01/15/2025
1.10	product reengineered for improved manufacturability and production yield, see PCN for details	12/11/2025

The revision history provided is for informational purposes only and is believed to be accurate.



Same Sky offers a one (1) year limited warranty. Complete warranty information is listed on our website.

Same Sky reserves the right to make changes to the product at any time without notice. Information provided by Same Sky is believed to be accurate and reliable. However, no responsibility is assumed by Same Sky for its use, nor for any infringements of patents or other rights of third parties which may result from its use.

Same Sky products are not authorized or warranted for use as critical components in equipment that requires an extremely high level of reliability. A critical component is any component of a life support device or system whose failure to perform can be reasonably expected to cause the failure of the life support device or system, or to affect its safety or effectiveness.

[sameskydevices.com](https://www.sameskydevices.com)

## Looking for pricing, stock, or lifecycle information?

Click below to explore more details on WIN SOURCE:

 [View SJ1-2515-SMT-TR on WIN SOURCE](#)

 [Same Sky Information](#)

## Optimize Your Supply Chain with WIN SOURCE Solutions

-  Global Sourcing Solution
-  Obsolete Management
-  Cost Control Management
-  Shortage Management
-  Alternative Solution
-  Excess Inventory Management