



**THE DATASHEET OF  
R-78AA5.0-0.5SMD**



# Features

# Switching Regulator

- Efficiency up to 95%, no need for heatsinks
- High reflow temperature SMD package
- Adjustable output voltage buck converter
- Wide input range (4.74V - 32V)
- Short circuit protection, thermal shutdown
- Remote on/off control
- Very low shutdown current
- Positive to negative converter



## R-78AA-0.5

0.5 Amp  
SMD  
Single Output



### Description

The R-78AAx-0.5SMD series are adjustable output non-isolated buck converters that meet the requirements for RoHS 10/10 as well as the reflow soldering temperatures associated with vapor phase soldering, making these high efficiency switching regulators ideally suited to modern pick-and-place mass production. The efficiency of up to 97% means that very little energy is wasted as heat. The additional features of remote on/off control, continuous short circuit protection and adjustable output voltages will find many uses in the battery-powered, industrial, medical and automotive markets.

### Selection Guide

Part Number	Input Voltage Range [VDC] <sup>(1)</sup>	Output Voltage [VDC]	Vout Adjust Range [VDC]	Output Current [A]	Efficiency @ min Vin [%]	Efficiency @ max. Vin [%]
R-78AA1.5-0.5SMD	4.75 - 30	1.5	fixed	0.5	73	63
R-78AA1.8-0.5SMD	4.75 - 32	1.8	1.5 - 3.0	0.5	82	71
R-78AA2.5-0.5SMD	4.75 - 32	2.5	1.5 - 3.0	0.5	87	77
R-78AA3.3-0.5SMD	4.75 - 32	3.3	3.0 - 5.5	0.5	91	81
R-78AA5.0-0.5SMD	6.5 - 32	5.0	3.0 - 8.0	0.5	94	86
R-78AA6.5-0.5SMD	8.0 - 32	6.5	3.3 - 11.0	0.5	95	88
R-78AA9.0-0.5SMD	11 - 32	9.0	4.5 - 12.6	0.5	96	92
R-78AA12-0.5SMD	15 - 32	12	4.5 - 12.6	0.5	97	94
R-78AA15-0.5SMD	18 - 32	15	fixed	0.5	97	95

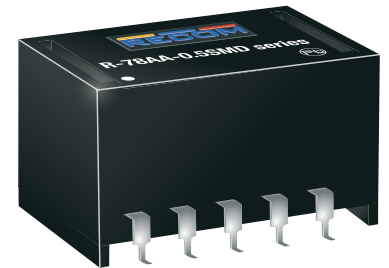

**Notes:**

Note1: Input voltage ranges valid for nominal output voltages  
Vin must be higher than Vout including adjust range and dropout voltage

EN60950-1 certified  
IEC60950-1 certified

### Model Numbering

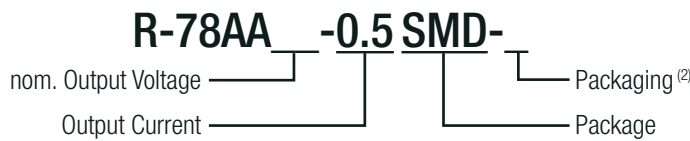

**Notes:**

Note2: add suffix -R for tape & reel packaging

**Ordering Examples:**

R-78AA5.0-0.5SMD-R = 5.0VDC Output Voltage, 0.5A, SMD, tape and reel packaging  
R-78AA2.5-0.5SMD = 2.5VDC Output Voltage, 0.5A, SMD, tube

**Specifications** (measured @ Ta= 25°C, 10% minimum load, unless otherwise stated)

**BASIC CHARACTERISTICS**

Parameter	Condition		Min.	Typ.	Max.
Absolute Maximum Input Voltage					34VDC
Quiescent Current	Vin= min. to max.			5mA	7mA
Internal Power Dissipation					0.4W
Output Voltage Adjustability			see calculation		
Minimum Load <sup>(3)</sup>			0%		
Start-up time	ON/OFF CTRL			50ms	
ON/OFF CTRL	DC-DC ON DC-DC OFF		Open or 2.8VDC < Vr < 5VDC GND or 0VDC < Vr < 0.8VDC		
Input Current of CTRL Pin	DC-DC OFF			1.8µA	
Standby Current				20µA	30µA
CTRL Thershold Voltage			2.4VDC	2.6VDC	2.8VDC
CTRL Voltage Hysteresis				250mV	
Internal Operating Frequency			280kHz	330kHz	380kHz
Output Ripple and Noise	20MHz BW	1.5VDC tp 6.5VDC 9VDC to 15VDC		20mVp-p 30mVp-p	30mVp-p 40mVp-p
Maximum Capacitive Load	with normal start-up time, no external components				470µF
	with <1 second start-up time + diode protection circuit				6800µF

**Notes:**

Note3: Operation under no load will not harm the converter, but specifications may not be met.  
A minimum load of 6mA is recommended

**Output Voltage Adjustability**  
**Adjustment Resistor Values**

V0	R1	R2	R3	Vref(V)
1.8V	10kΩ	21kΩ	5.6kΩ	1.23
2.5V	22kΩ	21kΩ	5.6kΩ	1.23
3.3V	16.9kΩ	10kΩ	5.6kΩ	1.23
5.0V	30.9kΩ	10kΩ	10kΩ	1.23
6.5V	43kΩ	10kΩ	10kΩ	1.23
9V	63.4kΩ	10kΩ	22.1kΩ	1.23
12V	88.7kΩ	10kΩ	22.1kΩ	1.23

$$R_{down} = \frac{R2(R1 + R3) \times (Vref - Vo) + Vref \times R1R3}{R2Vo - Vref (R1 + R2)}$$

$$R_{up} = \frac{R2R3 (Vref - Vo) + Vref R1 (R2 + R3)}{R2 (Vo - Vref) - Vref R1}$$

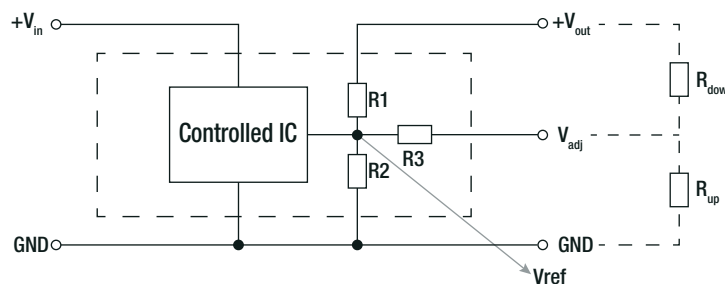

continued on next page

Specifications (measured @ Ta= 25°C, 10% minimum load, unless otherwise stated)

Efficiency vs. Vin (full load)

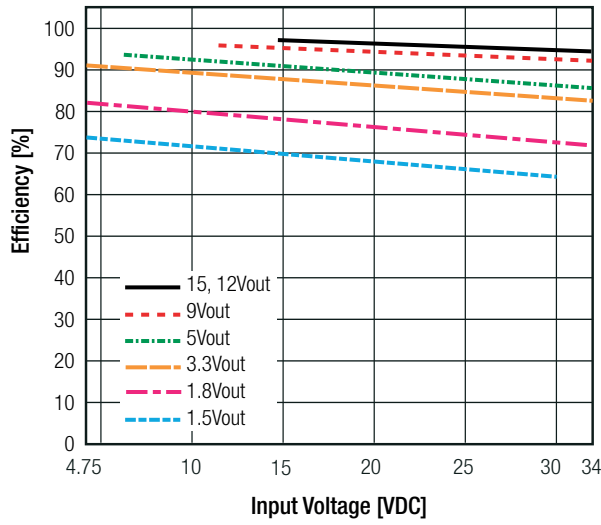

Ripple vs. Vin (full load)

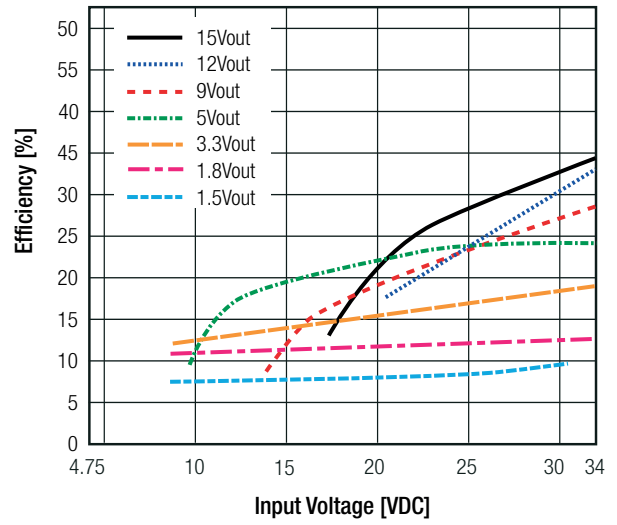

Efficiency vs. Load (max. Vin)

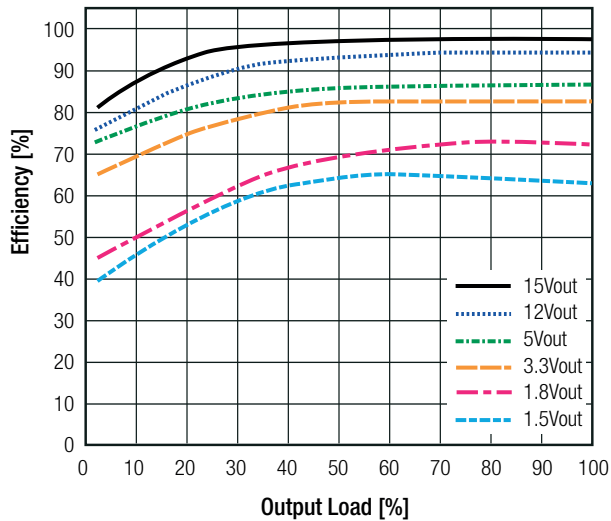

Ripple vs. Load (max. Vin)

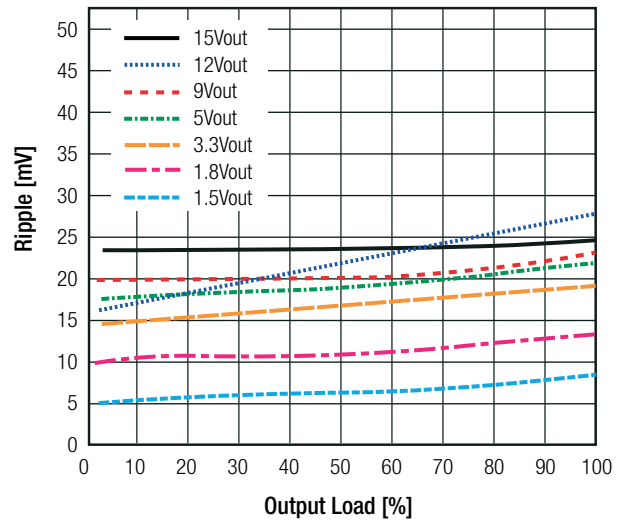

Efficiency vs. Load (min. Vin)

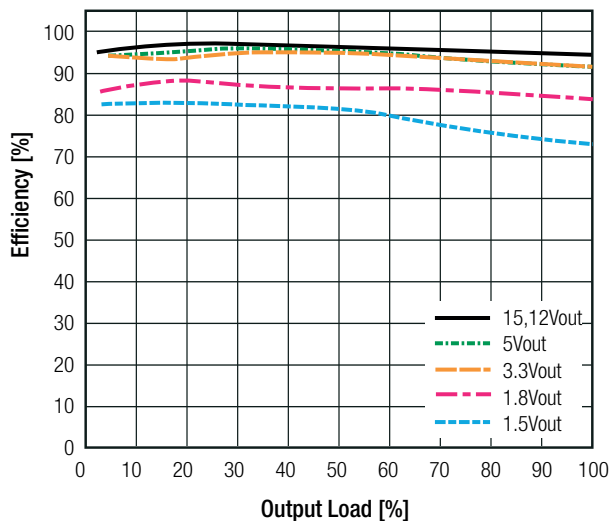

Ripple vs. Load (min. Vin)

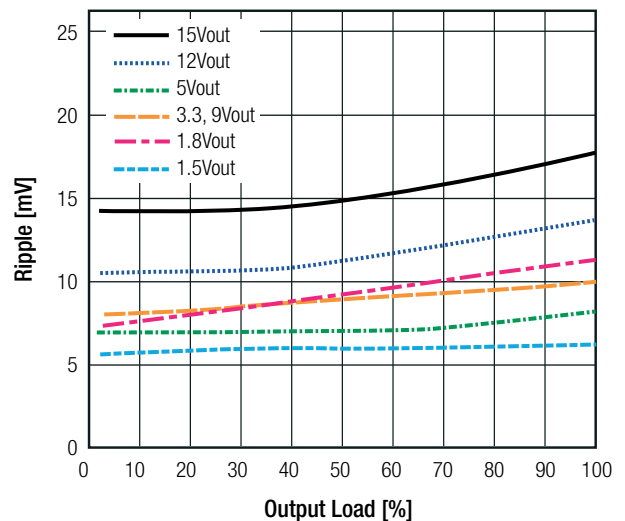

**Specifications** (measured @ Ta= 25°C, 10% minimum load, unless otherwise stated)

REGULATIONS			
Parameter	Condition		Value
Output Accuracy	full load		±2.0% typ. / ±3.0% max.
Line Regulation	low line to high line at full load	1.5 VDC tp 6.5VDC	±0.2% typ. / ±0.4% max.
		9VDC to 15VDC	±0.1% typ. / ±0.2% max.
Load Regulation	10% to 100% load	1.5 VDC tp 6.5VDC	±0.7% typ. / ±1.0% max.
		9VDC to 15VDC	±0.25% typ. / ±0.4% max.
Transient Response	with a 100µF output capacitor	100% <-> 50% load	±85mV typ. / ±100mV max.
		100% <-> 10% load	±100mV typ.

PROTECTIONS			
Parameter	Condition		Value
Short Circuit Protection (SCP)			continuous, automatic recovery
Short Circuit Input Current	nom. Vin= 24VDC		60mA typ. / 100mA max.

**Optional Diode Protection Circuit**

Add a blocking diode to Vout if current can flow backwards into the output, as this can damage the converter when it is powered down.

The diode can either be fitted across the device if the source is low impedance or fitted in series with the output (recommended).

**Optional Protection 1:**

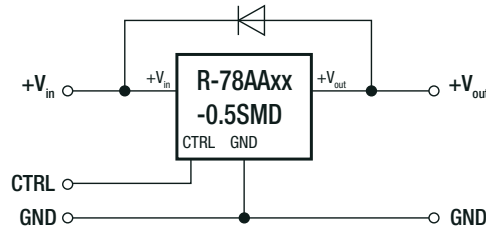

**Optional Protection 2:**

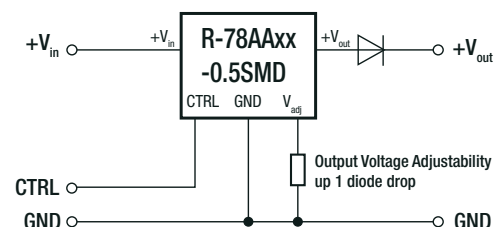

ENVIRONMENTAL			
Parameter	Condition		Value
Operating Temperature Range	with derating (see graph)		-40°C to +85°C
Maximum Case Temperature			+100°C
Temperature Coefficient			±0.015%/°C
Thermal Impedance	0.1m/s, horizontal		70°C/W
Operating Altitude			2000m
Operating Humidity	non-condensing		5% - 95% RH max.
Pollution Degree			PD2
MTBF	according to MIL-HDBK-217F, G.B.	+25°C	21098 - 29253 x 10 <sup>3</sup> hours
		+71°C	4214 - 7365 x 10 <sup>3</sup> hours

**Derating Graph**

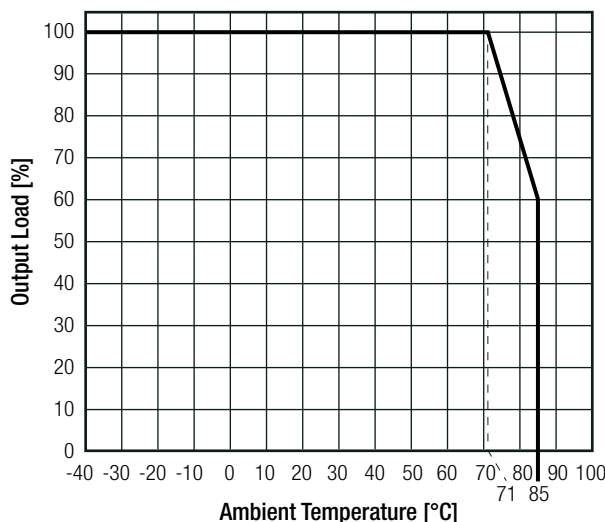

**Specifications** (measured @ Ta= 25°C, 10% minimum load, unless otherwise stated)

**SAFETY AND CERTIFICATIONS**

Certificate Type (Safety)	Report / File Number	Standard
Information Technology Equipment, General Requirements for Safety	1603123	IEC60950-1:2005, 2nd Edition + AM 2:2013 EN60950-1:2006 + AM 2:2013
EAC	RU-AT.49.09571	TP TC 004/2011
RoHS 2+		RoHS 2011/65/EU + AM2015/863

**EMC Compliance**

EMC Compliance	Condition	Standard / Criterion
Electromagnetic compatibility of multimedia equipment - Emission requirements	with external filter (see filter suggestion below)	EN55032, Class A and B
ESD Electrostatic discharge immunity test	Air ±8kV; Contact ±4kV	EN61000-4-2
Radiated, radio-frequency, electromagnetic field immunity test	3V/m	EN61000-4-3

**EMC Filter Suggestion according to EN55032**

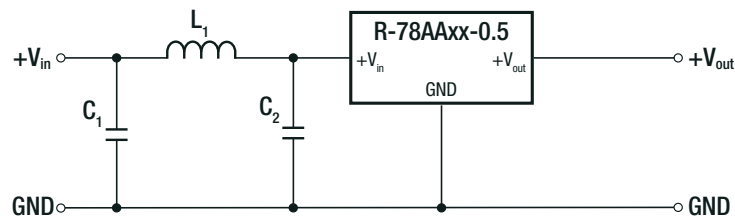

**Component List Class A**

MODEL	C1	L1
R-78AA5.0-0.5SMD	10µF 100V MLCC	3.9µH choke RLS-397
R-78AA12-0.5SMD		
R-78AA15-0.5SMD		

**Component List Class B**

MODEL	C1	C2	L1
R-78AA5.0-0.5SMD	10µF 100V MLCC	10µF 100V MLCC	5.6µH choke RLS-567
R-78AA12-0.5SMD			
R-78AA15-0.5SMD			

**Notes:**

Note4: Filter suggestions are valid for indicated part numbers only. For other part numbers, please contact RECOM tech support for advice

**DIMENSION AND PHYSICAL CHARACTERISTICS**

Parameter	Type	Value
Material	case PCB	non-conductive black plastic, (UL94 V-2) FR4, (UL94 V-1)
Dimension (LxWxH)		15.3 x 9.6 x 8.8mm
Weight		2.7g typ.

continued on next page

Specifications (measured @ Ta= 25°C, 10% minimum load, unless otherwise stated)

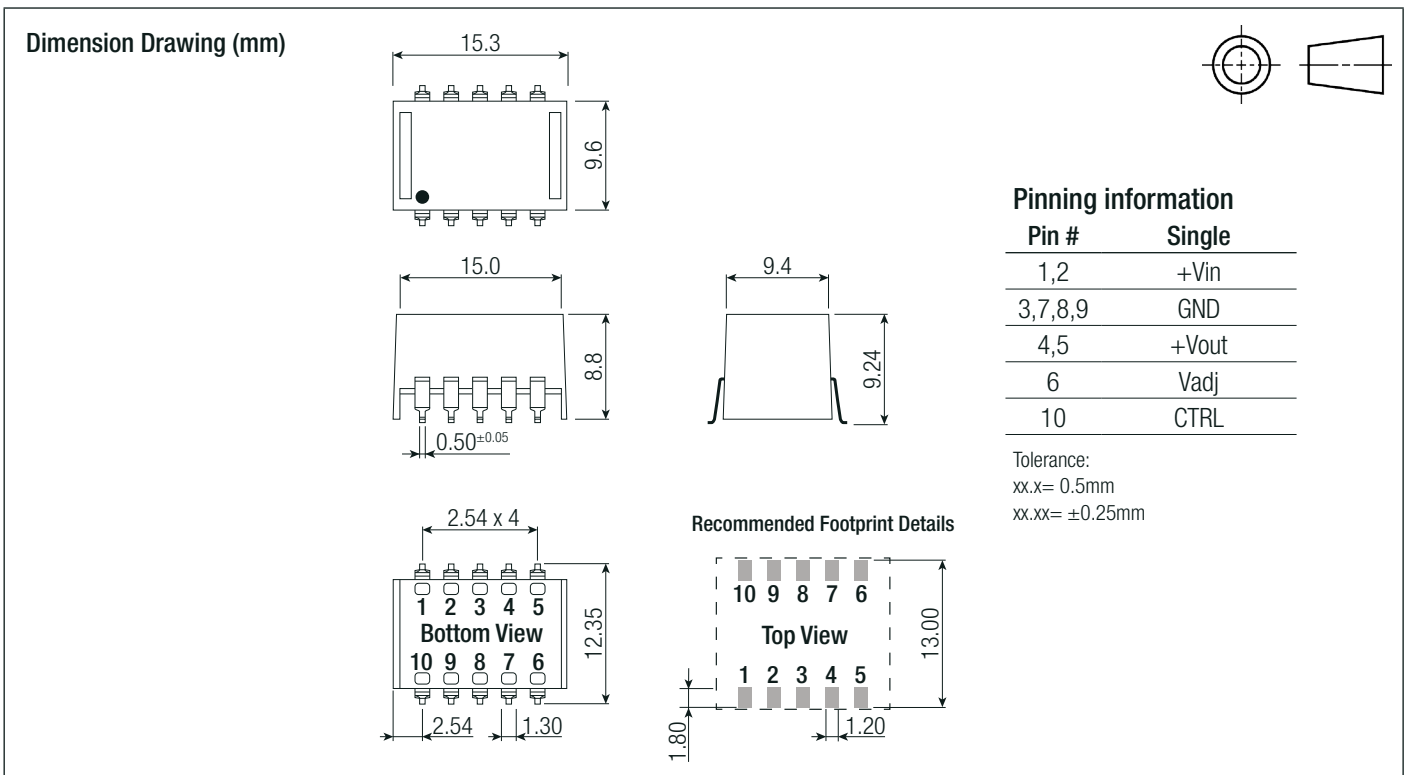

### INSTALLATION AND APPLICATION

#### Standard Application Circuit

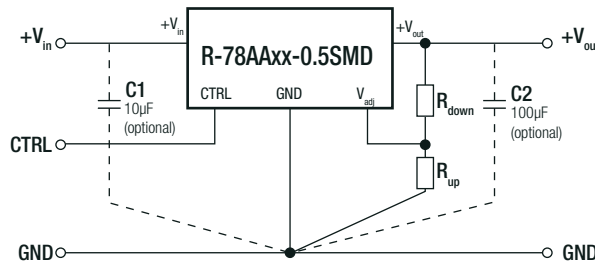

To protect the converter from high inrush currents, use soft start Vin and C1 = 10µF  
Output capacitor C2 recommended if load is very dynamic

#### Positive to Negative Converter

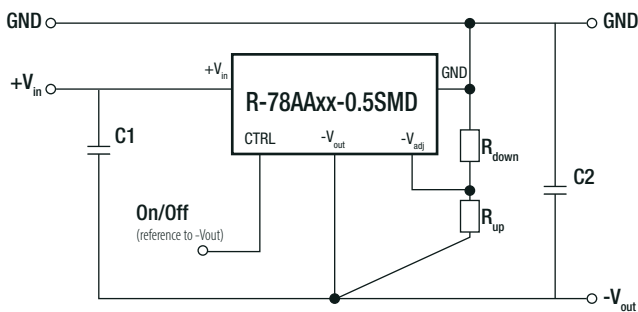

C1 and C2 are required and should be fitted close to the converter pins.

Maximum capacitiv load including C2 is 220µF

#### Pin Connections

Pin #	Negative	Positive
1,2	+Vin	+Vin
3,7,8,9	-Vout	GND
4,5	GND	+Vout
6	-Vadj	+Vadj
10	CTRL	CTRL

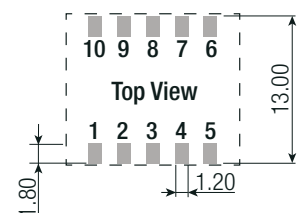

continued on next page

**Specifications** (measured @ Ta= 25°C, 10% minimum load, unless otherwise stated)

**Selection Guide - Negative Output**

Part Number	Input Voltage Range [VDC]	Output Voltage [VDC]	Output Current [A]	Efficiency		External Capacitor	
				@ min Vin [%]	@ max. Vin [%]	C1	C2 <sup>(5)</sup>
R-78AA1.5-0.5SMD	4.75 - 28	-1.5	-0.4	68	67	10µF/35V	22µF/6.3V
R-78AA1.8-0.5SMD	4.75 - 28	-1.8	-0.4	71	70	10µF/50V	22µF/6.3V
R-78AA2.5-0.5SMD	4.75 - 28	-2.5	-0.4	75	76	10µF/50V	22µF/6.3V
R-78AA3.3-0.5SMD	4.75 - 28	-3.3	-0.4	77	80	10µF/50V	22µF/6.3V
R-78AA5.0-0.5SMD	4.75 - 28	-5.0	-0.4	79	84	10µF/50V	22µF/10V
R-78AA6.5-0.5SMD	5.0 - 26	-6.5	-0.3	81	86	10µF/50V	10µF/10V
R-78AA9.0-0.5SMD	8.0 - 18	-9.0	-0.2	87	89	10µF/50V	10µF/16V
R-78AA12-0.5SMD	8.0 - 18	-12	-0.2	87	90	10µF/50V	10µF/25V
R-78AA15-0.5SMD	8.0 - 18	-15	-0.2	87	91	10µF/50V	10µF/25V

**Notes:**

Note5: Maximum Capacitive Load including C2 is 220µF



**PACKAGING INFORMATION**

Parameter	Type	Value
Packaging Dimension (LxWxH)	tube	530.0 x 17.0 x 13.0mm
	tape and reel (carton)	355.0 x 342.0 x 36.0mm
Packaging Quantity	tube	33pcs
	tape and reel	250pcs
Tape Width		24mm
Storage Temperature Range		-55°C to +125°C
Storage Humidity		95% RH max.

The product information and specifications may be subject to changes even without prior written notice. The product has been designed for various applications; its suitability lies in the responsibility of each customer. The products are not authorized for use in safety-critical applications without RECOM's explicit written consent. A safety-critical application is an application where a failure may reasonably be expected to endanger or cause loss of life, inflict bodily harm or damage property. The applicant shall indemnify and hold harmless RECOM, its affiliated companies and its representatives against any damage claims in connection with the unauthorized use of RECOM products in such safety-critical applications.

## Looking for pricing, stock, or lifecycle information?

Click below to explore more details on WIN SOURCE:

-  [View R-78AA5.0-0.5SMD on WIN SOURCE](#)
-  [Recom Power Information](#)

## Optimize Your Supply Chain with WIN SOURCE Solutions

-  Global Sourcing Solution
-  Obsolete Management
-  Cost Control Management
-  Shortage Management
-  Alternative Solution
-  Excess Inventory Management