



THE DATASHEET OF OF110JE



OD/OF Series

Little Demon® Carbon Composition Molded
10% Tolerance



FEATURES

- Molded insulation for high dielectric strength
- Rugged construction
- High surge capabilities
- Comparable to “Mil” RC07, RC20, and RC32 types
- OD/OF Series available in E12 values
- **5% Tolerance Discontinued August 2021**

Ohmite’s Little Demons are small, reliable carbon composition resistors with exceptional strength. They are made tough by a molding process that combines the terminals, insulation and resistive element into an integrated unit. Along with their small size, Little Demons perform with low noise, dissipate heat rapidly and offer high temperature stability.

Color codes are readable even after prolonged use thanks to a very durable coating that resists abrasions and chipping normally associated with automatic insertion equipment.

SERIES SPECIFICATIONS

Series	Mil-R-11 Type	Wattage	Ohms	Tolerance	Max. Voltage	Dielectric VAC
OD	RC07	0.25	2.2Ω - 5.6M	±10%	250	500
OF	RC20	0.50	2.2Ω - 18M	±10%	350	700

CHARACTERISTICS

Terminals	Solder-coated copper terminal.
Body	Molded Phenolic
Tolerance	±10%
Derating	Linearly from 100% @ +70°C to 0% @ 130°C

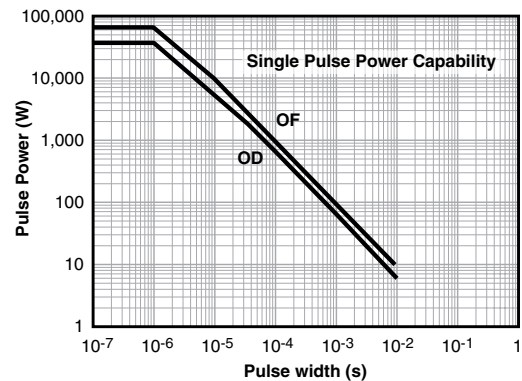

DIMENSIONS

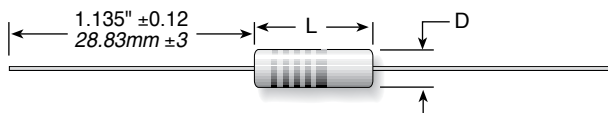

Series	Length max.	Diam. max.	Lead Dia.
OD	0.276 / 7.0	0.098 / 2.5	0.024/0.60
OF	0.406 / 10.3	0.150 / 3.8	0.028/0.70

(continued)

OD/OF Series

Little Demon® Carbon Composition Molded 10% Tolerance

PACKAGING

All resistors are packaged in sealed poly bags with desiccant to maintain a consistent humidity during storage. If parts are removed from the protective plastic bag they should be used as soon as possible or resealed in the plastic bag.

Storage: Ohmite recommends storing carbon composition resistors in a controlled environment at a temperature of 5° to 35°C and relative humidity of less than 60%. Inventory should always be used on a first-in-first-out basis.

Tape/Reel	OD	OF
Qty./reel	5000	3000
Reel size (mm)	260	260
Qty./carton	40,000	24,000
Gross carton wt. (kg)	12	13
Carton size (m ³)	0.04	0.04

Ammo Box	OD	OF
Tape width (mm)	52	52
Qty./box	2000	2000
Qty./carton	30,000	30,000
Gross carton wt. (kg)	10	16
Carton size (m ³)	0.03	0.05

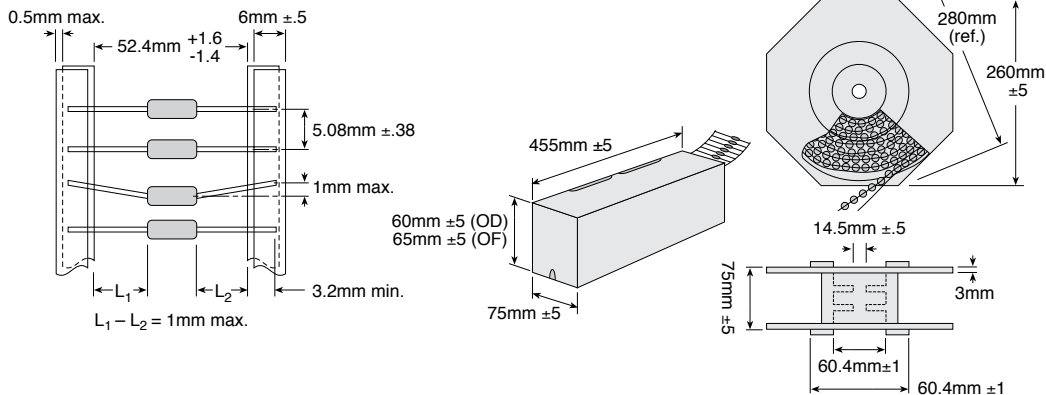

RESISTOR USE GUIDELINES

Carbon composition resistors are manufactured by extruding a blend of carbon and organic binders inside a phenolic outer body. The extrusion is cut to length, leads inserted, cured, and marked to form a finished resistor. The carbon and binder mixture is adjusted to produce different resistance values. The resistors are sorted for 10% and 20% tolerance values.

Carbon composition resistors are able to withstand larger short-term pulses and higher voltages than film resistors and are virtually impervious to ESD events (Electro-static discharge). Carbon composition resistors are also sensitive to

moisture and, therefore, storage recommendations should be adhered to. Generally, any moisture absorbed during storage will be "baked out" during the soldering operation. If the product is stored properly the resistance shift during the soldering operation will be minimal, less than 2% or 3%.

Carbon composition resistors are highly hygroscopic and changes in resistance value can occur if too much moisture is absorbed. For this reason, it is recommended not to use water or water-soluble solvents to clean these components. Alcohol or hydrocarbon solvents are recommended for rinsing.

BAKE PROCEDURE AND CAUTIONS

A. Heat Treatment

110°C ±10°C
15 hours

B. Frequency of heat treatment

1 time only

C. Solder heat test after treatment

Type	Solder Temp.	Dip Time	Evaluation
OD	300°C	3 sec	within ±3%
OF	350°C	3 sec	within ±3%

*Depth of Immersion: 4mm from the resistor body

D. Cautions

Solderability: may be affected due to oxidization of lead wire
Resistance value: some units may not completely recover to original value.

Soldering heat: some treated product may have substantial resistance change during soldering operation. It is recommended that parts be tested to evaluate soldering heat effects. Solder should not come in contact within 4mm of resistor body as this may cause a significant shift in resistance value due to high heat exposure.

ORDERING INFORMATION

RoHS compliant

OD 683 KE -TR

Series	Ohms	Tolerance	Packaging
OD	68G = 6.8	K = 10%	None = cut reel, 100/bag (std.)
OF	680 = 68		-TR = taped and reeled
	681 = 680		-A = ammo pack
	682 = 6,800		-B = bulk (loose)
	683 = 68,000		
	684 = 680,000		

Looking for pricing, stock, or lifecycle information?

Click below to explore more details on WIN SOURCE:

 [View OF110JE on WIN SOURCE](#)

 [Ohmite Information](#)

Optimize Your Supply Chain with WIN SOURCE Solutions

-  Global Sourcing Solution
-  Obsolete Management
-  Cost Control Management
-  Shortage Management
-  Alternative Solution
-  Excess Inventory Management