



**THE DATASHEET OF
ADUM4223WBRWZ**



FEATURES

4 A peak output current

Working voltage

High-side or low-side relative to input: 537 V peak

High-side to low-side differential: 800 V peak

High frequency operation: 1 MHz maximum

3.3 V to 5 V CMOS input logic

4.5 V to 18 V output drive

UVLO at 2.5 V V_{DD1}

ADuM3223A/ADuM4223A UVLO at 4.1 V V_{DD2}

ADuM3223B/ADuM4223B UVLO at 7.0 V V_{DD2}

ADuM3223C/ADuM4223C UVLO at 11.0 V V_{DD2}

Precise timing characteristics

54 ns maximum isolator and driver propagation delay

5 ns maximum channel-to-channel matching

CMOS input logic levels

High common-mode transient immunity: >25 kV/ μ s

Enhanced system-level ESD performance per IEC 61000-4-x

High junction temperature operation: 125°C

Thermal shutdown protection

Default low output

Safety and regulatory approvals

ADuM3223 narrow-body, 16-lead SOIC

UL recognition per UL 1577

3000 V rms for 1 minute SOIC long package

CSA Component Acceptance Notice 5A

VDE certificate of conformity

DIN V VDE V 0884-10 (VDE V 0884-10):2006-12

V_{IORM} = 560 V peak

ADuM4223 wide-body, 16-lead SOIC

UL recognition per UL 1577

5000 V rms for 1 minute SOIC long package

CSA Component Acceptance Notice 5A

VDE certificate of conformity

DIN V VDE V 0884-10 (VDE V 0884-10):2006-12

V_{IORM} = 849 V peak

Qualified for automotive applications

APPLICATIONS

Switching power supplies

Isolated IGBT/MOSFET gate drives

Industrial inverters

Automotive

FUNCTIONAL BLOCK DIAGRAM

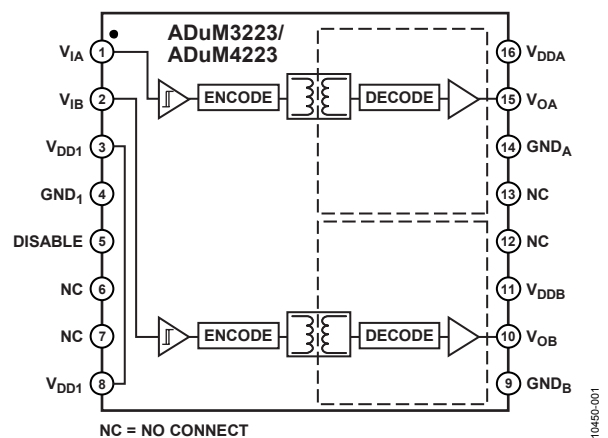

Figure 1.

GENERAL DESCRIPTION

The ADuM3223/ADuM4223¹ are 4 A isolated, half-bridge gate drivers that employ the Analog Devices, Inc., iCoupler® technology to provide independent and isolated high-side and low-side outputs. The ADuM3223 provides 3000 V rms isolation in the narrow body, 16-lead SOIC package, and the ADuM4223 provides 5000 V rms isolation in the wide body, 16-lead SOIC package. Combining high speed CMOS and monolithic transformer technology, these isolation components provide outstanding performance characteristics superior to the alternatives, such as the combination of pulse transformers and gate drivers.

The ADuM3223/ADuM4223 isolators each provide two independent isolated channels. They operate with an input supply ranging from 3.0 V to 5.5 V, providing compatibility with lower voltage systems. In comparison to gate drivers employing high voltage level translation methodologies, the ADuM3223/ADuM4223 offer the benefit of true, galvanic isolation between the input and each output. Each output may be continuously operated up to 537 V peak relative to the input, thereby supporting low-side switching to negative voltages. The differential voltage between the high-side and low-side may be as high as 800 V peak.

As a result, the ADuM3223/ADuM4223 provide reliable control over the switching characteristics of IGBT/MOSFET configurations over a wide range of positive or negative switching voltages.

¹ Protected by U.S. Patents 5,952,849; 6,873,065; 7,075,239. Other patents pending.

TABLE OF CONTENTS

Features	1	ESD Caution.....	9
Applications.....	1	Pin Configuration and Function Descriptions.....	11
Functional Block Diagram	1	Typical Performance Characteristics	12
General Description	1	Applications Information	15
Revision History	2	PC Board Layout	15
Specifications.....	3	Propagation Delay-Related Parameters.....	15
Electrical Characteristics—5 V Operation.....	3	Thermal Limitations and Switch Load Characteristics.....	15
Electrical Characteristics—3.3 V Operation	4	Output Load Characteristics.....	15
Package Characteristics	5	Boot-Strapped Half-Bridge Operation.....	16
Insulation and Safety-Related Specifications.....	5	DC Correctness and Magnetic Field Immunity.....	16
Regulatory Information.....	6	Power Consumption	17
DIN V VDE V 0884-10 (VDE V 0884-10) Insulation		Insulation Lifetime	18
Characteristics	7	Outline Dimensions	19
Recommended Operating Conditions	8	Ordering Guide	20
Absolute Maximum Ratings.....	9	Automotive Products.....	20

REVISION HISTORY

8/2017—Rev. I to Rev. J

Added V_{OA} to GND_A Negative Transient Parameter, V_{OB} to GND_B Negative Transient Parameter, and Endnote 4, Table 11

3/2017—Rev. H to Rev. I

Changes to Table 14.....

1/2017—Rev. G to Rev. H

Changes to Table 13.....

11/2015—Rev. F to Rev. G

Changes to Power Consumption Section.....

7/2015—Rev. E to Rev. F

Changes to Features Section.....

Changes to Table 6 and Table 7.....

Changes to Power Consumption Section.....

11/2014—Rev. D to Rev. E

Changes to Features Section and General Description Section.....

Changes to Table 5.....

Changes to Regulatory Information Section, Table 6, and Table 7

Changes to Table 8 and Table 9.....

4/2014—Rev. C to Rev. D

Changes to Applications Section

Changes to Insulation Lifetime Section.....

Changes to Ordering Guide

12/2013—Rev. B to Rev. C

Change to Features Section.....

Changes to Switching Specifications Parameter, Table 1

Added Thermal Shutdown Temperatures Parameter, Table 1.....

Changes to Switching Specifications Parameter, Table 2

Added Thermal Shutdown Temperatures Parameter, Table 2.....

Changes to Table 10

Change to Figure 13 Caption

Changes to Thermal Limitations and Switch Load

Characteristics Section

Change to Boot-Strapped Half-Bridge Operation Section

5/2013—Rev. A to Rev. B

Added V_{DDA} , V_{ddb} Rise Time of 0.5 V/ μ s; Table 10.....

Changes to Figure 22.....

1/2013—Rev. 0 to Rev. A

Added Automotive Information (Throughout)

Updated Safety and Regulatory Approvals (Throughout).....

Changed High-Side to Low-Side Differential from 700 $V_{DC\ PEAK}$ to 800 V peak

Added R_{OA} , R_{OB} Minimum and Maximum Values, Table 1

Added R_{OA} , R_{OB} Minimum and Maximum Values, Table 2

Changes to Table 13

Changes to Figure 19.....

Added Boot-Strapped Half Bridge Operation Section and

Figure 22; Renumbered Sequentially.....

Changes to Ordering Guide

5/2012—Revision 0: Initial Version

SPECIFICATIONS

ELECTRICAL CHARACTERISTICS—5 V OPERATION

All voltages are relative to their respective ground. $4.5\text{ V} \leq V_{DD1} \leq 5.5\text{ V}$, $4.5\text{ V} \leq V_{DD2} \leq 18\text{ V}$, unless stated otherwise. All minimum/maximum specifications apply over $T_j = -40^\circ\text{C}$ to 125°C . All typical specifications are at $T_j = 25^\circ\text{C}$, $V_{DD1} = 5\text{ V}$, $V_{DD2} = 12\text{ V}$. Switching specifications are tested with CMOS signal levels.

Table 1.

Parameter	Symbol	Min	Typ	Max	Unit	Test Conditions
DC SPECIFICATIONS						
Input Supply Current, Quiescent	$I_{DD1(Q)}$		1.4	2.4	mA	
Output Supply Current, Per Channel, Quiescent	$I_{DDO(Q)}$		2.3	3.2	mA	
Supply Current at 1 MHz						
V_{DD1} Supply Current	$I_{DD1(Q)}$		1.6	2.5	mA	Up to 1 MHz, no load
V_{DDA}/V_{DDB} Supply Current	$I_{DDA}/I_{DDB(Q)}$		5.6	8.0	mA	Up to 1 MHz, no load
Input Currents	I_{IA}, I_{IB}	-1	+0.01	+1	μA	$0 \leq V_{IA}, V_{IB} \leq V_{DD1}$
Logic High Input Threshold	V_{IH}	$0.7 \times V_{DD1}$			V	
Logic Low Input Threshold	V_{IL}			$0.3 \times V_{DD1}$	V	
Logic High Output Voltages	V_{OAH}, V_{OBH}	$V_{DD2} - 0.1$	V_{DD2}		V	$I_{Ox} = -20\text{ mA}$, $V_{Ix} = V_{IxH}$
Logic Low Output Voltages	V_{OAL}, V_{OBL}		0.0	0.15	V	$I_{Ox} = +20\text{ mA}$, $V_{Ix} = V_{IxL}$
Undervoltage Lockout, V_{DD2} Supply						
Positive Going Threshold	V_{DD2UV+}		4.1	4.4	V	A-grade
Negative Going Threshold	V_{DD2UV-}	3.2	3.6		V	A-grade
Hysteresis	V_{DD2UVH}		0.5		V	A-grade
Positive Going Threshold	V_{DD2UV+}		6.9	7.4	V	B-grade
Negative Going Threshold	V_{DD2UV-}	5.7	6.2		V	B-grade
Hysteresis	V_{DD2UVH}		0.7		V	B-grade
Positive Going Threshold	V_{DD2UV+}		10.5	11.1	V	C-grade
Negative Going Threshold	V_{DD2UV-}	8.9	9.6		V	C-grade
Hysteresis	V_{DD2UVH}		0.9		V	C-grade
Output Short-Circuit Pulsed Current ¹	$I_{OA(SC)}, I_{OB(SC)}$	2.0	4.0		A	$V_{DD2} = 12\text{ V}$
Output Pulsed Source Resistance	R_{OA}, R_{OB}	0.3	1.1	3.0	Ω	$V_{DD2} = 12\text{ V}$
Output Pulsed Sink Resistance	R_{OA}, R_{OB}	0.3	0.6	3.0	Ω	$V_{DD2} = 12\text{ V}$
THERMAL SHUTDOWN TEMPERATURES						
Junction Temperature Shutdown, Rising Edge	T_{JR}		150		$^\circ\text{C}$	
Junction Temperature Shutdown, Falling Edge	T_{JF}		140		$^\circ\text{C}$	
SWITCHING SPECIFICATIONS						
Pulse Width ²	PW	50			ns	$C_L = 2\text{ nF}$, $V_{DD2} = 12\text{ V}$
Maximum Data Rate ³		1			MHz	$C_L = 2\text{ nF}$, $V_{DD2} = 12\text{ V}$
Propagation Delay ⁴	t_{DHL}, t_{DLH}	31	43	54	ns	$C_L = 2\text{ nF}$, $V_{DD2} = 12\text{ V}$; see Figure 20
ADuM3223A/ADuM4223A	t_{DHL}, t_{DLH}	35	47	59	ns	$C_L = 2\text{ nF}$, $V_{DD2} = 4.5\text{ V}$; see Figure 20
Propagation Delay Skew ⁵	t_{PSK}			12	ns	$C_L = 2\text{ nF}$, $V_{DD2} = 12\text{ V}$; see Figure 20
Channel-to-Channel Matching ⁶	t_{PSKCD}		1	5	ns	$C_L = 2\text{ nF}$, $V_{DD2} = 12\text{ V}$; see Figure 20
	t_{PSKCD}		1	7	ns	$C_L = 2\text{ nF}$, $V_{DD2} = 4.5\text{ V}$; see Figure 20
Output Rise/Fall Time (10% to 90%)	t_R/t_F	6	12	18	ns	$C_L = 2\text{ nF}$, $V_{DD2} = 12\text{ V}$; see Figure 20
Dynamic Input Supply Current Per Channel	$I_{DDI(D)}$		0.05		mA/Mbps	$V_{DD2} = 12\text{ V}$
Dynamic Output Supply Current Per Channel	$I_{DDO(D)}$		1.65		mA/Mbps	$V_{DD2} = 12\text{ V}$
Refresh Rate	f_r		1.2		Mbps	

¹ Short-circuit duration less than 1 μs . Average power must conform to the limit shown under the Absolute Maximum Ratings.

² The minimum pulse width is the shortest pulse width at which the specified timing parameter is guaranteed.

³ The maximum data rate is the fastest data rate at which the specified timing parameter is guaranteed.

⁴ t_{DLH} propagation delay is measured from the time of the input rising logic high threshold, V_{IH} , to the output rising 10% level of the V_{Ox} signal. t_{DHL} propagation delay is measured from the input falling logic low threshold, V_{IL} , to the output falling 90% threshold of the V_{Ox} signal. See Figure 20 for waveforms of propagation delay parameters.

⁵ t_{PSK} is the magnitude of the worst-case difference in t_{DLH} and/or t_{DHL} that is measured between units at the same operating temperature, supply voltages, and output load within the recommended operating conditions. See Figure 20 for waveforms of propagation delay parameters.

⁶ Channel-to-channel matching is the absolute value of the difference in propagation delays between the two channels.

ELECTRICAL CHARACTERISTICS—3.3 V OPERATION

All voltages are relative to their respective ground. $3.0\text{ V} \leq V_{DD1} \leq 3.6\text{ V}$, $4.5\text{ V} \leq V_{DD2} \leq 18\text{ V}$, unless stated otherwise. All minimum/maximum specifications apply over $T_j = -40^\circ\text{C}$ to 125°C . All typical specifications are at $T_j = 25^\circ\text{C}$, $V_{DD1} = 3.3\text{ V}$, $V_{DD2} = 12\text{ V}$. Switching specifications are tested with CMOS signal levels.

Table 2.

Parameter	Symbol	Min	Typ	Max	Unit	Test Conditions
DC SPECIFICATIONS						
Input Supply Current, Quiescent	$I_{DD1(Q)}$		0.87	1.4	mA	
Output Supply Current, Per Channel, Quiescent	$I_{DDO(Q)}$		2.3	3.2	mA	
Supply Current at 1 MHz						
V_{DD1} Supply Current	$I_{DD1(Q)}$		1.1	1.5	mA	Up to 1 MHz, no load
V_{DDA}/V_{DDB} Supply Current	$I_{DDA}/I_{DDB(Q)}$		5.6	8.0	mA	Up to 1 MHz, no load
Input Currents	I_{IA}, I_{IB}	-10	+0.01	+10	μA	$0 \leq V_{IA}, V_{IB} \leq V_{DD1}$
Logic High Input Threshold	V_{IH}	$0.7 \times V_{DD1}$			V	
Logic Low Input Threshold	V_{IL}			$0.3 \times V_{DD1}$	V	
Logic High Output Voltages	V_{OAH}, V_{OBH}	$V_{DD2} - 0.1$	V_{DD2}		V	$I_{Ox} = -20\text{ mA}, V_{Ix} = V_{IxH}$
Logic Low Output Voltages	V_{OAL}, V_{OBL}		0.0	0.15	V	$I_{Ox} = +20\text{ mA}, V_{Ix} = V_{IxL}$
Undervoltage Lockout, V_{DD2} Supply						
Positive Going Threshold	V_{DD2UV+}		4.1	4.4	V	A-grade
Negative Going Threshold	V_{DD2UV-}	3.2	3.6		V	A-grade
Hysteresis	V_{DD2UVH}		0.5		V	A-grade
Positive Going Threshold	V_{DD2UV+}		6.9	7.4	V	B-grade
Negative Going Threshold	V_{DD2UV-}	5.7	6.2		V	B-grade
Hysteresis	V_{DD2UVH}		0.7		V	B-grade
Positive Going Threshold	V_{DD2UV+}		10.5	11.1	V	C-grade
Negative Going Threshold	V_{DD2UV-}	8.9	9.6		V	C-grade
Hysteresis	V_{DD2UVH}		0.9		V	C-grade
Output Short-Circuit Pulsed Current ¹	$I_{OA(SC)}, I_{OB(SC)}$	2.0	4.0		A	$V_{DD2} = 12\text{ V}$
Output Pulsed Source Resistance	R_{OA}, R_{OB}	0.3	1.1	3.0	Ω	$V_{DD2} = 12\text{ V}$
Output Pulsed Sink Resistance	R_{OA}, R_{OB}	0.3	0.6	3.0	Ω	$V_{DD2} = 12\text{ V}$
THERMAL SHUTDOWN TEMPERATURE						
Junction Temperature Shutdown, Rising Edge	T_{JR}		150		$^\circ\text{C}$	
Junction Temperature Shutdown, Falling Edge	T_{JF}		140		$^\circ\text{C}$	
SWITCHING SPECIFICATIONS						
Pulse Width ²	PW	50			ns	$C_L = 2\text{ nF}, V_{DD2} = 12\text{ V}$
Maximum Data Rate ³		1			MHz	$C_L = 2\text{ nF}, V_{DD2} = 12\text{ V}$
Propagation Delay ⁴	t_{DHL}, t_{DLH}	35	47	59	ns	$C_L = 2\text{ nF}, V_{DD2} = 12\text{ V}$, see Figure 20
ADuM3223A/ADuM4223A	t_{DHL}, t_{DLH}	37	51	65	ns	$C_L = 2\text{ nF}, V_{DD2} = 4.5\text{ V}$, see Figure 20
Propagation Delay Skew ⁵	t_{PSK}			12	ns	$C_L = 2\text{ nF}, V_{DD2} = 12\text{ V}$, see Figure 20
Channel-to-Channel Matching ⁶	t_{PSKCD}		1	5	ns	$C_L = 2\text{ nF}, V_{DD2} = 12\text{ V}$, see Figure 20
	t_{PSKCD}		1	7	ns	$C_L = 2\text{ nF}, V_{DD2} = 4.5\text{ V}$, see Figure 20
Output Rise/Fall Time (10% to 90%)	t_R/t_F	6	12	22	ns	$C_L = 2\text{ nF}, V_{DD2} = 12\text{ V}$, see Figure 20
Dynamic Input Supply Current Per Channel	$I_{DD1(D)}$		0.05		mA/Mbps	$V_{DD2} = 12\text{ V}$
Dynamic Output Supply Current Per Channel	$I_{DDO(D)}$		1.65		mA/Mbps	$V_{DD2} = 12\text{ V}$
Refresh Rate	f_r		1.1		Mbps	

¹ Short-circuit duration less than 1 μs . Average power must conform to the limit shown under the Absolute Maximum Ratings.

² The minimum pulse width is the shortest pulse width at which the specified timing parameter is guaranteed.

³ The maximum data rate is the fastest data rate at which the specified timing parameter is guaranteed.

⁴ t_{DLH} propagation delay is measured from the time of the input rising logic high threshold, V_{IH} , to the output rising 10% level of the V_{Ox} signal. t_{DHL} propagation delay is measured from the input falling logic low threshold, V_{IL} , to the output falling 90% threshold of the V_{Ox} signal. See Figure 20 for waveforms of propagation delay parameters.

⁵ t_{PSK} is the magnitude of the worst-case difference in t_{DLH} and/or t_{DHL} that is measured between units at the same operating temperature, supply voltages, and output load within the recommended operating conditions. See Figure 20 for waveforms of propagation delay parameters.

⁶ Channel-to-channel matching is the absolute value of the difference in propagation delays between the two channels.

PACKAGE CHARACTERISTICS

Table 3.

Parameter	Symbol	Min	Typ	Max	Unit	Test Conditions
Resistance (Input-to-Output)	R_{I-O}		10 ¹²		Ω	f = 1 MHz
Capacitance (Input-to-Output)	C_{I-O}		2.0		pF	
Input Capacitance	C_I		4.0		pF	
IC Junction-to-Ambient Thermal Resistance						
ADuM3223	θ_{JA}		76		$^{\circ}\text{C}/\text{W}$	
ADuM4223	θ_{JA}		45		$^{\circ}\text{C}/\text{W}$	
IC Junction-to-Case Thermal Resistance						
ADuM3223	θ_{JC}		42		$^{\circ}\text{C}/\text{W}$	
ADuM4223	θ_{JC}		29		$^{\circ}\text{C}/\text{W}$	

INSULATION AND SAFETY-RELATED SPECIFICATIONS

ADuM3223

Table 4.

Parameter	Symbol	Value	Unit	Conditions
Rated Dielectric Insulation Voltage		3000	V rms	1 minute duration
Minimum External Air Gap (Clearance)	L(I01)	4.0 min	mm	Measured from input terminals to output terminals, shortest distance through air
Minimum External Tracking (Creepage)	L(I02)	4.0 min	mm	Measured from input terminals to output terminals, shortest distance path along body
Minimum Internal Gap (Internal Clearance)		0.017 min	mm	Insulation distance through insulation
Tracking Resistance (Comparative Tracking Index)	CTI	>400	V	DIN IEC 112/VDE 0303 Part 1
Isolation Group		II		Material Group (DIN VDE 0110, 1/89, Table 1)

ADuM4223

Table 5.

Parameter	Symbol	Value	Unit	Conditions
Rated Dielectric Insulation Voltage		5000	V rms	1 minute duration
Minimum External Air Gap (Clearance)	L(I01)	7.6 min	mm	Measured from input terminals to output terminals, shortest distance through air
Minimum External Tracking (Creepage)	L(I02)	7.6 min	mm	Measured from input terminals to output terminals, shortest distance path along body
Minimum Internal Gap (Internal Clearance)		0.017 min	mm	Insulation distance through insulation
Tracking Resistance (Comparative Tracking Index)	CTI	>400	V	DIN IEC 112/VDE 0303 Part 1
Isolation Group		II		Material Group (DIN VDE 0110, 1/89, Table 1)

REGULATORY INFORMATION

The [ADuM3223](#) is approved or pending approval by the organizations listed in Table 6.

Table 6.

UL	CSA	VDE
Recognized under UL 1577 Component Recognition Program ¹	Approved under CSA Component Acceptance Notice 5A	Certified according to DIN V VDE V 0884-10 (VDE V 0884-10): 2006-12 ²
Single/Protection 3000 V rms Isolation Voltage	Basic insulation per CSA 60950-1-07 and IEC 60950-1, 380 V rms (537 V peak) maximum working voltage	Reinforced insulation, 560 V peak
File E214100	File 205078	File 2471900-4880-0001

¹ In accordance with UL 1577, each [ADuM3223](#) is proof tested by applying an insulation test voltage ≥ 3600 V rms for 1 second (current leakage detection limit = 6 μ A).

² In accordance with DIN V VDE V 0884-10, each [ADuM3223](#) is proof tested by applying an insulation test voltage ≥ 1050 V peak for 1 second (partial discharge detection limit = 5 pC). An asterisk (*) marking branded on the component designates DIN V VDE V 0884-10 approval.

The [ADuM4223](#) is approved or pending approval by the organizations listed in Table 7.

Table 7.

UL	CSA	CQC	VDE
Recognized Under UL 1577 Component Recognition Program ¹	Approved under CSA Component Acceptance Notice 5A	Approved under CQC11-471543-2012	Certified according to DIN V VDE V 0884-10 (VDE V 0884-10): 2006-12 ²
Single/Protection 5000 V rms Isolation Voltage	Reinforced insulation per CSA 60950-1-07 and IEC 60950-1, 380 V rms (537 V peak) maximum working voltage; basic insulation per CSA 60950-1-07 and IEC 60950-1, 760 V rms (1074 V peak) maximum working voltage	Reinforced insulation per GB4943.1-2011, 380 V rms (537 V peak) maximum working voltage, tropical climate, altitude ≤ 5000 m; basic insulation per GB4943.1-2011, 600 V rms (848 V peak) maximum working voltage, tropical climate, altitude ≤ 5000 m	Reinforced insulation, 849 V peak
File E214100	File 205078	File CQC14001108627	File 2471900-4880-0001

¹ In accordance with UL 1577, each [ADuM4223](#) is proof tested by applying an insulation test voltage ≥ 6000 V rms for 1 second (current leakage detection limit = 10 μ A).

² In accordance with DIN V VDE V 0884-10, each [ADuM4223](#) is proof tested by applying an insulation test voltage ≥ 1592 V peak for 1 second (partial discharge detection limit = 5 pC). An asterisk (*) marking branded on the component designates DIN V VDE V 0884-10 approval.

DIN V VDE V 0884-10 (VDE V 0884-10) INSULATION CHARACTERISTICS

These isolators are suitable for reinforced isolation only within the safety limit data. Maintenance of the safety data is ensured by protective circuits. The asterisk (*) marking on the package denotes DIN V VDE V 0884-10 approval for a 560 V peak working voltage.

Table 8. ADuM3223 VDE Characteristics

Description	Conditions	Symbol	Characteristic	Unit
Installation Classification per DIN VDE 0110 For Rated Mains Voltage ≤ 150 V rms For Rated Mains Voltage ≤ 300 V rms For Rated Mains Voltage ≤ 400 V rms			I to IV I to III I to II	
Climatic Classification			40/105/21	
Pollution Degree per DIN VDE 0110, Table 1			2	
Maximum Working Insulation Voltage		V_{IORM}	560	V peak
Input-to-Output Test Voltage, Method B1	$V_{IORM} \times 1.875 = V_{pd(m)}$, 100% production test, $t_{ini} = t_m = 1$ sec, partial discharge < 5 pC	$V_{pd(m)}$	1050	V peak
Input-to-Output Test Voltage, Method A	$V_{IORM} \times 1.5 = V_{pd(m)}$, $t_{ini} = 60$ sec, $t_m = 10$ sec, partial discharge < 5 pC	$V_{pd(m)}$		
After Environmental Tests Subgroup 1			896	V peak
After Input and/or Safety Test Subgroup 2 and Subgroup 3	$V_{IORM} \times 1.2 = V_{pd(m)}$, $t_{ini} = 60$ sec, $t_m = 10$ sec, partial discharge < 5 pC	$V_{pd(m)}$	672	V peak
Highest Allowable Overvoltage		V_{IOTM}	4242	V peak
Surge Isolation Voltage		V_{IOSM}	6000	V peak
Safety-Limiting Values	$V_{PEAK} = 10$ kV, 1.2 μ s rise time, 50 μ s, 50% fall time Maximum value allowed in the event of a failure (see Figure 2)			
Maximum Junction Temperature		T_S	150	$^{\circ}$ C
Safety Total Dissipated Power		P_S	1.64	W
Insulation Resistance at T_S	$V_{IO} = 500$ V	R_S	$>10^9$	Ω

Table 9. ADuM4223 VDE Characteristics

Description	Conditions	Symbol	Characteristic	Unit
Installation Classification per DIN VDE 0110 For Rated Mains Voltage ≤ 150 V rms For Rated Mains Voltage ≤ 300 V rms For Rated Mains Voltage ≤ 400 V rms			I to IV I to III I to II	
Climatic Classification			40/105/21	
Pollution Degree per DIN VDE 0110, Table 1			2	
Maximum Working Insulation Voltage		V_{IORM}	849	V peak
Input-to-Output Test Voltage, Method B1	$V_{IORM} \times 1.875 = V_{pd(m)}$, 100% production test, $t_{ini} = t_m = 1$ sec, partial discharge < 5 pC	$V_{pd(m)}$	1592	V peak
Input-to-Output Test Voltage, Method A	$V_{IORM} \times 1.5 = V_{pd(m)}$, $t_{ini} = 60$ sec, $t_m = 10$ sec, partial discharge < 5 pC	$V_{pd(m)}$		
After Environmental Tests Subgroup 1			1273	V peak
After Input and/or Safety Test Subgroup 2 and Subgroup 3	$V_{IORM} \times 1.2 = V_{pd(m)}$, $t_{ini} = 60$ sec, $t_m = 10$ sec, partial discharge < 5 pC	$V_{pd(m)}$	1018	V peak
Highest Allowable Overvoltage		V_{IOTM}	7071	V peak
Surge Isolation Voltage		V_{IOSM}	6000	V peak
Safety-Limiting Values	$V_{PEAK} = 10$ kV, 1.2 μ s rise time, 50 μ s, 50% fall time Maximum value allowed in the event of a failure (see Figure 3)			
Maximum Junction Temperature		T_S	150	$^{\circ}$ C
Safety Total Dissipated Power		P_S	2.77	W
Insulation Resistance at T_S	$V_{IO} = 500$ V	R_S	$>10^9$	Ω

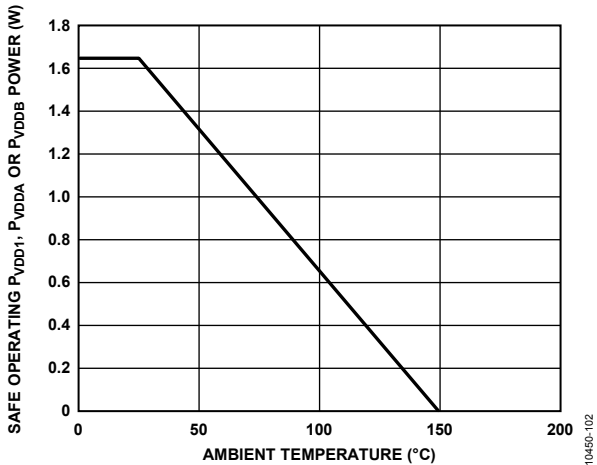

Figure 2. ADuM3223 Thermal Derating Curve, Dependence of Safety-Limiting Values on Case Temperature, per DIN V VDE V 0884-10

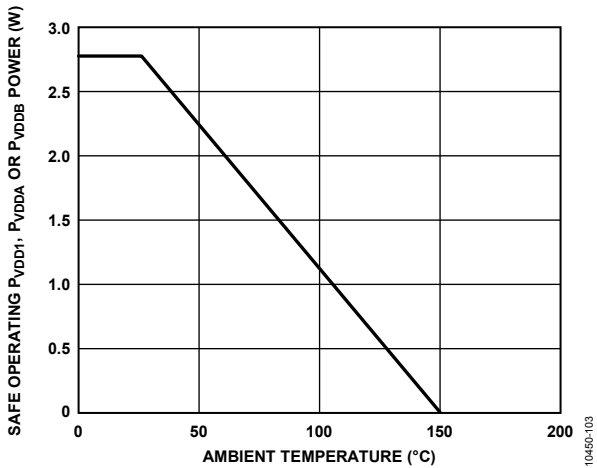

Figure 3. ADuM4223 Thermal Derating Curve, Dependence of Safety-Limiting Values on Case Temperature, per DIN V VDE V 0884-10

RECOMMENDED OPERATING CONDITIONS

Table 10.

Parameter	Symbol	Min	Max	Unit
Operating Junction Temperature	T_J	-40	+125	°C
Supply Voltages ¹				
V_{DD1}	V_{DD1}	3.0	5.5	V
V_{DDA}, V_{DDB}	V_{DDA}, V_{DDB}	4.5	18	V
V_{DD1} Rise Time	T_{VDD1}		1	V/μs
V_{DDA}, V_{DDB} Rise Time	T_{VDDA}, T_{VDDB}		10	V/μs
Maximum Input Signal Rise and Fall Times	T_{VIA}, T_{VIB}		1	ms
Common-Mode Transient Immunity, Static ²		-50	+50	kV/μs
Common-Mode Transient Immunity, Dynamic ³		-25	+25	kV/μs

¹ All voltages are relative to their respective ground. See the Applications Information section for information on immunity to external magnetic fields.
² Static common-mode transient immunity is defined as the largest dv/dt between GND₁ and GND_A/GND_B, with inputs held either high or low such that the output voltage remains either above $0.8 \times V_{DD2}$ for $V_{IA}/V_{IB} = \text{high}$ or 0.8 V for $V_{IA}/V_{IB} = \text{low}$. Operation with transients above the recommended levels may cause momentary data upsets.
³ Dynamic common-mode transient immunity is defined as the largest dv/dt between GND₁ and GND_A/GND_B, with the switching edge coincident with the transient test pulse. Operation with transients above the recommended levels may cause momentary data upsets.

ABSOLUTE MAXIMUM RATINGS

Ambient temperature = 25°C, unless otherwise noted.

Table 11.

Parameter	Symbol	Rating
Storage Temperature	T_{ST}	-55°C to +150°C
Operating Junction Temperature	T_J	-40°C to +150°C
Supply Voltages ¹	V_{DD1}	-0.5 V to +7.0 V
	V_{DDA}, V_{DDB}	-0.5 V to +20 V
Input Voltage ¹	$V_{IA}, V_{IB},$ DISABLE	-0.5 V to $V_{DD1} + 0.5 V$
Output Voltage ¹	V_{OA}	-0.5 V to $V_{DDA} + 0.5 V$
	V_{OB}	-0.5 V to $V_{DDB} + 0.5 V$
Average Output Current, per Pin ²	I_O	-35 mA to +35 mA
V_{OA} to GND_A Negative Transient ⁴	V_{OA}	-2 V for 100 ns
V_{OB} to GND_B Negative Transient ⁴	V_{OB}	-2 V for 100 ns
Common-Mode Transients ³	CM_H, CM_L	-100 kV/ μ s to +100 kV/ μ s

¹ All voltages are relative to their respective ground.

² See Figure 2 and Figure 3 for information on maximum allowable current for various temperatures.

³ Refers to common-mode transients across the insulation barrier. Common-mode transients exceeding the absolute maximum rating can cause latch-up or permanent damage.

⁴ Applies to non-automotive grade parts only.

Stresses at or above those listed under Absolute Maximum Ratings may cause permanent damage to the product. This is a stress rating only; functional operation of the product at these or any other conditions above those indicated in the operational section of this specification is not implied. Operation beyond the maximum operating conditions for extended periods may affect product reliability.

ESD CAUTION



ESD (electrostatic discharge) sensitive device. Charged devices and circuit boards can discharge without detection. Although this product features patented or proprietary protection circuitry, damage may occur on devices subjected to high energy ESD. Therefore, proper ESD precautions should be taken to avoid performance degradation or loss of functionality.

Table 12. Maximum Continuous Working Voltage¹

Parameter	Max	Unit	Constraint
AC Voltage, Bipolar Waveform	565	V peak	50-year minimum lifetime
AC Voltage, Unipolar Waveform	1131	V peak	50-year minimum lifetime
DC Voltage	1131	V peak	50-year minimum lifetime

¹ Refers to the continuous voltage magnitude imposed across the isolation barrier. See the Insulation Lifetime section for more details.

Table 13. Truth Table ADuM3223/ADuM4223 (Positive Logic)¹

DISABLE ²	V _{IA} Input	V _{IB} Input	V _{DD1} State	V _{DDA} /V _{DDB} State	V _{OA} Output	V _{OB} Output	Notes
L	L	L	Powered	Powered	L	L	
L	L	H	Powered	Powered	L	H	
L	H	L	Powered	Powered	H	L	
L	H	H	Powered	Powered	H	H	
H	X	X	Powered	Powered	L	L	
L	L	L	Unpowered	Powered	L	L	
X	X	X	Powered	Unpowered	L	L	Outputs return to the input state within 1 μs of V _{DD1} power restoration. Outputs return to the input state within 50 μs of V _{DDA} /V _{DDB} power restoration.

¹ X means don't care, L means low, and H means high.

² Reaction to DISABLE is approximately one propagation delay.

PIN CONFIGURATION AND FUNCTION DESCRIPTIONS

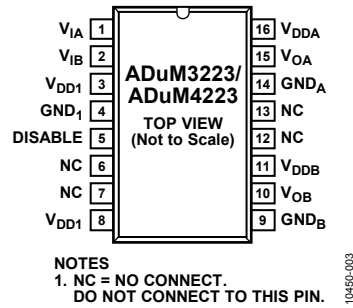

Figure 4. Pin Configuration

Table 14. ADuM3223/ADuM4223 Pin Function Descriptions

Pin No. ¹	Mnemonic	Description
1	V _{IA}	Logic Input A.
6, 7, 12, 13	NC	No Connect. Do not connect to this pin
2	V _{IB}	Logic Input B.
3, 8	V _{DD1}	Input Supply Voltage.
4	GND ₁	Ground Reference for Input Logic Signals.
5	DISABLE	Input Disable. When this pin is high, it disables the isolator inputs setting outputs to a low state. The reaction to the DISABLE pin signal is approximately equal to the normal propagation delay.
9	GND _B	Ground Reference for Output B.
10	V _{OB}	Output B.
11	V _{DDB}	Output B Supply Voltage.
14	GND _A	Ground Reference for Output A.
15	V _{OA}	Output A.
16	V _{DDA}	Output A Supply Voltage.

¹ Pin 3 and Pin 8 are internally connected; connecting both pins to supply V_{DD1} is recommended.

For specific layout guidelines, refer to the [AN-1109 Application Note, Recommendations for Control of Radiated Emissions with iCoupler Devices](#).

TYPICAL PERFORMANCE CHARACTERISTICS

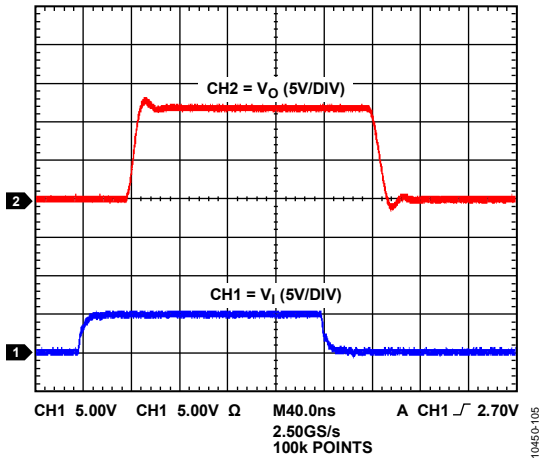

Figure 5. Output Waveform for 2 nF Load with 12 V Output Supply

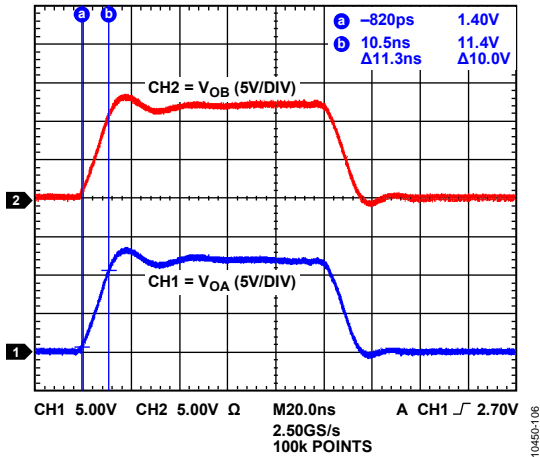

Figure 6. Output Matching and Rise Time Waveforms for 2 nF Load with 12 V Output Supply

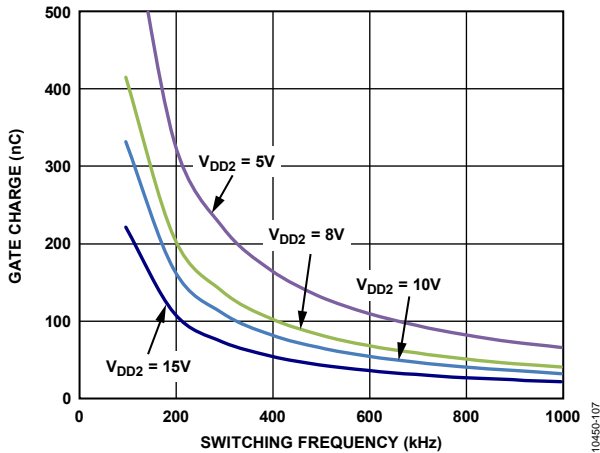

Figure 7. Typical ADuM3223 Maximum Load vs. Frequency ($R_G = 1 \Omega$)

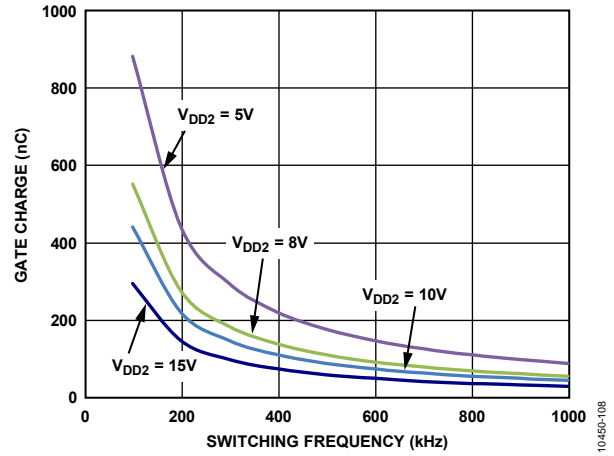

Figure 8. Typical ADuM4223 Maximum Load vs. Frequency ($R_G = 1 \Omega$)

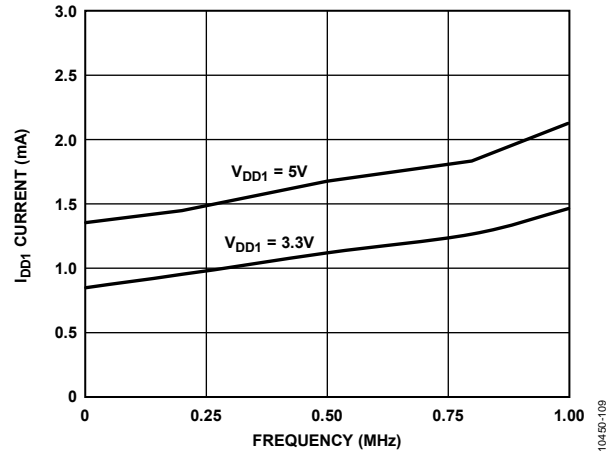

Figure 9. Typical I_{DD1} Supply Current vs. Frequency

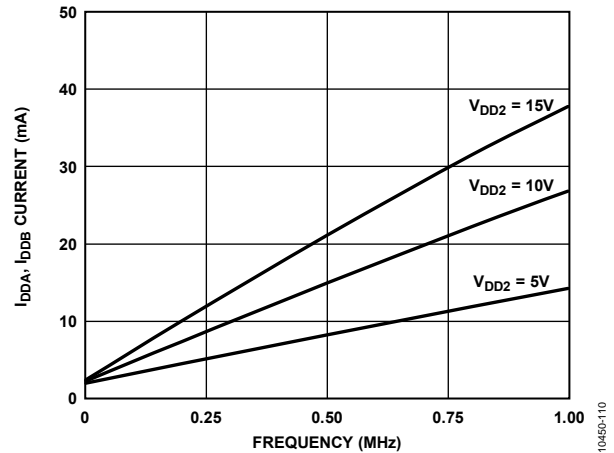

Figure 10. Typical I_{DDVA} , I_{DDBB} Supply Current vs. Frequency with 2 nF Load

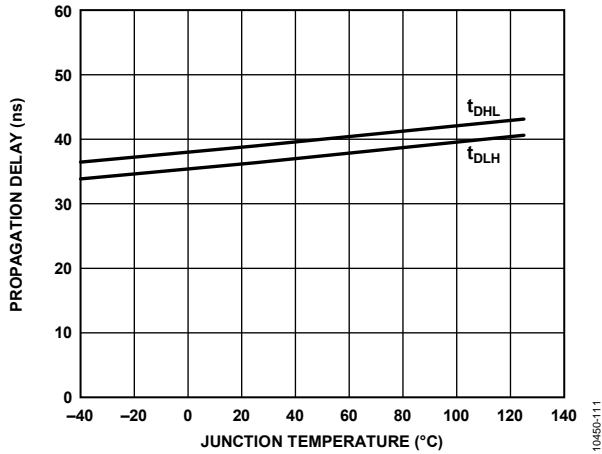

Figure 11. Typical Propagation Delay vs. Temperature

10450-111

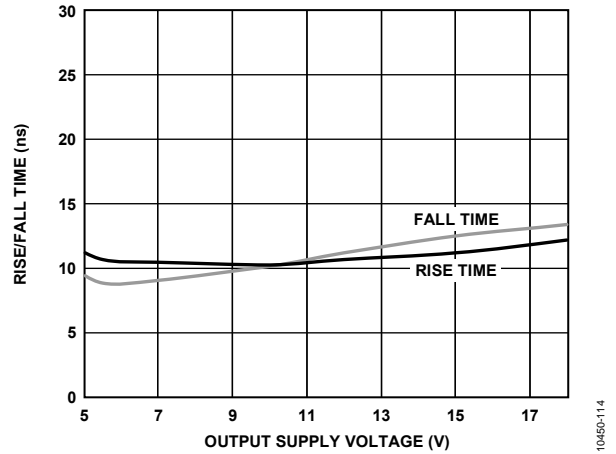

Figure 14. Typical Rise/Fall Time Variation vs. Output Supply Voltage

10450-114

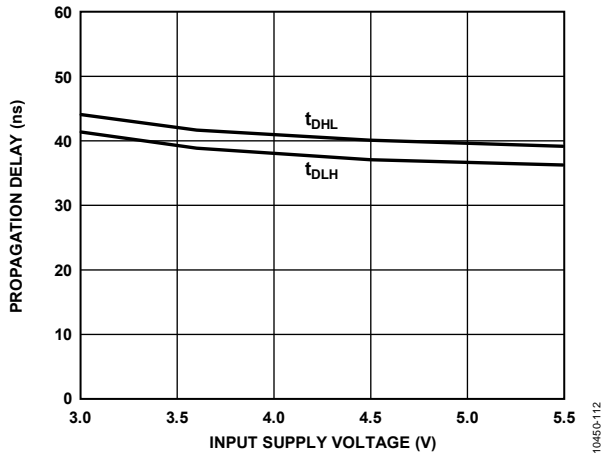

Figure 12. Typical Propagation Delay vs. Input Supply Voltage, $V_{DDA}, V_{DDB} = 12\text{ V}$

10450-112

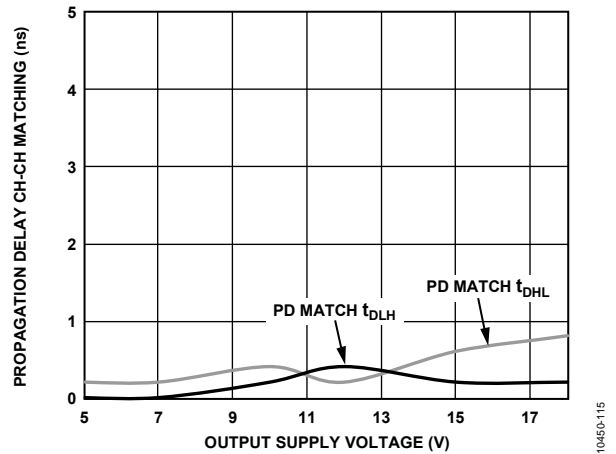

Figure 15. Typical Propagation Delay, Channel-to-Channel Matching vs. Output Supply Voltage

10450-115

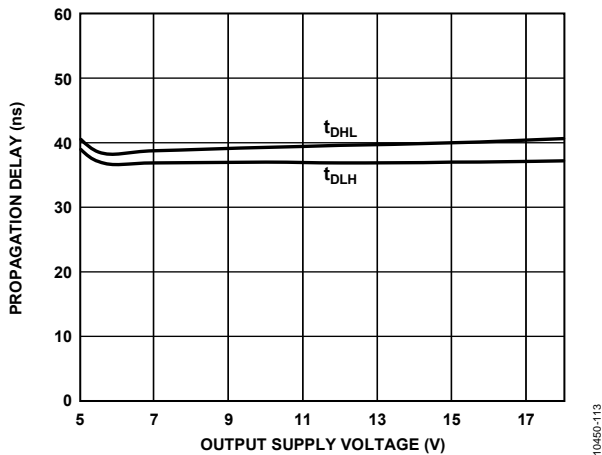

Figure 13. Typical Propagation Delay vs. Output Supply Voltage, $V_{DD1} = 5\text{ V}$

10450-113

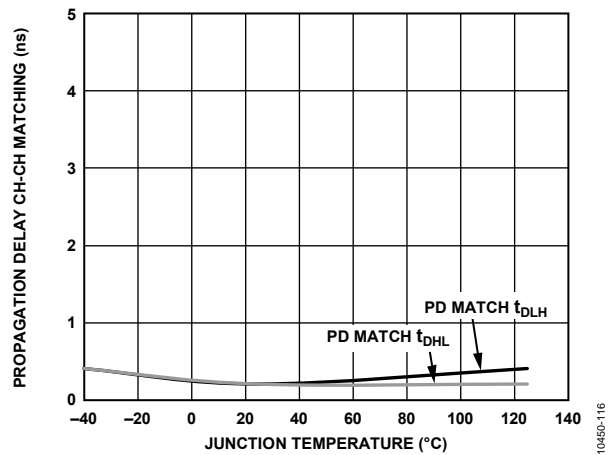

Figure 16. Typical Propagation Delay, Channel-to-Channel Matching vs. Temperature, $V_{DDA}, V_{DDB} = 12\text{ V}$

10450-116

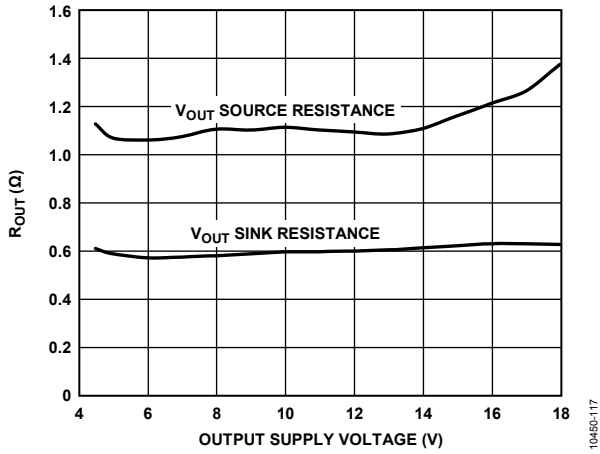

Figure 17. Typical Output Resistance vs. Output Supply Voltage

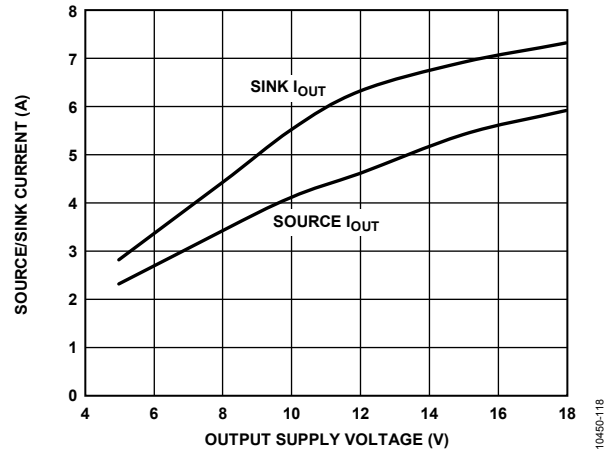

Figure 18. Typical Output Current vs. Output Supply Voltage

APPLICATIONS INFORMATION

PC BOARD LAYOUT

The ADuM3223/ADuM4223 digital isolators require no external interface circuitry for the logic interfaces. Power supply bypassing is required at the input and output supply pins, as shown in Figure 19. Use a small ceramic capacitor with a value between 0.01 μF and 0.1 μF to provide a good high frequency bypass. On the output power supply pin, V_{DDA} or V_{DDB} , it is also recommended to add a 10 μF capacitor to provide the charge required to drive the gate capacitance at the ADuM3223/ADuM4223 outputs. On the output supply pin, the bypass capacitor use of vias must be avoided or multiple vias must be employed to reduce the inductance in the bypassing. The total lead length between both ends of the smaller capacitor and the input or output power supply pin must not exceed 5 mm.

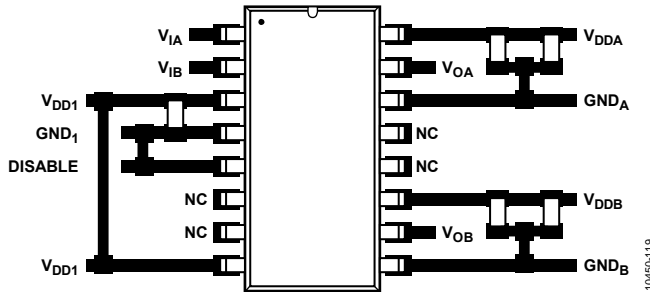

Figure 19. Recommended PCB Layout

PROPAGATION DELAY-RELATED PARAMETERS

Propagation delay is a parameter that describes the time it takes a logic signal to propagate through a component. The propagation delay to a logic low output can differ from the propagation delay to a logic high output. The ADuM3223/ADuM4223 specify t_{DLH} (see Figure 20) as the time between the rising input high logic threshold, V_{IH} , to the output rising 10% threshold. Likewise, the falling propagation delay, t_{DHL} , is defined as the time between the input falling logic low threshold, V_{IL} , and the output falling 90% threshold. The rise and fall times are dependent on the loading conditions and are not included in the propagation delay, which is the industry standard for gate drivers.

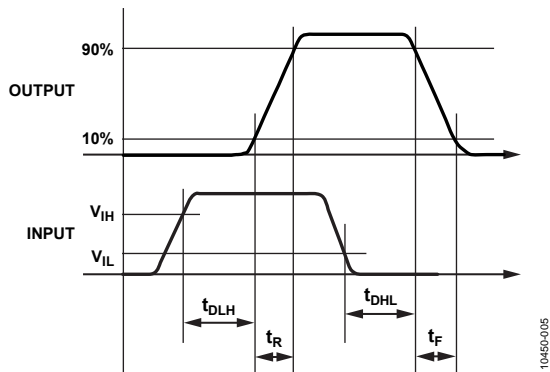

Figure 20. Propagation Delay Parameters

Channel-to-channel matching refers to the maximum amount that the propagation delay differs between channels within a single ADuM3223/ADuM4223 component.

Propagation delay skew refers to the maximum amount that the propagation delay differs between multiple ADuM3223/ADuM4223 components operating under the same conditions.

THERMAL LIMITATIONS AND SWITCH LOAD CHARACTERISTICS

For isolated gate drivers, the necessary separation between the input and output circuits prevents the use of a single thermal pad beneath the part, and heat is, therefore, dissipated mainly through the package pins.

Package thermal dissipation limits the performance of switching frequency vs. output load, as illustrated in Figure 7 and Figure 8 for the maximum load capacitance that can be driven with a 1 Ω series gate resistance for different values of output voltage. For example, this curve shows that a typical ADuM3223 can drive a large MOSFET with 140 nC gate charge at 8 V output (which is equivalent to a 17 nF load) up to a frequency of about 300 kHz.

Each of the ADuM3223/ADuM4223 isolator outputs has a thermal shutdown protection function, which sets an output to a logic low when the rising junction temperature typically reaches 150°C, and turns back on after the junction temperature falls from the shutdown by approximately 10°C.

OUTPUT LOAD CHARACTERISTICS

The ADuM3223/ADuM4223 output signals depend on the characteristics of the output load, which is typically an N-channel MOSFET. The driver output response to an N-channel MOSFET load can be modeled with a switch output resistance (R_{SW}), an inductance due to the printed circuit board trace (L_{TRACE}), a series gate resistor (R_{GATE}), and a gate-to-source capacitance (C_{GS}), as shown in Figure 21.

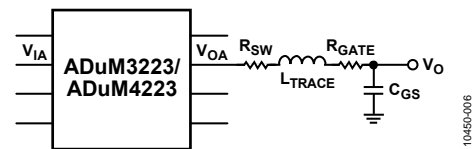

Figure 21. RLC Model of the Gate of an N-Channel MOSFET

R_{SW} is the switch resistance of the internal ADuM3223/ADuM4223 driver output, which is about 1.1 Ω . R_{GATE} is the intrinsic gate resistance of the MOSFET and any external series resistance. A MOSFET that requires a 4 A gate driver has a typical intrinsic gate resistance of about 1 Ω and a gate-to-source capacitance, C_{GS} , of between 2 nF and 10 nF. L_{TRACE} is the inductance of the printed circuit board trace, typically a value of 5 nH or less for a well-designed layout with a very short and wide connection from the ADuM3223/ADuM4223 output to the gate of the MOSFET.

Given the geometry of the receiving coil in the [ADuM3223/ADuM4223](#) and an imposed requirement that the induced voltage is, at most, 50% of the 0.5 V margin at the decoder, a maximum allowable magnetic field is calculated, as shown in Figure 23.

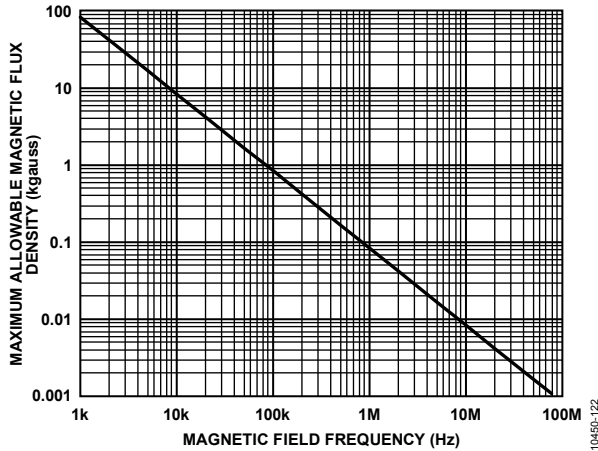

Figure 23. Maximum Allowable External Magnetic Flux Density

For example, at a magnetic field frequency of 1 MHz, the maximum allowable magnetic field of 0.08 kgauss induces a voltage of 0.25 V at the receiving coil. This is about 50% of the sensing threshold and does not cause a faulty output transition. Similarly, if such an event were to occur during a transmitted pulse (and had the worst-case polarity), the received pulse is reduced from >1.0 V to 0.75 V, still well above the 0.5 V sensing threshold of the decoder.

The preceding magnetic flux density values correspond to specific current magnitudes at given distances away from the [ADuM3223/ADuM4223](#) transformers. Figure 24 expresses these allowable current magnitudes as a function of frequency for selected distances. As shown, the [ADuM3223/ADuM4223](#) are immune and only can be affected by extremely large currents operated at a high frequency and very close to the component. For the 1 MHz example, a 0.2 kA current must be placed 5 mm away from the [ADuM3223/ADuM4223](#) to affect the component's operation.

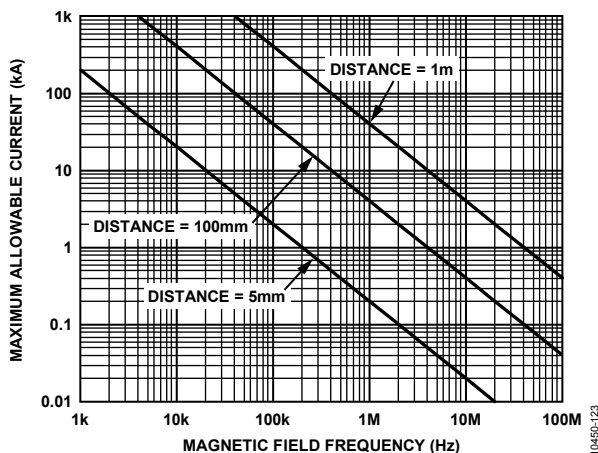

Figure 24. Maximum Allowable Current for Various Current-to-ADuM3223/ADuM4223 Spacings

POWER CONSUMPTION

The supply current at a given channel of the [ADuM3223/ADuM4223](#) isolator is a function of the supply voltage, channel data rate, and channel output load.

During the driving of a MOSFET gate, the driver must dissipate power. This power is not insignificant and can lead to thermal shutdown (TSD) if considerations are not made. The gate of a MOSFET can be simulated approximately as a capacitive load. Due to Miller capacitance and other nonlinearities, it is common practice to take the stated input capacitance, C_{ISS} , of a given MOSFET and multiply it by a factor of 5 to arrive at a conservative estimate to approximate the load being driven. With this value, the estimated total power dissipation per channel due to switching action is given by

$$P_{DISS} = C_{EST} \times (V_{DDx})^2 \times f_s$$

where:

$$C_{EST} = C_{ISS} \times 5.$$

f_s is the switching frequency.

Alternately, use the gate charge to obtain a more precise value for P_{DISS} .

$$P_{DISS} = Q_{GATE} \times V_{DDx} \times f_s$$

where:

Q_{GATE} is the gate charge for the MOSFET.

f_s is the switching frequency.

This power dissipation is shared between the internal on resistances of the internal gate driver switches and the external gate resistances, R_{GON} and R_{GOFF} . The ratio of the internal gate resistances to the total series resistance allows the calculation of losses seen within the [ADuM3223/ADuM4223](#) chips per channel.

$$P_{DISS_IC} = P_{DISS} \times \frac{1}{2} \times (R_{DS(on)_P} / (R_{EXT_X} + R_{DS(on)_P}) + R_{DS(on)_N} / (R_{EXT_X} + R_{DS(on)_N}))$$

Taking the power dissipation found inside the chip and multiplying it by θ_{JA} gives the rise above ambient temperature that the [ADuM3223/ADuM4223](#) experiences, multiplied by two to reflect that there are two channels.

$$T_J = \theta_{JA} \times 2 \times P_{DISS_IC} + T_{AMB}$$

For the device to remain within specification, T_J must not exceed 125°C. If T_J exceeds 150°C (typical), the device enters TSD.

Quiescent power dissipation may also be added to give a more accurate number for temperature rise, but the switching power losses are often the largest source of power dissipation, and quiescent losses can often be ignored. To calculate the total supply current, the quiescent supply currents for each input and output channel corresponding to $I_{DD1(Q)}$, $I_{DDA(Q)}$, and $I_{DDB(Q)}$ are added. The full equation for the T_J becomes

$$T_J = \theta_{JA} \times (2 \times P_{DISS_IC} + V_{DD1} \times I_{DD1(Q)} + V_{DDA} \times I_{DDA(Q)} + V_{DDB} \times I_{DDB(Q)}) + T_{AMB}$$

Figure 9 provides total input I_{DD1} supply current as a function of data rate for both input channels. Figure 10 provides total I_{DDA} or I_{ddb} supply current as a function of data rate for both outputs loaded with 2 nF capacitance.

INSULATION LIFETIME

All insulation structures eventually break down when subjected to voltage stress over a sufficiently long period. The rate of insulation degradation is dependent on the characteristics of the voltage waveform applied across the insulation. In addition to the testing performed by the regulatory agencies, Analog Devices carries out an extensive set of evaluations to determine the lifetime of the insulation structure within the [ADuM3223/ADuM4223](#).

Analog Devices performs accelerated life testing using voltage levels higher than the rated continuous working voltage. Acceleration factors for several operating conditions are determined. These factors allow calculation of the time to failure at the actual working voltage.

The values shown in Table 12 summarize the peak voltage for 50 years of service life for a bipolar ac operating condition, and the maximum CSA/VDE approved working voltages. In many cases, the approved working voltage is higher than 50-year service life voltage. Operation at these high working voltages can lead to shortened insulation life in some cases.

The insulation lifetime of the [ADuM3223/ADuM4223](#) depends on the voltage waveform type imposed across the isolation barrier. The *iCoupler* insulation structure degrades at different rates depending on whether the waveform is bipolar ac, unipolar ac, or dc. Figure 25, Figure 26, and Figure 27 illustrate these different isolation voltage waveforms.

A bipolar ac voltage environment is the worst case for the *iCoupler* products and is the 50-year operating lifetime that Analog Devices recommends for maximum working voltage. In the case of unipolar ac or dc voltage, the stress on the insulation is significantly lower. This allows operation at higher working voltages while still achieving a 50-year service life. Any crossinsulation voltage waveform that does not conform to Figure 26 or Figure 27 must be treated as a bipolar ac waveform, and its peak voltage must be limited to the 50-year lifetime voltage value listed in Table 12.

Note that the voltage presented in Figure 26 is shown as sinusoidal for illustration purposes only. It is meant to represent any voltage waveform varying between 0 V and some limiting value. The limiting value can be positive or negative, but the voltage cannot cross 0 V.

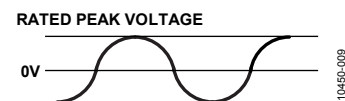

Figure 25. Bipolar AC Waveform

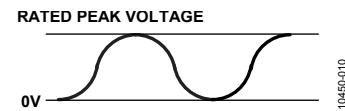

Figure 26. Unipolar AC Waveform

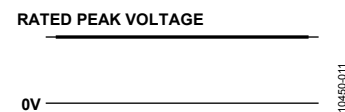
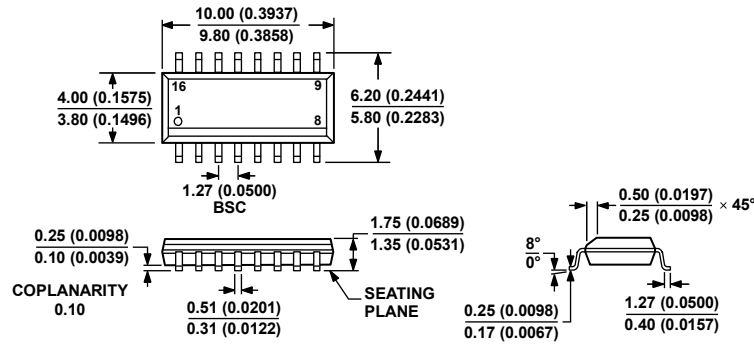

Figure 27. DC Waveform

OUTLINE DIMENSIONS



COMPLIANT TO JEDEC STANDARDS MS-012-AC
 CONTROLLING DIMENSIONS ARE IN MILLIMETERS; INCH DIMENSIONS (IN PARENTHESES) ARE ROUNDED-OFF MILLIMETER EQUIVALENTS FOR REFERENCE ONLY AND ARE NOT APPROPRIATE FOR USE IN DESIGN.

Figure 28. 16-Lead Standard Small Outline Package [SOIC_N]
 Narrow Body
 (R-16)

Dimensions shown in millimeters and (inches)

0.60606-A

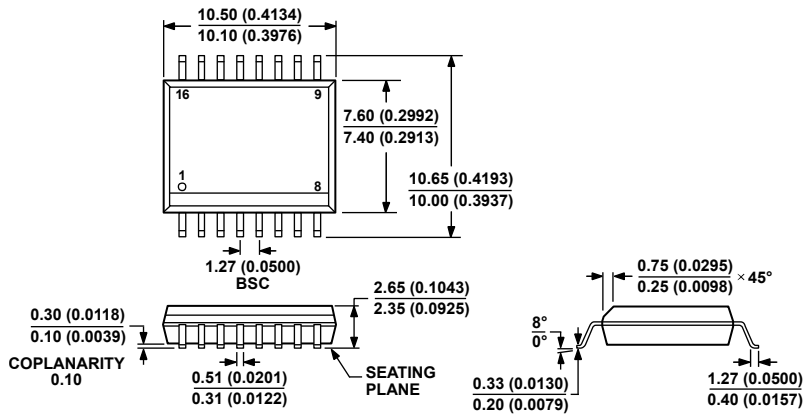

COMPLIANT TO JEDEC STANDARDS MS-013-AA
 CONTROLLING DIMENSIONS ARE IN MILLIMETERS; INCH DIMENSIONS (IN PARENTHESES) ARE ROUNDED-OFF MILLIMETER EQUIVALENTS FOR REFERENCE ONLY AND ARE NOT APPROPRIATE FOR USE IN DESIGN.

Figure 29. 16-Lead Standard Small Outline Package [SOIC_W]
 Wide Body
 (RW-16)

Dimensions shown in millimeters and (inches)

03-27-2007-B

ORDERING GUIDE

Model ^{1, 2}	No. of Channels	Output Peak Current (A)	Minimum Output Voltage (V)	Temperature Range	Package Description	Package Option	Ordering Quantity
ADuM3223ARZ	2	4	4.5	-40°C to +125°C	16-Lead SOIC_N	R-16	
ADuM3223ARZ-RL7	2	4	4.5	-40°C to +125°C	16-Lead SOIC_N, 7" Tape and Reel	R-16	1,000
ADuM3223BRZ	2	4	7.5	-40°C to +125°C	16-Lead SOIC_N	R-16	
ADuM3223BRZ-RL7	2	4	7.5	-40°C to +125°C	16-Lead SOIC_N, 7" Tape and Reel	R-16	1,000
ADuM3223CRZ	2	4	11.5	-40°C to +125°C	16-Lead SOIC_N	R-16	
ADuM3223CRZ-RL7	2	4	11.5	-40°C to +125°C	16-Lead SOIC_N, 7" Tape and Reel	R-16	1,000
ADuM3223WARZ	2	4	4.5	-40°C to +125°C	16-Lead SOIC_N	R-16	
ADuM3223WARZ-RL7	2	4	4.5	-40°C to +125°C	16-Lead SOIC_N, 7" Tape and Reel	R-16	1,000
ADuM3223WBRZ	2	4	7.5	-40°C to +125°C	16-Lead SOIC_N	R-16	
ADuM3223WBRZ-RL7	2	4	7.5	-40°C to +125°C	16-Lead SOIC_N, 7" Tape and Reel	R-16	1,000
ADuM3223WCRZ	2	4	11.5	-40°C to +125°C	16-Lead SOIC_N	R-16	
ADuM3223WCRZ-RL7	2	4	11.5	-40°C to +125°C	16-Lead SOIC_N, 7" Tape and Reel	R-16	1,000
ADuM4223ARWZ	2	4	4.5	-40°C to +125°C	16-Lead SOIC_W	RW-16	
ADuM4223ARWZ-RL	2	4	4.5	-40°C to +125°C	16-Lead SOIC_W, 13" Tape and Reel	RW-16	1,000
ADuM4223BRWZ	2	4	7.5	-40°C to +125°C	16-Lead SOIC_W	RW-16	
ADuM4223BRWZ-RL	2	4	7.5	-40°C to +125°C	16-Lead SOIC_W, 13" Tape and Reel	RW-16	1,000
ADuM4223CRWZ	2	4	11.5	-40°C to +125°C	16-Lead SOIC_W	RW-16	
ADuM4223CRWZ-RL	2	4	11.5	-40°C to +125°C	16-Lead SOIC_W, 13" Tape and Reel	RW-16	1,000
ADuM4223WARWZ	2	4	4.5	-40°C to +125°C	16-Lead SOIC_W	RW-16	
ADuM4223WARWZ-RL	2	4	4.5	-40°C to +125°C	16-Lead SOIC_W, 13" Tape and Reel	RW-16	1,000
ADuM4223WBRWZ	2	4	7.5	-40°C to +125°C	16-Lead SOIC_W	RW-16	
ADuM4223WBRWZ-RL	2	4	7.5	-40°C to +125°C	16-Lead SOIC_W, 13" Tape and Reel	RW-16	1,000
ADuM4223WCRWZ	2	4	11.5	-40°C to +125°C	16-Lead SOIC_W	RW-16	
ADuM4223WCRWZ-RL	2	4	11.5	-40°C to +125°C	16-Lead SOIC_W, 13" Tape and Reel	RW-16	1,000
EVAL-ADuM3223AEBZ	2	4	4.5	-40°C to +125°C	ADuM3223 evaluation board		
EVAL-ADuM4223AEBZ	2	4	4.5	-40°C to +125°C	ADuM4223 evaluation board		

¹ Z = RoHS Compliant Part.

² W = Qualified for Automotive Applications.

AUTOMOTIVE PRODUCTS

The [ADuM3223W](#) and [ADuM4223W](#) models are available with controlled manufacturing to support the quality and reliability requirements of automotive applications. Note that these automotive models may have specifications that differ from the commercial models; therefore, designers should review the Specifications section of this data sheet carefully. Only the automotive grade products shown are available for use in automotive applications. Contact your local Analog Devices account representative for specific product ordering information and to obtain the specific Automotive Reliability reports for these models.

Looking for pricing, stock, or lifecycle information?

Click below to explore more details on WIN SOURCE:

- ⊖ [View ADUM4223WBRWZ on WIN SOURCE](#)
- ⊖ [Analog Devices Inc. Information](#)

Optimize Your Supply Chain with WIN SOURCE Solutions

- ✓ Global Sourcing Solution
- ✓ Obsolete Management
- ✓ Cost Control Management
- ✓ Shortage Management
- ✓ Alternative Solution
- ✓ Excess Inventory Management