

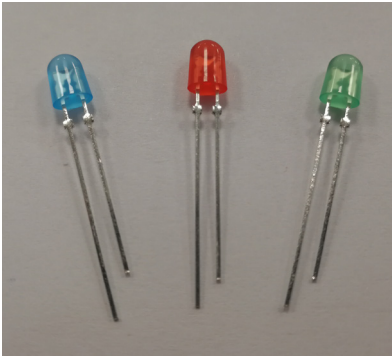

**THE DATASHEET OF
C5SMF-RJF-CT0W0BB1**



C5SMF-Rxx,Gxx,Bxx:Screen Master® 5-mm Oval LEDs



PRODUCT DESCRIPTION

These oval LEDs are specifically designed for full-color video screens, digital billboards and passenger-information signs. The oval-shaped radiation pattern and high luminous intensity ensure that these devices are excellent for bright sunlight or low power consumption outdoor applications.

These lamps are made with an advanced optical-grade epoxy that offers superior high-temperature and high-moisture-resistance performance in outdoor signal and sign applications. The encapsulation resin contains anti-UV material in order to reduce the effects of long-term exposure to direct sunlight.

FEATURES

- Size (mm): 5
- Color and Typical Dominant Wavelength:
 - Red (621nm)
 - Green(527nm)
 - Blue(470nm)
- Luminous Intensity (mcd)
 - C5SMF-RJF/RJE: (1100-4180)
 - C5SMF-GJF/GJE: (2130-8200)
 - C5SMF-BJF/BJE: (550-2130)
- Lead - Free
- RoHS Compliant

APPLICATIONS

- Electronic Signs & Signals (ESS)
- Full Color Video Screen
- Digital Billboards
- Motorway Signs
- Variable Message Sign (VMS)
- Advertising Signs
- Petrol Signs

ABSOLUTE MAXIMUM RATINGS ($T_A = 25^\circ\text{C}$)

Items	Symbol	Absolute Maximum Rating		Unit
		Red	Green and Blue	
Forward Current	I_F	50 ^{Note1}	35	mA
Peak Forward Current ^{Note2}	I_{FP}	200	100	mA
Reverse Voltage	V_R	5	5	V
Power Dissipation	P_D	130	140	mW
Operation Temperature	T_{opr}	-40 ~ +95		$^\circ\text{C}$
Storage Temperature	T_{stg}	-40 ~ +100		$^\circ\text{C}$
Lead Soldering Temperature	T_{sol}	Max. 260 $^\circ\text{C}$ for 3 sec. max. (3 mm from the base of the epoxy bulb)		
Electrostatic Discharge Classification (MIL-STD-883E)	ESD	Class 2		

Note:

- For long term performance the drive currents between 10mA and 30mA are recommended. Please contact Cree LED sales representative for more information on recommended drive conditions.
- Pulse width ≤ 0.1 msec, duty $\leq 1/10$.

TYPICAL ELECTRICAL & OPTICAL CHARACTERISTICS ($T_A = 25^\circ\text{C}$)

Characteristics	Color	Symbol	Condition	Unit	Minimum	Typical	Maximum
Forward Voltage	Red	V_F	$I_F = 20$ mA	V		2.1	2.6
	Blue/Green	V_F	$I_F = 20$ mA	V		3.4	4.0
Reverse Current	Red	I_R	$V_R = 5$ V	μA			100
	Blue/Green	I_R	$V_R = 5$ V	μA			100
Dominant Wavelength	Red	λ_D	$I_F = 20$ mA	nm	619	621	624
	Green	λ_D	$I_F = 20$ mA	nm	520	527	535
	Blue	λ_D	$I_F = 20$ mA	nm	460	470	475
Luminous Intensity	Red	I_V	$I_F = 20$ mA	mcd	1100	2200	
	Green	I_V	$I_F = 20$ mA	mcd	2130	4400	
	Blue	I_V	$I_F = 20$ mA	mcd	550	1100	

* Continuous reverse voltage can cause LED damage.

INTENSITY BIN LIMIT

Red (20 mA) - C5SMF-RJF/RJE				Green (20 mA) - C5SMF-GJF/GJE			
Bin Code	Sub-Bin	Min.(mcd)	Max.(mcd)	Bin Code	Sub-Bin	Min.(mcd)	Max.(mcd)
T0	T1	1100	1205	V0	V1	2130	2347
	T2	1205	1310		V2	2347	2564
	T3	1310	1415		V3	2564	2781
	T4	1415	1520		V4	2781	3000
U0	U1	1520	1672	W0	W1	3000	3295
	U2	1672	1824		W2	3295	3590
	U3	1824	1976		W3	3590	3885
	U4	1976	2130		W4	3885	4180
V0	V1	2130	2347	X0	X1	4180	4600
	V2	2347	2564		X2	4600	5020
	V3	2564	2781		X3	5020	5440
	V4	2781	3000		X4	5440	5860
W0	W1	3000	3295	Y0	Y1	5860	6445
	W2	3295	3590		Y2	6445	7030
	W3	3590	3885		Y3	7030	7615
	W4	3885	4180		Y4	7615	8200

* Tolerance of measurement of luminous intensity is $\pm 15\%$

INTENSITY BIN LIMIT

Bule (20 mA) - C5SMF-BJF/BJE			
Bin Code	Sub-Bin	Min.(mcd)	Max.(mcd)
R0	R1	550	605
	R2	605	660
	R3	660	715
	R4	715	770
S0	S1	770	852
	S2	852	934
	S3	934	1017
	S4	1017	1100
T0	T1	1100	1205
	T2	1205	1310
	T3	1310	1415
	T4	1415	1520
U0	U1	1520	1672
	U2	1672	1824
	U3	1824	1976
	U4	1976	2130

* Tolerance of measurement of luminous intensity is $\pm 15\%$

COLOR BIN LIMIT

Red (20 mA)			Green (20 mA)			Blue (20 mA)		
Bin Code	Min.(nm)	Max.(nm)	Bin Code	Min.(nm)	Max.(nm)	Bin Code	Min.(nm)	Max.(nm)
RB	619	624	G7	520	525	B3	460	465
			G8	525	530	B4	465	470
			G9	530	535	B5	470	475

* Tolerance of measurement of dominant wavelength is ± 1 nm.

ORDER CODE TABLE

C5SMF-RJF/RJE

Color	Kit Number	Luminous Intensity (mcd)		Dominant Wavelength				Package	Standoff
		Min.	Max.	Color Bin	Min. (nm)	Color Bin	Max. (nm)		
Red	C5SMF-RJF-CT0W0BB1	1100	4180	RB	619	RB	624	Bulk	Yes
Red	C5SMF-RJF-CT34QBB1	Any 4 consecutive sub-bins: T3(1310) - U4(2130)		RB	619	RB	624	Bulk	Yes
Red	C5SMF-RJF-CU14QBB1	Any 4 consecutive sub-bins: U1(1520) - V2(2564)		RB	619	RB	624	Bulk	Yes
Red	C5SMF-RJE-CT0W0BB1	1100	4180	RB	619	RB	624	Bulk	No
Red	C5SMF-RJE-CT34QBB1	Any 4 consecutive sub-bins: T3(1310) - U4(2130)		RB	619	RB	624	Bulk	No
Red	C5SMF-RJE-CU14QBB1	Any 4 consecutive sub-bins: U1(1520) - V2(2564)		RB	619	RB	624	Bulk	No
Red	C5SMF-RJF-CT0W0BB2	1100	4180	RB	619	RB	624	Ammo	Yes
Red	C5SMF-RJF-CT34QBB2	Any 4 consecutive sub-bins: T3(1310) - U4(2130)		RB	619	RB	624	Ammo	Yes
Red	C5SMF-RJF-CU14QBB2	Any 4 consecutive sub-bins: U1(1520) - V2(2564)		RB	619	RB	624	Ammo	Yes
Red	C5SMF-RJE-CT0W0BB2	1100	4180	RB	619	RB	624	Ammo	No
Red	C5SMF-RJE-CT34QBB2	Any 4 consecutive sub-bins: T3(1310) - U4(2130)		RB	619	RB	624	Ammo	No
Red	C5SMF-RJE-CU14QBB2	Any 4 consecutive sub-bins: U1(1520) - V2(2564)		RB	619	RB	624	Ammo	No

Notes:

- The above kit numbers represent order codes that include multiple intensity-bin and color-bin codes. Only one intensity-bin code and one color-bin code will be shipped on each reel. single intensity-bin, single color-bin codes will not be orderable.
- Please refer to the [HB LED Lamp Reliability Test Standards](#) document for reliability test conditions.
- Please refer to the [HB LED Lamp Soldering & Handling](#) document for information about how to use this LED product safely.

ORDER CODE TABLE

C5SMF-GJF/GJE

Color	Kit Number	Luminous Intensity (mcd)		Dominant Wavelength				Package	Standoff
		Min.	Max.	Color Bin	Min. (nm)	Color Bin	Max. (nm)		
Green	C5SMF-GJF-CV0Y0791	2130	8200	G7	520	G9	535	Bulk	Yes
Green	C5SMF-GJF-CW34Q7T1	Any 4 consecutive sub-bins: W3(3590) - X4(5860)		Any 1 color bin from G7 (520nm) to G8 (530nm)				Bulk	Yes
Green	C5SMF-GJF-CX14Q7T1	Any 4 consecutive sub-bins: X1(4180) - Y2(7030)		Any 1 color bin from G7 (520nm) to G8 (530nm)				Bulk	Yes
Green	C5SMF-GJE-CV0Y0791	2130	8200	G7	520	G9	535	Bulk	No
Green	C5SMF-GJE-CW34Q7T1	Any 4 consecutive sub-bins: W3(3590) - X4(5860)		Any 1 color bin from G7 (520nm) to G8 (530nm)				Bulk	No
Green	C5SMF-GJE-CX14Q7T1	Any 4 consecutive sub-bins: X1(4180) - Y2(7030)		Any 1 color bin from G7 (520nm) to G8 (530nm)				Bulk	No
Green	C5SMF-GJF-CV0Y0792	2130	8200	G7	520	G9	535	Ammo	Yes
Green	C5SMF-GJF-CW34Q7T2	Any 4 consecutive sub-bins: W3(3590) - X4(5860)		Any 1 color bin from G7 (520nm) to G8 (530nm)				Ammo	Yes
Green	C5SMF-GJF-CX14Q7T2	Any 4 consecutive sub-bins: X1(4180) - Y2(7030)		Any 1 color bin from G7 (520nm) to G8 (530nm)				Ammo	Yes
Green	C5SMF-GJE-CV0Y0792	2130	8200	G7	520	G9	535	Ammo	No
Green	C5SMF-GJE-CW34Q7T2	Any 4 consecutive sub-bins: W3(3590) - X4(5860)		Any 1 color bin from G7 (520nm) to G8 (530nm)				Ammo	No
Green	C5SMF-GJE-CX14Q7T2	Any 4 consecutive sub-bins: X1(4180) - Y2(7030)		Any 1 color bin from G7 (520nm) to G8 (530nm)				Ammo	No

Notes:

- The above kit numbers represent order codes that include multiple intensity-bin and color-bin codes. Only one intensity-bin code and one color-bin code will be shipped on each reel. single intensity-bin, single color-bin codes will not be orderable.
- Please refer to the [HB LED Lamp Reliability Test Standards](#) document for reliability test conditions.
- Please refer to the [HB LED Lamp Soldering & Handling](#) document for information about how to use this LED product safely.

ORDER CODE TABLE

C5SMF-BJF/BJE

Color	Kit Number	Luminous Intensity (mcd)		Dominant Wavelength				Package	Standoff
		Min.	Max.	Color Bin	Min. (nm)	Color Bin	Max. (nm)		
Blue	C5SMF-BJF-CR0U0351	550	2130	B3	460	B5	475	Bulk	Yes
Blue	C5SMF-BJF-CR0U0451	550	2130	B4	465	B5	475	Bulk	Yes
Blue	C5SMF-BJF-CT14Q3T1	Any 4 consecutive sub-bins: T1(1100) - U2(1824)		Any 1 color bin from B3 (460nm) to B4 (470nm)				Bulk	Yes
Blue	C5SMF-BJF-CT14Q4T1	Any 4 consecutive sub-bins: T1(1100) - U2(1824)		Any 1 color bin from B4 (465nm) to B5 (475nm)				Bulk	Yes
Blue	C5SMF-BJF-CT34Q3T1	Any 4 consecutive sub-bins: T3(1310) - U4(2130)		Any 1 color bin from B3 (460nm) to B4 (470nm)				Bulk	Yes
Blue	C5SMF-BJF-CT34Q4T1	Any 4 consecutive sub-bins: T3(1310) - U4(2130)		Any 1 color bin from B4 (465nm) to B5 (475nm)				Bulk	Yes
Blue	C5SMF-BJE-CR0U0351	550	2130	B3	460	B5	475	Bulk	No
Blue	C5SMF-BJE-CR0U0451	550	2130	B4	465	B5	475	Bulk	No
Blue	C5SMF-BJE-CT14Q3T1	Any 4 consecutive sub-bins: T1(1100) - U2(1824)		Any 1 color bin from B3 (460nm) to B4 (470nm)				Bulk	No
Blue	C5SMF-BJE-CT14Q4T1	Any 4 consecutive sub-bins: T1(1100) - U2(1824)		Any 1 color bin from B4 (465nm) to B5 (475nm)				Bulk	No
Blue	C5SMF-BJE-CT34Q3T1	Any 4 consecutive sub-bins: T3(1310) - U4(2130)		Any 1 color bin from B3 (460nm) to B4 (470nm)				Bulk	No
Blue	C5SMF-BJE-CT34Q4T1	Any 4 consecutive sub-bins: T3(1310) - U4(2130)		Any 1 color bin from B4 (465nm) to B5 (475nm)				Bulk	No
Blue	C5SMF-BJF-CR0U0352	550	2130	B3	460	B5	475	Ammo	Yes
Blue	C5SMF-BJF-CR0U0452	550	2130	B4	465	B5	475	Ammo	Yes
Blue	C5SMF-BJF-CT14Q3T2	Any 4 consecutive sub-bins: T1(1100) - U2(1824)		Any 1 color bin from B3 (460nm) to B4 (470nm)				Ammo	Yes
Blue	C5SMF-BJF-CT14Q4T2	Any 4 consecutive sub-bins: T1(1100) - U2(1824)		Any 1 color bin from B4 (465nm) to B5 (475nm)				Ammo	Yes
Blue	C5SMF-BJF-CT34Q3T2	Any 4 consecutive sub-bins: T3(1310) - U4(2130)		Any 1 color bin from B3 (460nm) to B4 (470nm)				Ammo	Yes
Blue	C5SMF-BJF-CT34Q4T2	Any 4 consecutive sub-bins: T3(1310) - U4(2130)		Any 1 color bin from B4 (465nm) to B5 (475nm)				Ammo	Yes
Blue	C5SMF-BJE-CR0U0352	550	2130	B3	460	B5	475	Ammo	No
Blue	C5SMF-BJE-CR0U0452	550	2130	B4	465	B5	475	Ammo	No
Blue	C5SMF-BJE-CT14Q3T2	Any 4 consecutive sub-bins: T1(1100) - U2(1824)		Any 1 color bin from B3 (460nm) to B4 (470nm)				Ammo	No
Blue	C5SMF-BJE-CT14Q4T2	Any 4 consecutive sub-bins: T1(1100) - U2(1824)		Any 1 color bin from B4 (465nm) to B5 (475nm)				Ammo	No
Blue	C5SMF-BJE-CT34Q3T2	Any 4 consecutive sub-bins: T3(1310) - U4(2130)		Any 1 color bin from B3 (460nm) to B4 (470nm)				Ammo	No
Blue	C5SMF-BJE-CT34Q4T2	Any 4 consecutive sub-bins: T3(1310) - U4(2130)		Any 1 color bin from B4 (465nm) to B5 (475nm)				Ammo	No

Notes:

- The above kit numbers represent order codes that include multiple intensity-bin and color-bin codes. Only one intensity-bin code and one color-bin code will be shipped on each reel. single intensity-bin, single color-bin codes will not be orderable.
- Please refer to the [HB LED Lamp Reliability Test Standards](#) document for reliability test conditions.
- Please refer to the [HB LED Lamp Soldering & Handling](#) document for information about how to use this LED product safely.

GRAPHS

The data below are collected from statistical figures that do not necessarily correspond to the actual parameters of each single LED. Hence, these data will be changed without further notice.

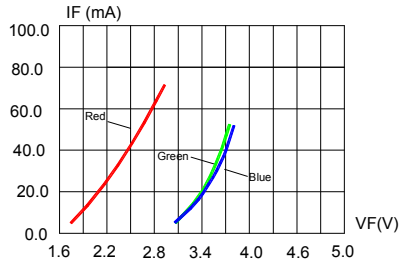

FIG.1 FORWARD CURRENT VS. FORWARD VOLTAGE.

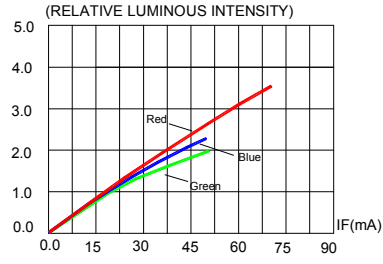

FIG.2 RELATIVE LUMINOUS INTENSITY VS. FORWARD CURRENT

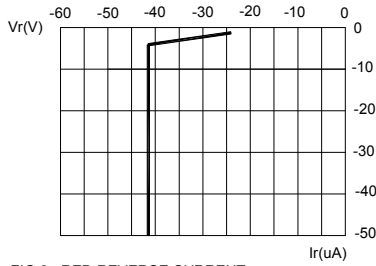

FIG.3a RED REVERSE CURRENT VS. REVERSE VOLTAGE.

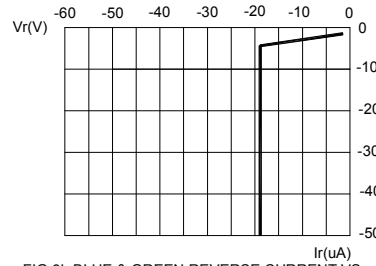

FIG.3b BLUE & GREEN REVERSE CURRENT VS. REVERSE VOLTAGE.

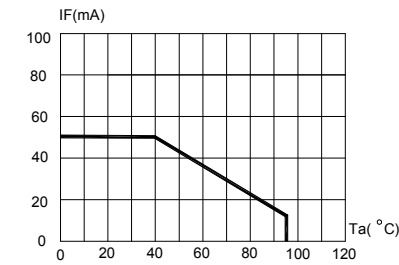

FIG.4a RED MAXIMUM FORWARD DC CURRENT VS AMBIENT TEMPERATURE ($T_{jmax}=105^{\circ}C$)

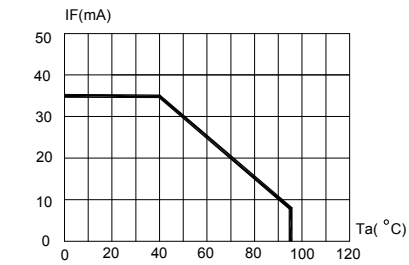

FIG.4b BLUE & GREEN MAXIMUM FORWARD DC CURRENT VS AMBIENT TEMPERATURE ($T_{jmax}=105^{\circ}C$)

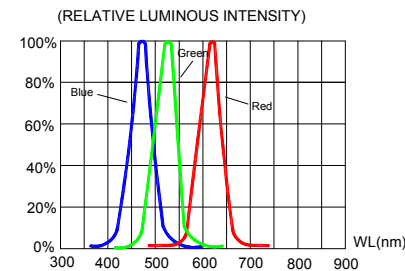

FIG.5 RELATIVE LUMINOUS INTENSITY VS. WAVELENGTH.

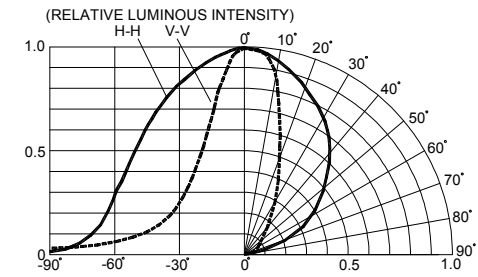

FIG.6 RED & BLUE&GREEN FAR FIELD PATTERN

MECHANICAL DIMENSIONS

All dimensions are in mm. Tolerance is ± 0.25 mm unless otherwise noted.

An epoxy meniscus may extend about 1.5 mm down the leads.

Burr around bottom of epoxy may be 0.5 mm max.

C5SMF-RJF/GJF/BJF:

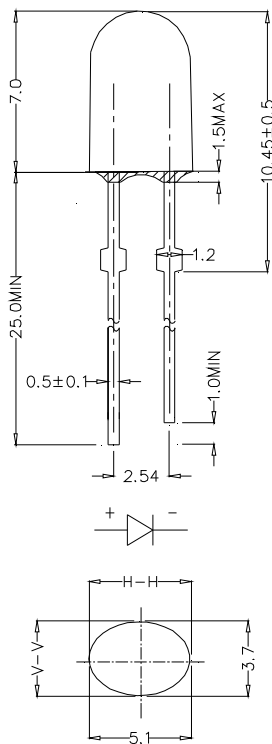

C5SMF-RJE/GJE/BJE:

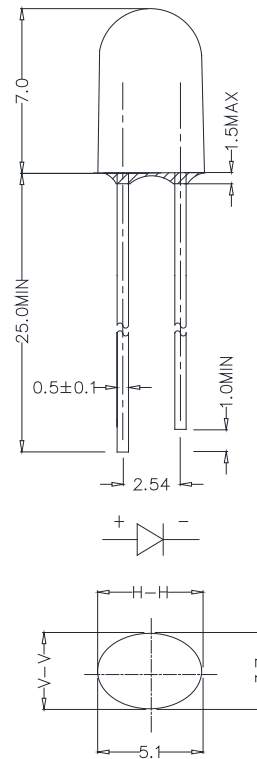

NOTES

Lead Frame Materials

Ag-plated and Lead-free Solder-plated iron.

RoHS Compliance

The levels of RoHS restricted materials in this product are below the maximum concentration values (also referred to as the threshold limits) permitted for such substances, or are used in an exempted application, in accordance with EU Directive 2011/65/EC (RoHS2), as implemented January 2, 2013. RoHS Declarations for this product can be obtained from your Cree LED representative or from the [Product Ecology](#) section of the Cree LED website.

Vision Advisory

WARNING: Do not look at an exposed lamp in operation. Eye injury can result.

KIT NUMBER SYSTEM

Cree LED lamps are tested and sorted into performance bins. A bin is specified by ranges of color, forward voltage, and brightness. Sorted LEDs are packaged for shipping in various convenient options.

Cree LEDs are sold by order codes in combinations of bins called kits. Order codes are configured in the following manner:

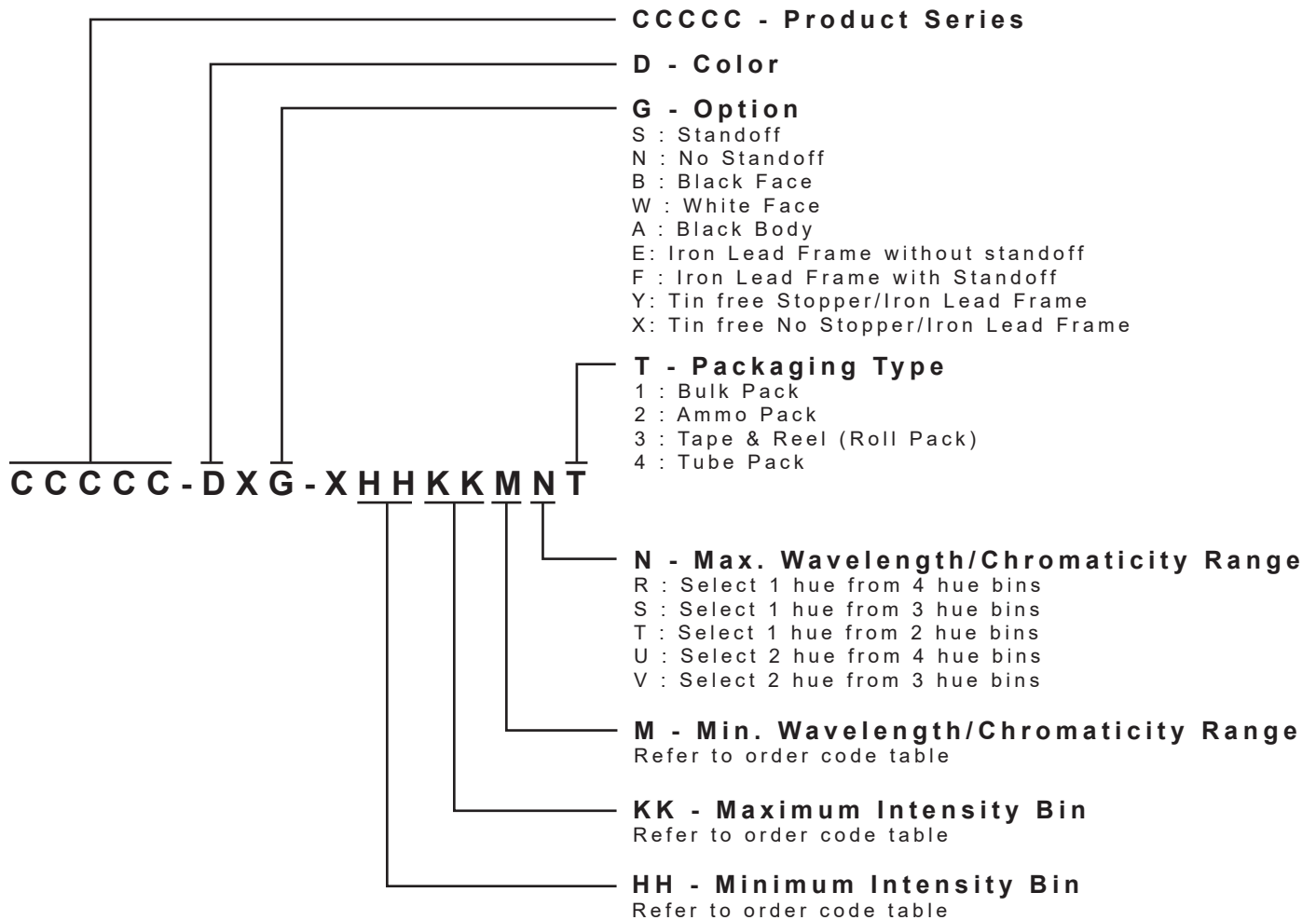

* Please contact our sales representative for ordering information.

SOLDERING GUIDELINES

The LED soldering specification is shown below (suitable for both leaded solder & lead-free solder):

Manual Soldering		Solder Dipping	
Soldering iron	35 W max	Preheat	110 °C max
Temperature	300 °C max	Preheat time	60 seconds max
		Solder-bath temperature	260 °C Max
Soldering time	3 seconds max	Dipping time	5 seconds max
Position	Not less than 3 mm from the base of the package.	Position	Not less than 3 mm from the base of the package.

- Manual soldering onto the PCB is not recommended because soldering time is uncontrollable.
- The recommended wave soldering is as below:

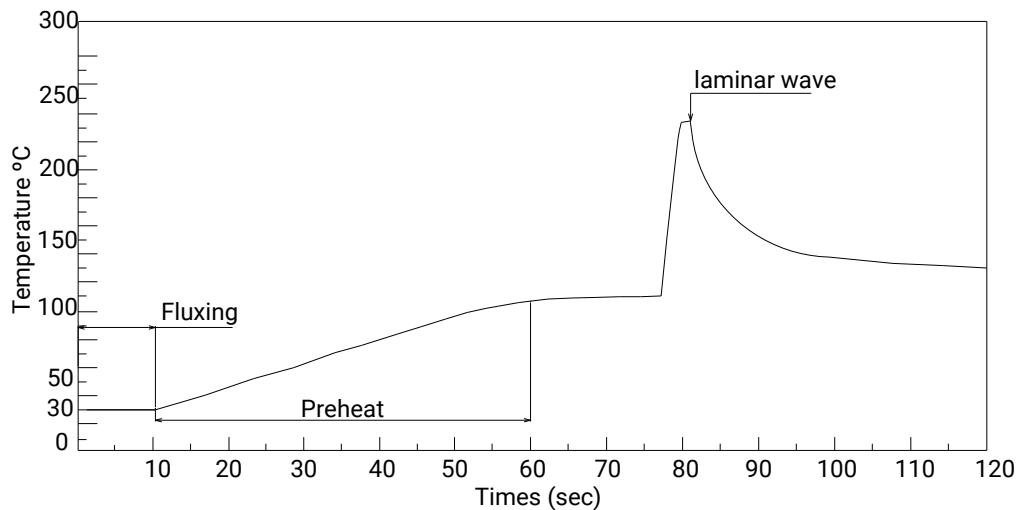

- Do not apply any stress to the LED package, particularly when heated.
- Only bottom preheat is suggested & should not preheat on top in order to reduce thermal stress experienced by the LEDs.
- The LEDs must not be re used once they have been extracted from PCB.
- After soldering the LEDs, the package should be protected from mechanical shock or vibration until the LEDs have reached 40 °C or below.
- Precautions must be taken as mechanical stress on the LEDs may be caused by PCB warpage or from the clinching and cutting of the LED leads.
- When it is necessary to clamp the LEDs during soldering, it is important to ensure no mechanical stress is exerted on the LEDs.
- Cut the LED lead at normal room temperature. Lead cutting at high temperature may cause failure of the LEDs.
- Please refer to the [HB LED Lamp Soldering & Handling](#) document for information about how to use this LED product safely.

PACKAGING

- The LEDs are packed in cardboard boxes after packaging in normal or anti-electrostatic bags.
- Cardboard boxes will be used to protect the LEDs from mechanical shock during transportation.
- The boxes are not water resistant, and they must be kept away from water and moisture.
- Max 500 pcs per bulk and Max 2500 pcs per ammo.

Bulk Pack Packaging Type:

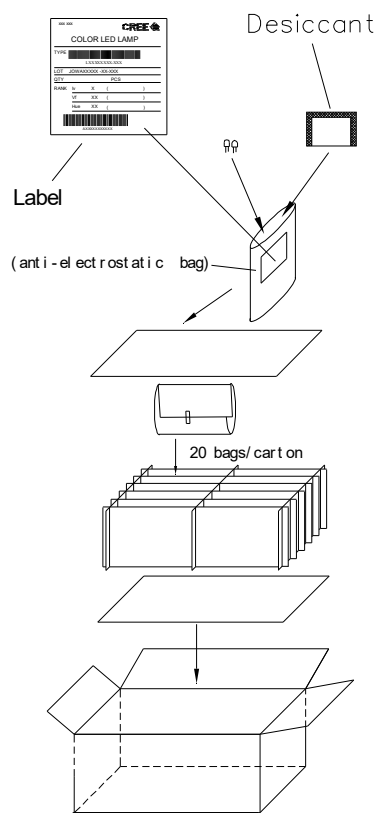

Ammo Pack Packaging Type:

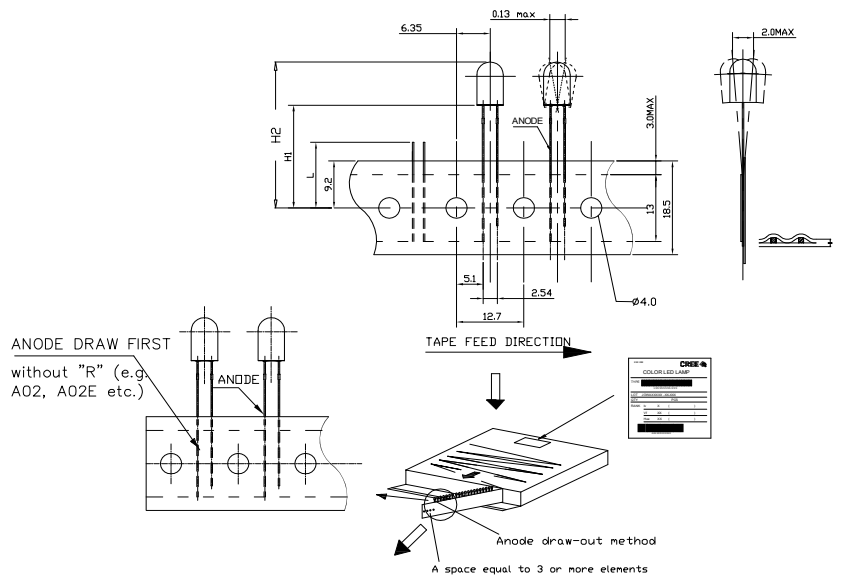

Looking for pricing, stock, or lifecycle information?

Click below to explore more details on WIN SOURCE:

 [View C5SMF-RJF-CT0W0BB1 on WIN SOURCE](#)

 [Cree Inc. Information](#)

Optimize Your Supply Chain with WIN SOURCE Solutions

-  Global Sourcing Solution
-  Obsolete Management
-  Cost Control Management
-  Shortage Management
-  Alternative Solution
-  Excess Inventory Management