

IEC Appliance Inlet C14, Screw-on Mounting, Front or Rear Side, Solder or Quick-connect Terminal



See below:
[Approvals and Compliances](#)

Description

- Panel mount :
 Screw-on mounting , front / rear-side
- Appliance Inlet , Pin temperature 70 °C , Protection class I
- Solder / Quick Connect

Weblinks

[pdf data sheet](#), [html datasheet](#), [General Product Information](#), [Approvals](#), [Distributor-Stock-Check](#), [Accessories](#), [Detailed request for product](#)

Newly available variants corresponding to V-Lock mating cordset. The connector is equipped with a notch intended for use with the latching cordset. The cord latching system prevents against accidental removal of the cordset.

Technical Data

Ratings IEC	10A / 250VAC; 50Hz	Appliance inlet/-outlet	C14 acc. to IEC 60320-1
Ratings UL/CSA	15A / 250VAC; 60Hz		UL 60320-1, CSA C22.2 no. 60320-1
Dielectric Strength	> 3kVAC between L-N > 1.5kVAC between L/N-PE (1 min/50Hz)		(for cold conditions) pin-temperature 70 °C, 10A, Protection Class I
Allowable Operation Temperature	-25 °C to 70 °C		
IP-Protection	front side IP20 acc. to IEC 60529		
Protection against electric shock	Suitable for appliances with protection class I acc. to IEC 61140		
Material: Housing	PA6, black, UL 94V-0		

Approvals and Compliances

Detailed information on product approvals, code requirements, usage instructions and detailed test conditions can be looked up in [Details about Approvals](#)

SCHURTER products are designed for use in industrial environments. They have approvals from independent testing bodies according to national and international standards. Products with specific characteristics and requirements such as required in the automotive sector according to IATF 16949, medical technology according to ISO 13485 or in the aerospace industry can be offered exclusively with customer-specific, individual agreements by SCHURTER.



Approvals

The approval mark is used by the testing authorities to certify compliance with the safety requirements placed on electronic products.
 Approval Reference Type: 6048

Approval Logo	Certificates	Certification Body	Description
	VDE Approvals	VDE	Certificate Number: 40011871
	UL Approvals	UL	UR File Number: E96454

Product standards

Product standards that are referenced

Organization	Design	Standard	Description
	Designed according to	IEC 60320-1	Appliance couplers for household and similar general purposes
	Designed according to	UL 60320-1	Standard for Attachment Plugs and Receptacles
	Designed according to	CSA C22.2 no. 60320-1	General Use Receptacles, Attachment Plugs, and Similar Wiring Devices







Application standards

Application standards where the product can be used

Organization	Design	Standard	Description
	Suitable for applications acc.	IEC/UL 62368-1	Audio/video, information and communication technology equipment - Part 1: Safety requirements

Compliances

The product complies with following Guide Lines

Identification	Details	Initiator	Description
	CE declaration of conformity	SCHURTER AG	The CE marking declares that the product complies with the applicable requirements laid down in the harmonisation of Community legislation on its affixing in accordance with EU Regulation 765/2008.
	UKCA declaration of conformity	SCHURTER AG	The UKCA marking declares that the product complies with the applicable requirements laid down in the British Amendment of Regulation (EC) 765/2008.
	RoHS	SCHURTER AG	Directive RoHS 2011/65/EU, Amendment (EU) 2015/863
	China RoHS	SCHURTER AG	The law SJ / T 11363-2006 (China RoHS) has been in force since 1 March 2007. It is similar to the EU directive RoHS.
	REACH	SCHURTER AG	On 1 June 2007, Regulation (EC) No 1907/2006 on the Registration, Evaluation, Authorization and Restriction of Chemicals 1 (abbreviated as "REACH") entered into force.
		SCHURTER AG	V-Lock system are based on a matching plug-dose combination. The connector is equipped with a notch intended for use with the latching cordset. The cord latching system prevents against accidental removal of the cordset.

Dimensions [mm]

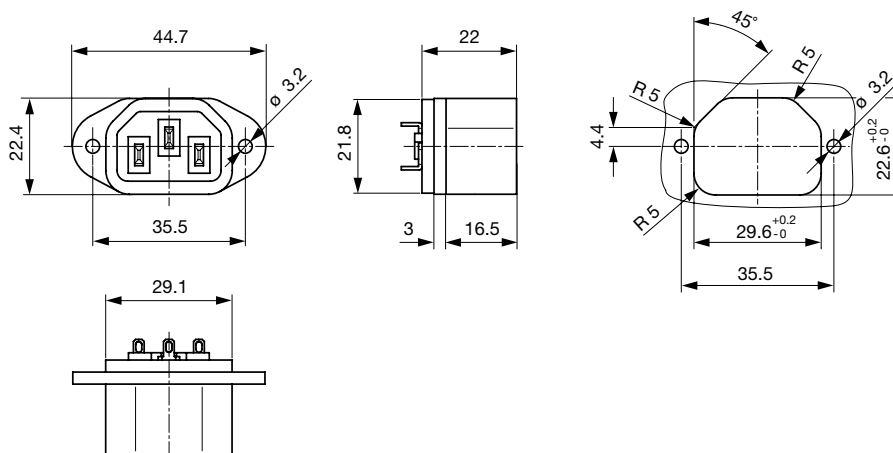

Length of the terminal please find at the order code configuration table

Config. Code





6048 - H - A B C 0 - D - E O

The characters are placeholders for the correspondingly keys of selections from the key tables.

6048 - **H** - A B C 0 - D - E O = Type

Type	Configuration key
protection class I	X

6048 - H - A B C 0 - D - E O = Terminals

Terminal L	Configuration key
Solder terminal (L = 5.0mm) large soldering hole 	1
short solder terminal (L = 4.8 mm) 	2
long solder terminal (L = 8.5 mm) 	3
Blade terminal (4.8 x 0.8 mm) 	8
Blade terminal (6.3 x 0.8 mm) 	9

6048 - H - A B C 0 - D - E O = Terminals

Terminal N	Configuration key
Solder terminal (L = 5.0mm) large soldering hole	1
short solder terminal (L = 4.8 mm)	2
long solder terminal (L = 8.5 mm)	3
Blade terminal (4.8 x 0.8 mm)	8
Blade terminal (6.3 x 0.8 mm)	9

Symbols similar as in table A

6048 - H - A B C 0 - D - E O = Terminals

Terminal Ground	Configuration key
Solder terminal (L = 5.0mm) large soldering hole	1
short solder terminal (L = 4.8 mm)	2
long solder terminal (L = 8.5 mm)	3
Blade terminal (4.8 x 0.8 mm)	8
Blade terminal (6.3 x 0.8 mm)	9

Symbols similar as in table A

6048 - H - A B C 0 - D - E O = Color

Color	Configuration key
Black	A

6048 - H - A B C 0 - D - E O = Style

Style	Configuration key
flange with through holes	2

6048 - H - A B C 0 - D - E O = Features

Features	Configuration key
without V-Lock	0
V-Lock	V

Variants

Terminals L / N	Terminal Ground	Color	Features	Config. Code	Order Number
Solder terminal short (L = 4.8 mm)	Solder terminal short (L = 4.8 mm)	black	-	6048-X-2220-A-20	6162.0040
Quick connect terminal (4.8 x 0.8 mm)	Quick connect terminal (4.8 x 0.8 mm)	black	-	6048-X-8880-A-20	6162.0042
Quick connect terminal (6.3 x 0.8 mm)	Quick connect terminal (6.3 x 0.8 mm)	black	-	6048-X-9990-A-20	6162.0043
Solder terminal short (L = 4.8 mm)	Solder terminal short (L = 4.8 mm)	black	V-Lock	6048-X-2220-A-2V	6162.0174

The listed variants should be available from stock. Other versions on request www.schurter.com/contact

Availability for all products can be searched real-time: <https://www.schurter.com/en/info-center/support-tools/stock-check-distributors>

Packaging unit

50 Pcs

Mating Outlets/Connectors

Category / Description

[Appliance Outlet Overview complete](#)

4787, Mounting: Screw-on mounting, Appliance Outlet: IEC Solder terminals, 10 A, Suitable for appliances with protection class I	4787
4788, Mounting: Snap-in version, Appliance Outlet: IEC Solder / Quick Connect, 10 A, Suitable for appliances with protection class I	4788
IEC Appliance Outlet F or H, Screw-on Mounting, Front Side, Solder, PCB or Quick-connect Terminal	5091

[Connector Overview complete](#)

4782 Mounting: Power Cord, 3 x 1 mm ² / 3 x 18 AWG, Cable, Connector: IEC C13	4782
4785 Mounting: Power Cord, 3 x 1 mm ² / 3 x 18 AWG, Cable, Connector: IEC C13	4785
4300-06 Mounting: Power Cord, 3 x 1 mm ² / 3 x 18 AWG, Cable, Connector: IEC C13	4300-06
4781 Mounting: Power Cord, Cable, Connector: IEC C15	4781
4784 Mounting: Power Cord, 3 x 1 mm ² / 3 x 18 AWG, Cable, Connector: IEC C15	4784

Mating Outlets/Connectors shuttered

[Connector Overview complete](#)

4783 Mounting: Power Cord, 3 x 1 mm ² / 3 x 18 AWG, Cable, Connector: IEC C13	4783
--	------

[Power Cord Overview complete](#)

VAC13KS, Overview, V-Lock cord retaining, diverse Connector IEC C13, diverse, black	VAC13KS
---	---------

Looking for pricing, stock, or lifecycle information?

Click below to explore more details on WIN SOURCE:

 [View 6162.0040 on WIN SOURCE](#)

 [Schurter Inc. Information](#)

Optimize Your Supply Chain with WIN SOURCE Solutions

-  Global Sourcing Solution
-  Obsolete Management
-  Cost Control Management
-  Shortage Management
-  Alternative Solution
-  Excess Inventory Management