

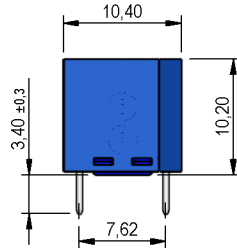

**THE DATASHEET OF
DIL05-2C90-63L**

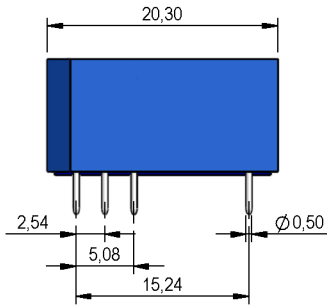

Dimensions mm[inch]
 tolerances acc. to DIN ISO 2768-m
 Toleranzen gem. DIN ISO 2768-m



Layout
 Top view
 Draufsicht

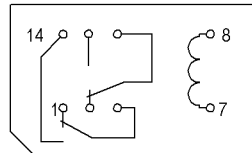

Isometric
 Scale 1:2
 Maßstab 1:2

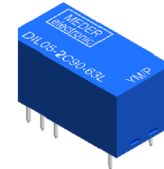

Marking
 according to EN60062/factory code
 gem. EN60062/Fertigungsstätte

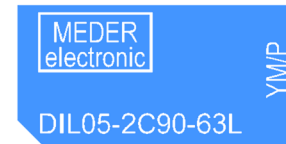

Coil Data at 20 °C	Conditions	Min	Typ	Max	Unit
Coil resistance		135	150	165	Ohm
Coil voltage			5		VDC
Rated power			167		mW
Pull-In voltage				3,5	VDC
Drop-Out voltage		0,75			VDC

Contact data 90	Conditions	Min	Typ	Max	Unit
Contact rating	Any DC combination of V & A not to exceed their individual max.'s			10	W
Switching voltage	DC or Peak AC/ with 40% overdrive			175	V
Switching current	DC or Peak AC/with 40% overdrive			250	mA
Carry current	DC or Peak AC/ with 40% overdrive			1	A
Contact resistance static	Measured with 40% overdrive Start Value			150	mOhm
Insulation resistance	RH <45 %, 100 V test voltage	1			TOhm
Breakdown voltage	according to EN 60255-5	200			VDC
Operate time, incl. bounce	measured with 40% overdrive			0,7	ms
Release time	measured with no coil excitation			1,5	ms
Capacity	@ 10 kHz across open switch		1		pF

Special Product Data	Conditions	Min	Typ	Max	Unit
Number of contacts				2	
Contact - form				Form C - Changeover	
Dielectric Strength Coil/Contact	according to EN 60255-5	1,5			kV DC
Insulation resistance Coil/Contact	RH <45%, 200 VDC test voltage	1			TOhm
Case colour				blue	
Housing material				PBT glass fibre reinforced	
Sealing compound				Polyurethan	
Connection pins				Copper alloy tin plated	
Reach / RoHS conformity				yes	



Products for tomorrow...

Europe: +49 / 7731 8399 0 | Email: info@meder.com
USA: +1 / 508 295 0771 | Email: salesusa@meder.com
Asia: +852 / 2955 1682 | Email: salesasia@meder.com

Item No.:
1305290063
Item:
DIL05-2C90-63L

Environmental data	Conditions	Min	Typ	Max	Unit
Shock	1/2 sine wave duration 11ms			50	g
Vibration	from 10 - 2000 Hz			20	g
Operating temperature		-20		70	°C
Storage temperature		-25		85	°C
Soldering temperature	wave soldering max. 5 sec.			260	°C
Washability					fully sealed



General data	Conditions	Min	Typ	Max	Unit
Packaging					plastik tube a 25 pcs.

Modifications in the sense of technical progress are reserved

Designed at: 11.02.09 Designed by: MPOTUZAK Approval at: 12.02.09 Approval by: DSTASTNY
Last Change at: 20.12.12 Last Change by: SSCHNECKENBURGER Approval at: 20.12.12 Approval by: SSCHNECKENBURGER Version: 08

Looking for pricing, stock, or lifecycle information?

Click below to explore more details on WIN SOURCE:

-  [View DIL05-2C90-63L on WIN SOURCE](#)
-  [Standex-Meder Electronics](#) Information

Optimize Your Supply Chain with WIN SOURCE Solutions

-  Global Sourcing Solution
-  Obsolete Management
-  Cost Control Management
-  Shortage Management
-  Alternative Solution
-  Excess Inventory Management