



**THE DATASHEET OF**  
**8161J86ZQE223**



# 8060 Series

## Alternate Action and Momentary Pushbutton Switches

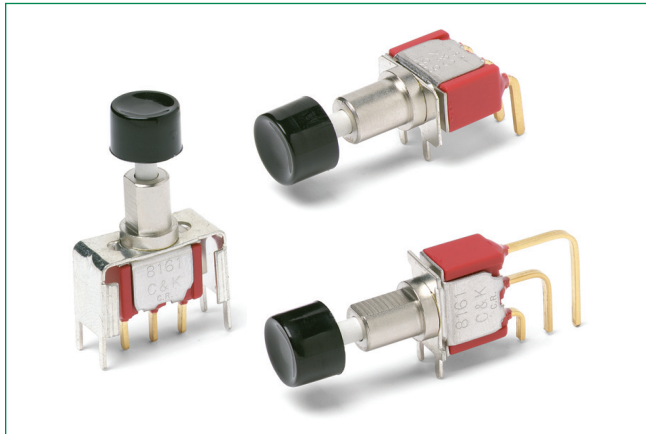

### Agency Approvals

Agency	Agency File Number
cUL US	E42363

### Specifications

<b>Contact Rating</b>	Q contact material: 6 AMPS @ 120 V AC or 28 V DC; 3 AMPS @ 250 V AC. See page 10 for additional ratings.
<b>Electrical Life</b>	50,000 make-and-break cycles at full load.
<b>Contact Resistance</b>	Below 20 mΩ typ. initial @ 2-4 V DC, 100 mA, for both silver and gold plated contacts.
<b>Insulation Resistance</b>	10 <sup>9</sup> Ω min.
<b>Dielectric Strength</b>	1000 Vrms min. @ sea level.
<b>Operating Temperature</b>	-30°C to 65°C
<b>Cap Installation Force</b>	10 lbs. Max. permissible
<b>Solderability</b>	Per MIL-STD-202F method 208D, or EIA RS-186E method 9 (1 hour steam aging).

#### Notes:

Any models supplied with P, R, S, Q, B or G contact material are RoHS compliant. Specifications and materials listed above are for switches with standard options. For information on specific and custom switches, consult Customer Service Center.

### Description

Leading telecommunications and networking equipment designers turn to C&K for its 8060 series alternate action and momentary pushbutton switches. 8060 switches are high-performing and long-lasting, are available with LEDs – and are epoxy terminal seal-compatible with bottom wash cleaning.

### Features & Benefits

- Long travel
- Available with LED
- Long life contact design
- Epoxy terminal seal compatible with bottom wash cleaning
- RoHS compliant models available

### Applications

- Instrumentation
- Computers and peripherals
- Telecommunications and networking equipment

### Materials

<b>Case</b>	Glass filled nylon 6/6 or diallyl phthalate (DAP), flame retardant (UL 94V-0).
<b>Plunger</b>	S, S1, S2 Options: Glass filled nylon or glass filled polyester (PBT) (UL 94V-0). L, L1 Options: Brass, nickel plated.
<b>Cap &amp; Frame</b>	Nylon, black, standard.
<b>Bushing</b>	Brass or zinc, nickel plated
<b>Housing</b>	Stainless Steel
<b>Switch Support</b>	Brass or steel, matte-tin plated.
<b>End Contacts</b>	Q contact material: Coin silver, silver plated. See page 10 for additional contact materials.
<b>Center Contacts &amp; All Terminals</b>	Q contact material: Copper alloy, silver plated. See page 10 for additional contact materials.
<b>Terminal Seal</b>	Epoxy. Refer to soldering and cleaning Technical Data Chapter.
<b>Hardware</b>	Nut & Locking Ring: Brass, nickel plated; Lockwasher: Steel, nickel plated.

# 8060 Series

## Alternate Action and Momentary Pushbutton Switches



### Ordering Number

To order, simply select desired option from each category and place in the appropriate box. Available options are shown and described below. For additional options not shown in catalog, consult Customer Service Center. All models have epoxy terminal seal and are compatible with all "bottom-wash" PCB cleaning methods.

**X - X - X - X - X - X - X - X - X - X**

<p><b>Switch Function</b>  <b>8161:</b> SPDT On-On  <b>8168:</b> SPDT On-Mom.</p> <p><b>Actuator or Plunger</b>  <b>S:</b> 0.710" high plunger with 0.375" dia. cap  <b>J80:</b> Snap-in  <b>J81:</b> Snap-in w/ frame  <b>J82:</b> Snap-in w/ frame for LED  <b>J86:</b> Snap-in w/ frame &amp; LED  <b>L:</b> 0.740" high plunger with 0.395" dia. cap  <b>L1:</b> 0.740" high plunger with 0.590" dia. cap  <b>S1:</b> 0.615" high plunger with 0.200" dia. cap  <b>S2:</b> 0.710" high plunger with 0.310" dia. cap</p> <p><b>Bushing</b>  <b>H:</b> 0.300" high, flat, hi torque  <b>H9:</b> 0.300" high, flat, hi torque  <b>NONE:</b> No bushing choice required  <b>Y3:</b> 7.6mm, keyway</p> <p><b>Terminations</b>  <b>A:</b> Right angle, PC Thru-hole  <b>AV2:</b> Vertical right angle, PC Thru-hole  <b>C:</b> PC Thru-hole  <b>Z:</b> Solder lug  <b>A3:</b> Vertical right angle, snap-in, PC Thru-hole</p>	<p><b>LED Color</b>  <b>3:</b> Red  <b>None:</b> Models without LED</p> <p><b>Frame Color</b>  <b>2:</b> Black</p> <p><b>Cap Color</b>  <b>2:</b> Black    <b>4:</b> Orange  <b>1:</b> White    <b>5:</b> Yellow  <b>3:</b> Red        <b>9:</b> Gray</p> <p><b>Seal</b>  <b>E:</b> Epoxy  <b>I:</b> Epoxy potted base</p> <p><b>Contact Material</b>  <b>B:</b> Gold  <b>P:</b> Gold, matte-tin  <b>Q:</b> Silver  <b>S:</b> Silver, matte-tin  <b>G:</b> Gold over silver  <b>R:</b> Gold over silver, matte tin</p>	<p><b>AV3:</b> Vertical right angle, snap-in, PC thru-hole  <b>V3:</b> 0.460" high, V-bracket  <b>V4:</b> 0.630" high, V-bracket  <b>V6:</b> 0.460" high, V-bracket</p> <p><b>V21:</b> 0.555" high, snap-in V-bracket  <b>V31:</b> 0.460" high, snap-in V-bracket  <b>W:</b> 0.750" long, wire wrap  <b>Z3:</b> Quick connect</p>
---	--	---

### Switch Function

#### SPDT

No. Poles	Mo. Poles	Switch Function		Connected Terminals		Schematic
		POS. 1	POS. 2	POS. 1	POS. 2	
		C&K marking this side				
SP	8161	ON	ON	2-3	2-1	
	8168	ON	MOM.	2-3	2-1	

### Dimensions: inches(mm)

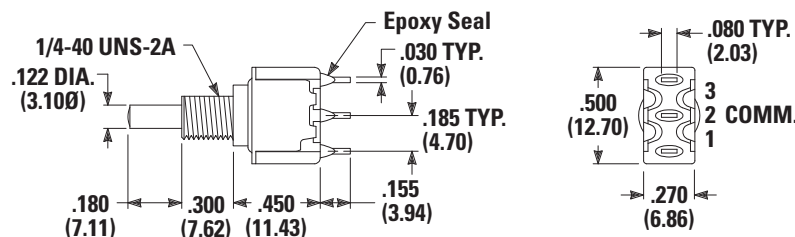

Part Number Shown: 8161SHZQE

Terminal Nos. For Reference Only

# 8060 Series

## Alternate Action and Momentary Pushbutton Switches



### DPDT

No. Poles	Mo. Poles	Switch Function		Connected Terminals		Schematic
		POS. 1 	POS. 2 	POS. 1 	POS. 2 	
C&K marking this side						
DP	8261	ON	ON	2-3, 5-6	2-1, 5-4	

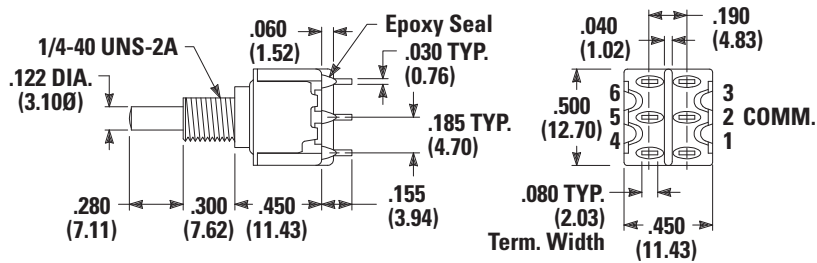

Part Number Shown: 8221SHZGE

Terminal Nos. For Reference Only

### Actuator - Snap-in Front Mount

#### J80 Snap-in

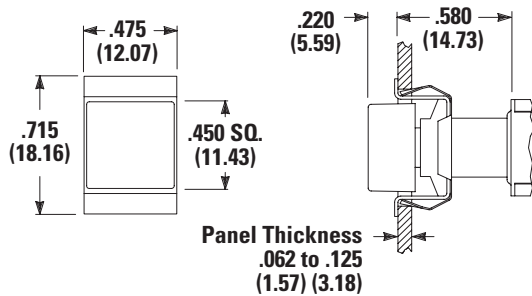

#### PC Mounting

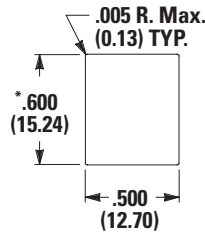

**Notes:**  
Increase this dimension to 0.620/0.625 (15.75/15.88) for 0.091/0.125 (2.41/2.18) thick panels.

Option Code	Cap Color
2	Black
1	White
3	Red
4	Orange
5	Yellow
9	Gray

#### J81 Snap-in with Black Frame

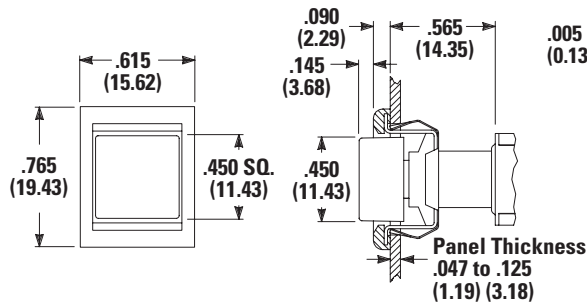

#### PC Mounting

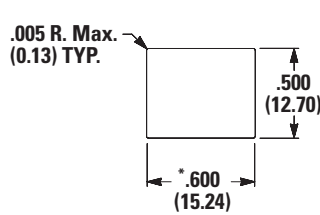

**Notes:**  
Increase this dimension to 0.620/0.625 (15.75/15.88) for 0.091/0.125 (2.41/2.18) thick panels.

**Notes:**  
Cap Finish: matte. Other colors available, consult Customer Service Center. Available with C, W, Z or Z3 terminations. Caps & frames available separately, see pages 11-13.

# 8060 Series

## Alternate Action and Momentary Pushbutton Switches



### J82 Snap-in with Black Frame for LED

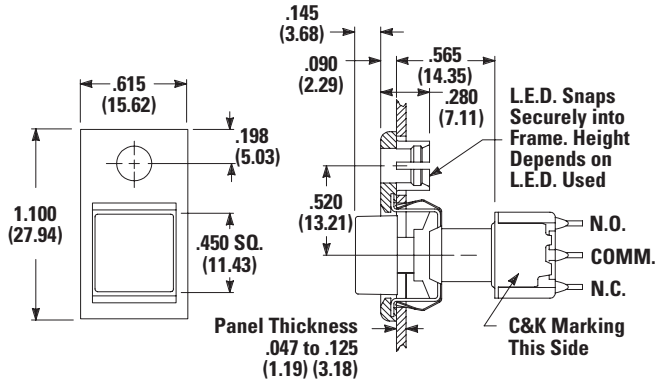

**Notes:**  
Available with C, W, Z or Z3 terminations.

### PC Mounting

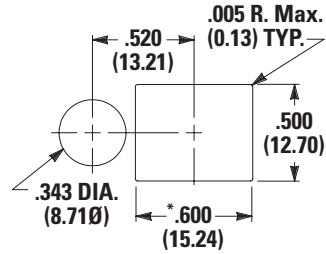

**Notes:**  
\*Increase this dimension to 0.620/0.625 (15.75/15.88) for 0.091/0.125 (2.41/2.18) thick panels.

Option Code	Cap Color
2	Black
1	White
3	Red
4	Orange
5	Yellow
9	Gray

**Notes:**  
LED not included. For LED information, see page 13. Caps & frames available separately, see pages 11-13. Other colors available, consult Customer Service Center.

### J86 Snap-in with Black Frame and LED 8161J86ZQE223 SPDT

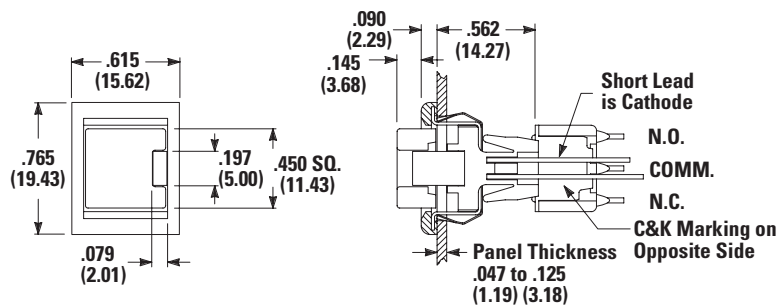

**Notes:**  
Available with C, W, Z or Z3 terminations and SPDT models only.

### PC Mounting

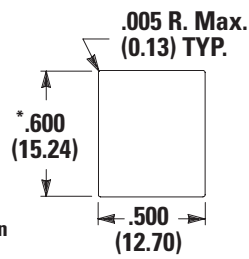

**Notes:**  
\*Increase this dimension to 0.620/0.625 (15.75/15.88) for 0.091/0.125 (2.41/2.18) thick panels.

Option Code	Cap Color
2	Black
1	White
3	Red
4	Orange
5	Yellow
9	Gray

**Notes:**  
Caps & frames available separately, see pages 11-13. Other colors available, consult Customer Service Center.

Option Code	LED Color
3	Red

**Notes:**  
For LED information, see page 13.

# 8060 Series

## Alternate Action and Momentary Pushbutton Switches



### Plunger

**S Plunger with Cap P/N 7527**

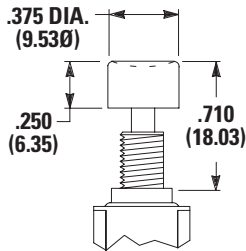

**S1 Plunger with Cap P/N 7089**

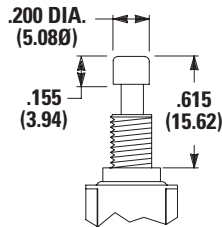

**S2 Plunger with Cap P/N 8018**

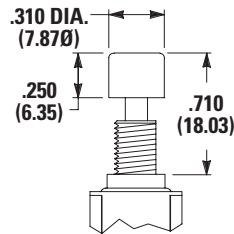

**S, S1, S2, Plunger Dimensions**

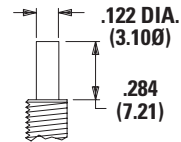

Plunger material: Glass filled nylon or glass filled polyester (UL 94 V-0)

**L Plunger with Cap P/N 8941**

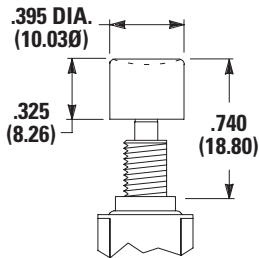

**L1 Plunger with Cap P/N 8940**

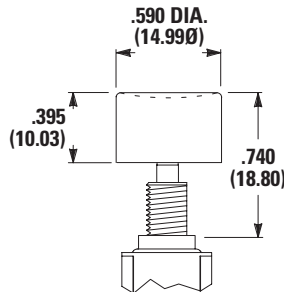

**L, L1 Plunger Dimensions**

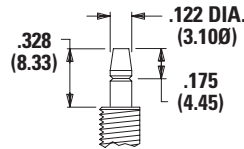

Plunger material: Brass, chrome plated.

Option Code	Cap Color
2	Black
1	White
3	Red
4	Orange
5	Yellow
9	Gray

**Notes:**  
Cap Finish: gloss. Cap supplied not installed.  
Other colors available, consult Customer Service Center.

**Notes:** When selecting plunger and cap option, bushing selection must also be made, see below.

### Bushing

**H 0.300" High Threaded, Flat H9 0.300" High Unthreaded, Flat**

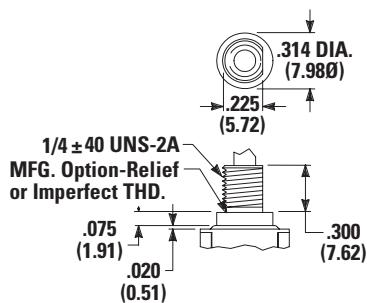

**None No Bushing Choice Required (JXX Actuators)**

**Y3 7.6mm Threaded, Keyway**

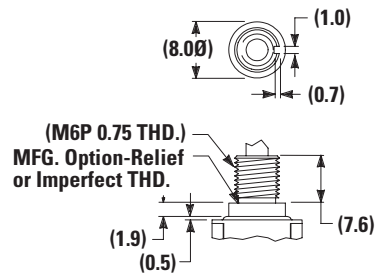

**Notes:**  
Withstands 12 in./lbs. of torque with no distortion.

**Notes:**  
H bushing standard with C, W, Z or Z3 terminations. H9 bushing standard with A, A3, AV2, AV3, or V3-V31 terminations. Withstands 12 in./lbs. of torque with no distortion.

When selecting bushing option, plunger selection must also be made, see above. No bushing option choice required when any JXX actuator option is selected.

# 8060 Series

## Alternate Action and Momentary Pushbutton Switches



### Panel Mounting

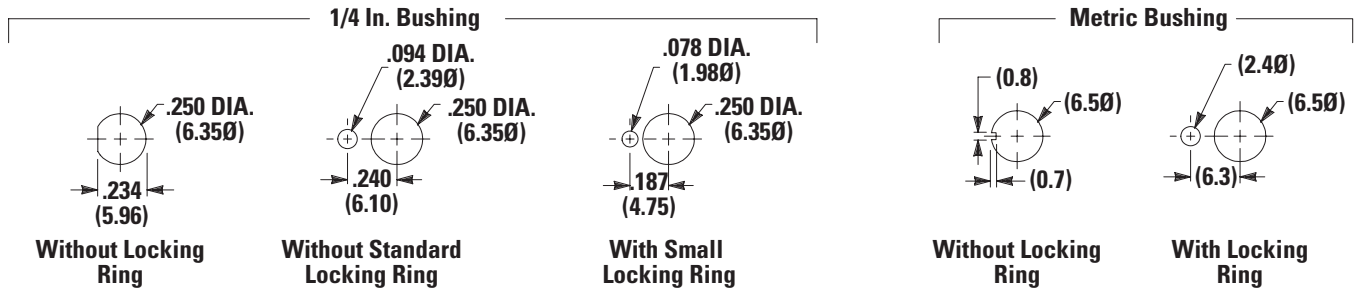

**Notes:** Two mounting nuts, locking ring and lockwasher supplied standard with threaded bushings. Optional mounting nut and locking ring styles and finishes available, see section "Technical Data and Additional Hardware".

### Terminations

#### C PCThu-hole SPDT and DPDT

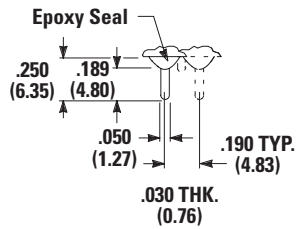

#### PC Mounting

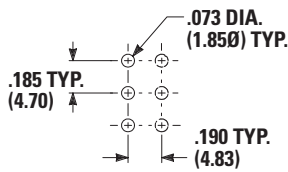

#### Z Solder Lug SPDT and DPDT

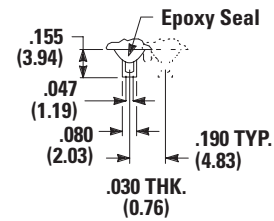

**Notes:** Not available with P, S or R contact material.

#### Z3 Quick Connect SPDT and DPDT

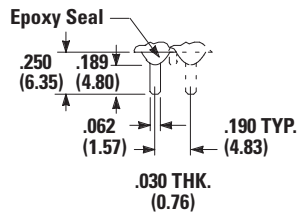

#### W Wire Wrap SPDT and DPDT

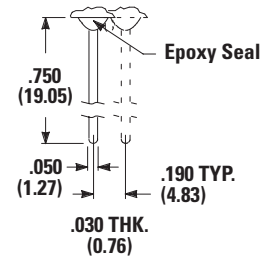

**Notes:** Not available with P, S or R contact material. Mating quick connector available; order part number 530100000, page 12.

# 8060 Series

## Alternate Action and Momentary Pushbutton Switches



### A Right Angle, PC Thru-hole

#### 8161SH9ABE2 SPDT

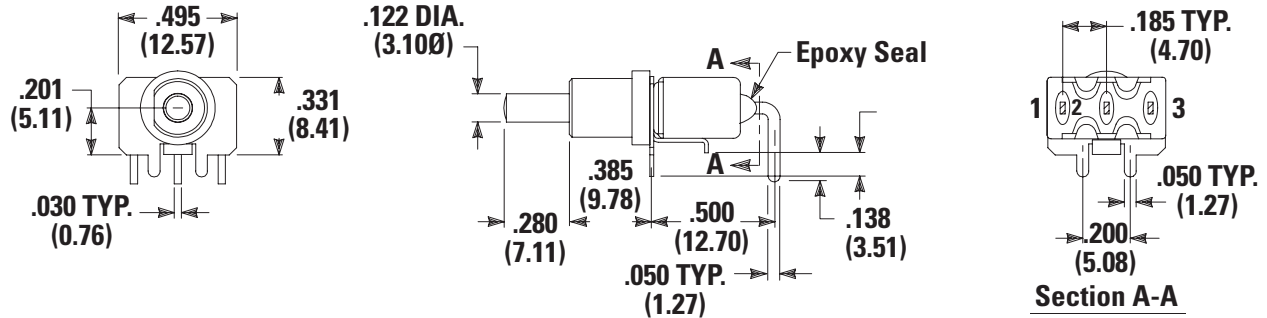

### A3 Right Angle, Snap-in, PC Thru-hole

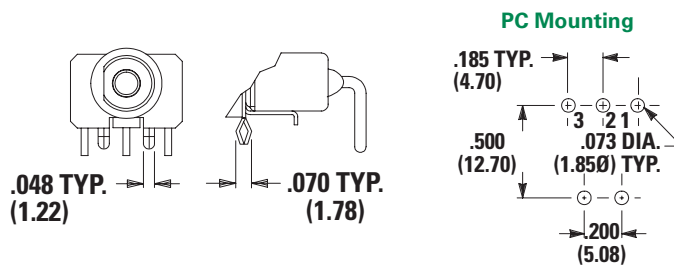

**Notes:**  
Not available with I seal. Terminal bend radii and lead-in manufacturing option. PC pattern must clear switch support leg.

### A Right Angle, PC Thru-hole

#### 8261SH9ABE2 DPDT

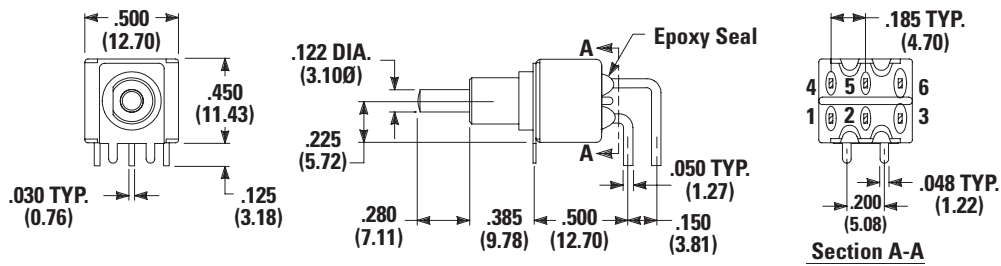

# 8060 Series

## Alternate Action and Momentary Pushbutton Switches



### A3 Right Angle, Snap-in, PC Thru-hole

#### PC Mounting

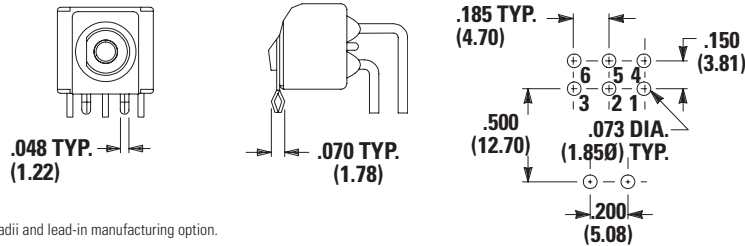

**Notes:**  
Not available with I seal. Terminal bend radii and lead-in manufacturing option.

### AV2 Vertical Right Angle, PC Thru-hole, 0.150" Pitch

#### 8161SH9AV2BE2 SPDT

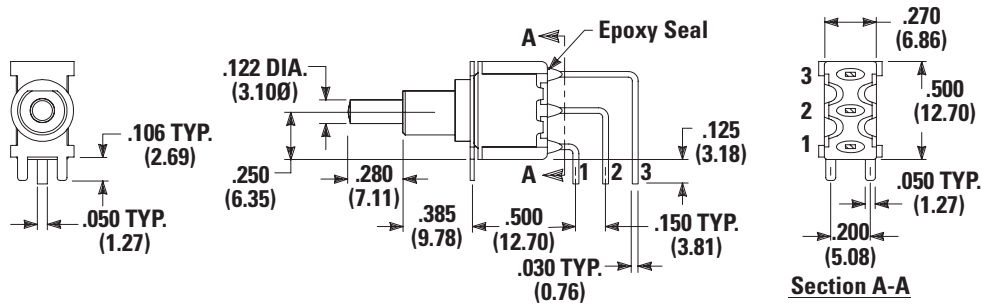

### AV3 Vertical Right Angle, Snap-in, PC Thru-hole, 0.150" Pitch

#### PC Mounting

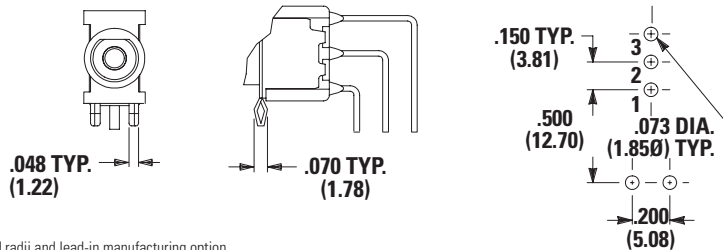

**Notes:**  
Not available with I seal. Terminal bend radii and lead-in manufacturing option.

### AV2 Vertical Right Angle, PC Thru-hole, 0.150" Pitch

#### 8261SH9AV2BE2 DPDT

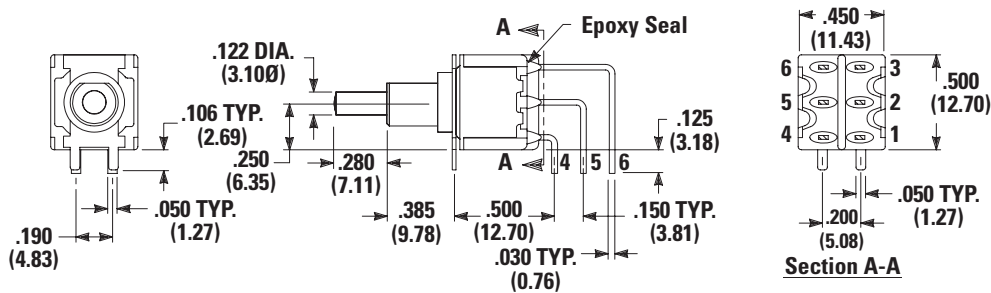

# 8060 Series

## Alternate Action and Momentary Pushbutton Switches



### AV3 Vertical Right Angle, Snap-in, PC Thru-hole, 0.150" Pitch

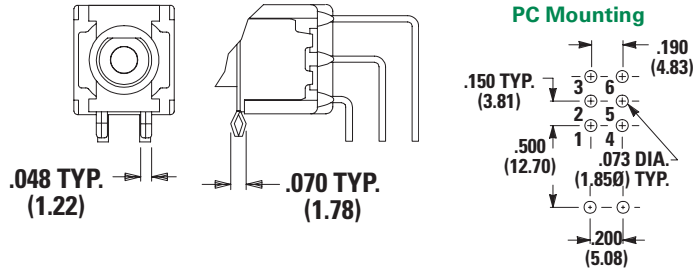

**Notes:**  
Not available with I seal. Terminal bend radii and lead-in manufacturing option.

### V6 Vertical Mount, V-Bracket V21 Vertical Mount, V-Bracket, Snap-in 8161SH9\_BE2 SPDT

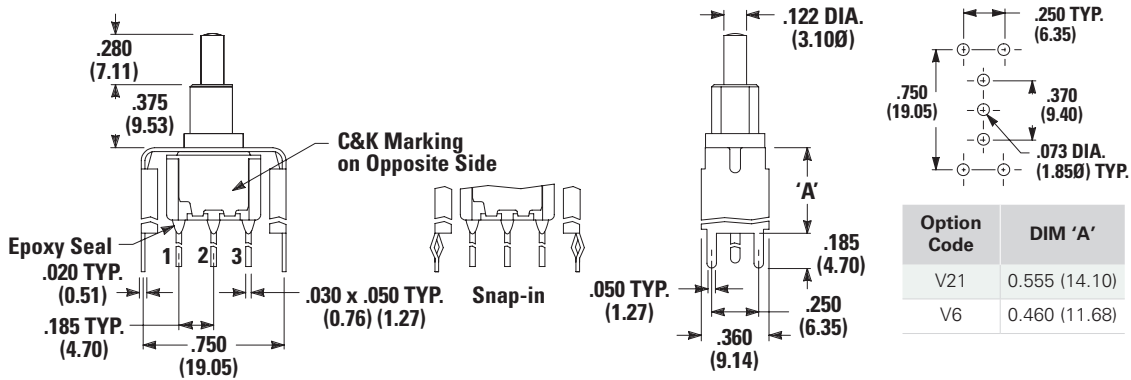

**Notes:**  
Not available with I seal.

### V6 Vertical Mount, V-Bracket V21 Vertical Mount, V-Bracket, Snap-in 8261SH9\_BE2 DPDT

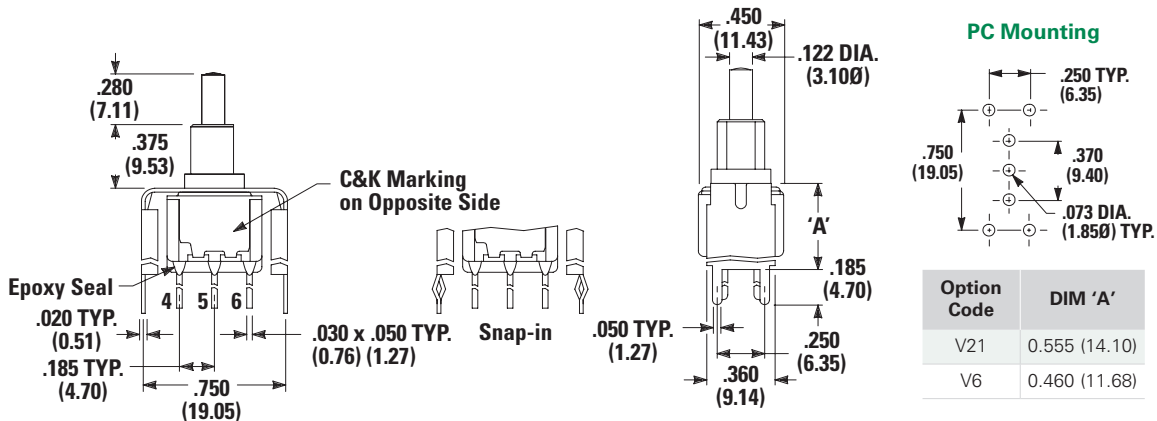

**Notes:**  
Not available with I seal.

# 8060 Series

## Alternate Action and Momentary Pushbutton Switches



### V3, V4 Vertical Mount, V-Bracket V31 Vertical Mount, V-Bracket, Snap-in

#### 8161SH9\_BE2 SPDT

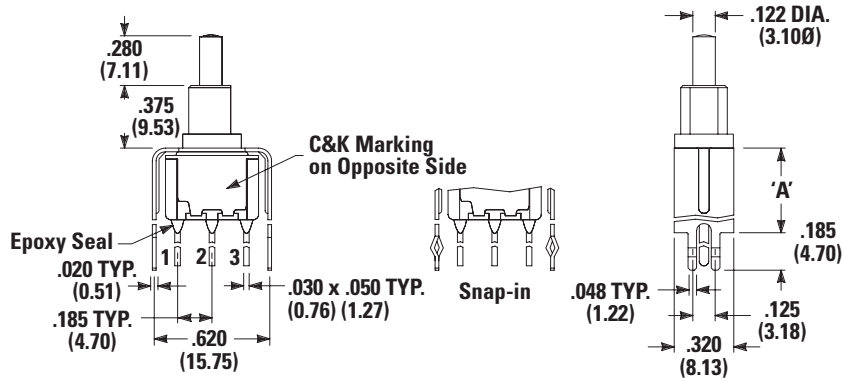

#### PC Mounting

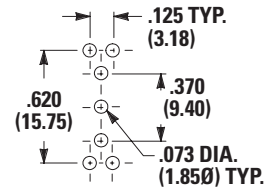

Option Code	DIM 'A'
V3, V31	0.460 (11.68)
V4	0.630 (16.00)

Notes:  
Not available with I seal.

### V3, V4 Vertical Mount, V-Bracket V31 Vertical Mount, V-Bracket, Snap-in

#### 8261SH9\_BE2 DPDT

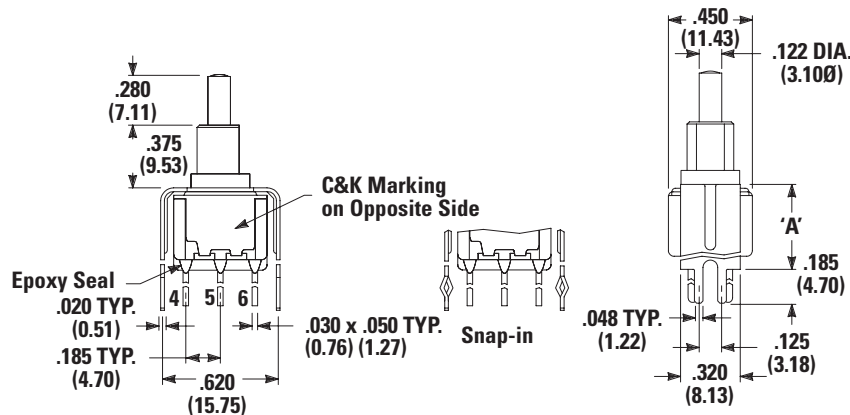

#### PC Mounting

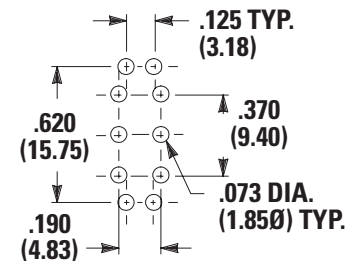

Option Code	DIM 'A'
V3, V31	0.460 (11.68)
V4	0.630 (16.00)

### Contact Material

Option Code	Contact Material	Terminal Plating	Ratings
B	Gold <sup>1</sup>	Gold <sup>1</sup>	Low Level/Dry Circuit 0.4 VA Max. @ 20 V AC or DC Max.
P		Matte-Tin <sup>6</sup>	
Q	Silver <sup>4,5</sup>	Silver <sup>5</sup>	Power 6 amps @ 120 V AC or 28 V DC; 3 AMPS @ 250 V AC
S		Matte-Tin <sup>6</sup>	
G	Gold over Silver <sup>2,3</sup>	Gold <sup>3</sup>	Low Level/Dry Circuit or Power 0.4 VA Max @ 20 V AC OR DC Max. or 1 amp @ 120 V AC or 28 V DC; 3 amps @ 250 V AC
R		Matte-Tin <sup>6</sup>	

Notes:  
See Technical Data section of this catalog for RoHS compliant and compatible definitions and specifications.

- Contacts & Terminals:** Copper alloy, with gold plate over nickel plate.
- End Contacts:** Coin silver, with gold plate over nickel plate.
- Center Contacts & All Terminals:** Copper alloy, with gold plate over nickel plate.
- End Contacts:** Coin silver, silver plated.
- Center Contact & All Terminals:** Copper alloy, silver plated.
- Terminals:** Copper alloy, with matte-tin over nickel plate.

Any models supplied with P, S, R, Q, B or G contact material are RoHS compliant. All models with all options when ordered with S, R, G, or Q contact material. B contact material standard with all terminations except C, Z & Z3. Q contact material standard with C, Z & Z3 terminations. P, S & R contact materials not available with Z & Z3 terminations.

# 8060 Series

## Alternate Action and Momentary Pushbutton Switches



### Seal

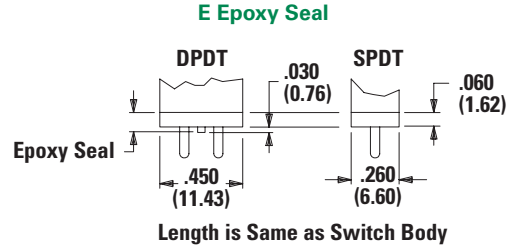
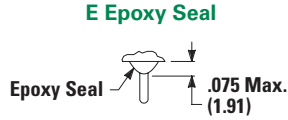

Notes:  
Available with C, W, Z, Z3 terminations only.

### Available Hardware

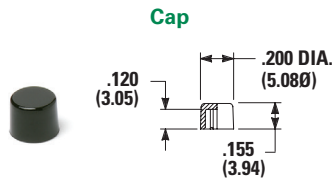

**PART NO.**  
708901000 WHITE  
708902000 BLACK  
708903000 RED  
708904000 ORANGE  
708905000 YELLOW  
708909000 GRAY  
**Material:** Nylon  
**Finish:** Gloss

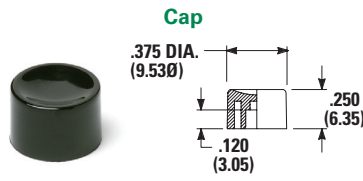

**PART NO.**  
752701000 WHITE  
752702000 BLACK  
752703000 RED  
752704000 ORANGE  
752705000 YELLOW  
752709000 GRAY  
**Material:** Nylon  
**Finish:** Gloss

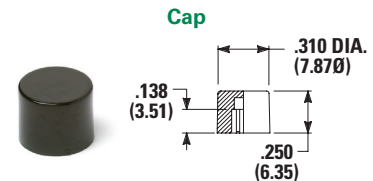

**PART NO.**  
801801000 WHITE  
801802000 BLACK  
801803000 RED  
801804000 ORANGE  
801805000 YELLOW  
801809000 GRAY  
**Material:** Nylon  
**Finish:** Gloss

### Cap, Snap Fitting Plunger

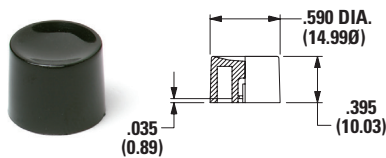

**PART NO.**  
452D01000 WHITE  
452D02000 BLACK  
452D03000 RED  
452D04000 ORANGE  
452D05000 YELLOW  
452D09000 GRAY  
**Material:** Nylon  
**Finish:** Gloss

### Cap, Snap Fitting Plunger

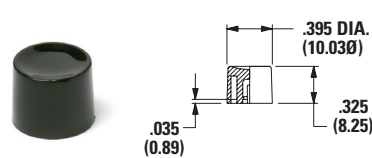

**PART NO.**  
894101000 WHITE  
894102000 BLACK  
894103000 RED  
894104000 ORANGE  
894105000 YELLOW  
894109000 GRAY  
**Material:** Nylon  
**Finish:** Gloss

### Cap, J80, J81 & J82 options only

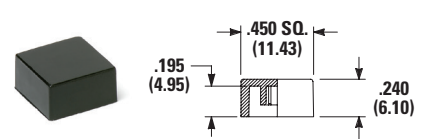

**PART NO.**  
484601000 WHITE  
484602000 BLACK  
484603000 RED  
484604000 ORANGE  
484605000 YELLOW  
484609000 GRAY  
**Material:** Nylon  
**Finish:** Gloss

**PART NO.**  
798201000 WHITE  
798202263 BLACK  
798203000 RED  
798204000 ORANGE  
798205000 YELLOW  
798209000 GRAY  
**Material:** Nylon  
**Finish:** Matte

# 8060 Series

## Alternate Action and Momentary Pushbutton Switches



Frame



**PART NO.**  
6156022263 BLACK  
**Material:** Nylon  
**Finish:** Matte

Frame



**PART NO.**  
613302263 BLACK  
**Material:** Nylon  
**Finish:** Matte

Cap, J86, J96 Options Only

**PART NO.**  
459701000  
459702000  
459703000  
459704000  
459705000  
459709000  
**Material:** Nylon  
**Finish:** Matte

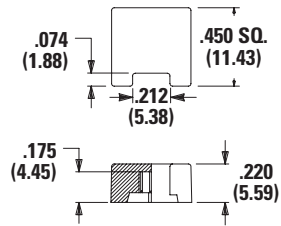

Fits Z3 Termination Female Connector

**PART NO.**  
530100000  
Available in loose pieces.



**Notes:** Additional nuts, locking rings and lockwashers available separately, see section "Technical Data and Additional Hardware". Other cap & frame colors available, consult Customer Service Center.

# 8060 Series

## Alternate Action and Momentary Pushbutton Switches



Frames snap into panel opening and are independent from switch mounting. Accurate positioning of the PC mounted switch relative to the panel opening is necessary to provide proper clearance between actuator and frame. Available in two basic styles and four panel thicknesses 0.047-0.125 in. Material: Nylon. Finish: Matte.

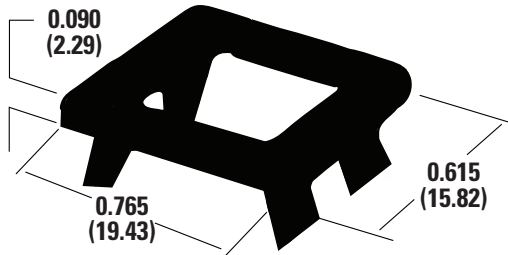

0.090" (2.29) PANEL THK.  
PART NO. 432702263

0.125" (3.18) PANEL THK.  
PART NO. 432802263  
BLACK

### Typical Application

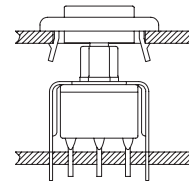

### Panel Inserts

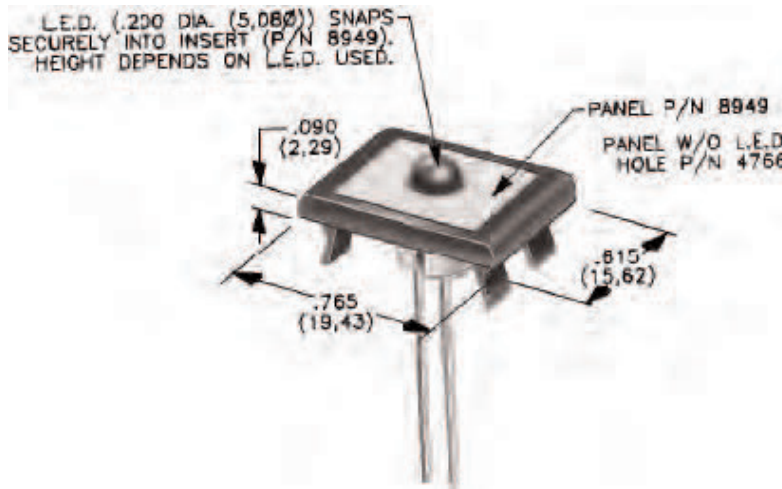

### Panel Inserts

**For Part Numbers**  
4325xxxxxx, 4326xxxxxx

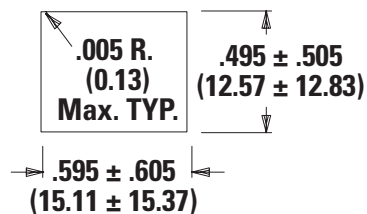

**For Part Numbers**  
4326xxxxxx, 4328xxxxxx

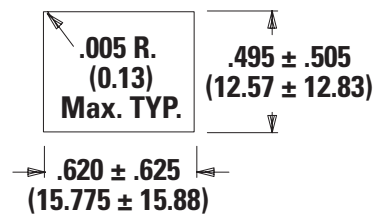

Above frames (part nos. 432XXXXXX) are also available with insert which accepts LED for indicator light assembly. Order insert separately from frame. Blank insert panel (without hole for LED) also available. LED not included.

PANEL INSERT WITH HOLE FOR LED  
PART NO. 894902000

BLANK PANEL INSERT WITHOUT HOLE FOR LED  
PART NO. 476602000 BLACK

Special colors, custom markings available, consult Customer Service Center.

# 8060 Series

## Alternate Action and Momentary Pushbutton Switches



### LED Information

Switches with LED supplied: J86 OPTIONS: Rectangular LEDs are supplied on 8060 Series pushbutton switches with J86 options. These LEDs are factory installed and are not replaceable. The following specifications apply:

Option Code	Color	Typ. Intensity	Typ. Forward Voltage	Typ. Forward Current	Max Rating at 25°C Ambient Temperature		
					Forward Voltage	Continuous Forward Current	Power Dissipation
6	Green	1.0 mcd		20 mA		50 mA	125 mW
3	Red <sup>1</sup>	0.5 mcd	2.1 V	10 mA	2.5 V	30 mA	75 mW
5	Yellow	4.0 mcd		20 mA		50 mA	125 mW

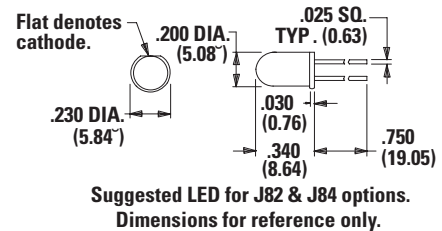

**Process Information:** Soldering to LED leads must be completed within 5 seconds at 500°F (260°C) maximum.

**Caution:** Circuit elements must limit forward current of LED to 50mA max. continuous.

1. Extra-bright red LED available (typ. intensity 4.5 mcd), consult Customer Service Center.

LEDs are not supplied with J82, J84 options. LED snaps into switch frame surrounding actuator and is wired externally.

## Looking for pricing, stock, or lifecycle information?

Click below to explore more details on WIN SOURCE:

 [View 8161J86ZQE223](#) on WIN SOURCE

 [C&K Components](#) Information

## Optimize Your Supply Chain with WIN SOURCE Solutions

-  Global Sourcing Solution
-  Obsolete Management
-  Cost Control Management
-  Shortage Management
-  Alternative Solution
-  Excess Inventory Management