

Applications

- Transient voltage protection
- High-voltage switches
- Crowbar
- Lasers
- Pulse generators

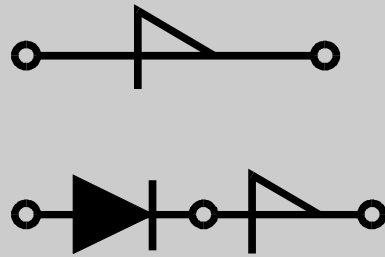

Application Note H - 6

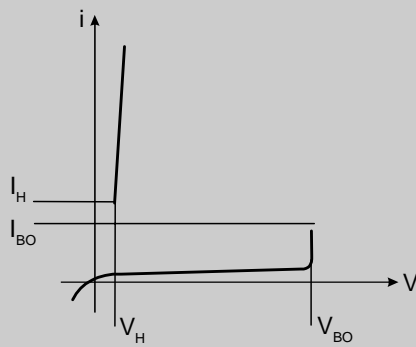
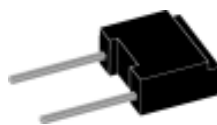

Remark: For special selection of more than 2 pieces IXBOD 1-... for every break down voltage of $V_{BO} > 2000$ V please contact us.

Single Breakover Diode

$V_{BO} = 600-1000V$
 $I_{AVM} = 0.9 A$

V_{BO} V	Standard Types
600 ±50	IXBOD 1 -06
700 ±50	IXBOD 1 -07
800 ±50	IXBOD 1 -08
900 ±50	IXBOD 1 -09
1000 ±50	IXBOD 1 -10

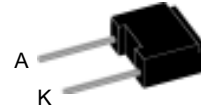

Symbol	Conditions	Rated Values
I_D	$T_{VJ} = 125^\circ C; V = 0,8x V_{BO}$	20 μA
V_{BO}	$V_{BO}(T_{VJ}) = V_{BO, 25^\circ C} [1 + K_T (T_{VJ} - 25^\circ C)]$	
I_{RMS}	$f = 50 \text{ HZ}; T_{amb} = 50^\circ C$ connection pins soldered to printed circuit (conductor 0,035x2mm)	1.4 A
I_{AVM}		0.9 A
I_{SM}	$t_p = 0.1 \text{ ms}; T_{amb} = 50^\circ C$ non repetitive	200 A
I^2t	$t_p = 0.1 \text{ ms}; T_{amb} = 50^\circ C$	2 A^2s
T_{amb}		-40...+125 $^\circ C$
T_{stg}		-40...+125 $^\circ C$
T_{VJm}		125 $^\circ C$
K_T	Temperatur coefficient of V_{BO}	$2 \cdot 10^{-3} K^{-1}$
K_p	coefficient for energy per pulse E_p (material constant)	700 K/Ws
R_{thJA}	- natural convection - with air speed 2 m/s	60 K/W 45 K/W
Weight		1 g

Symbol	Conditions	Characteristic Values
I_{BO}	$T_{VJ} = 25^\circ C$	15 mA
I_H	$T_{VJ} = 25^\circ C$	30 mA
V_H	$T_{VJ} = 25^\circ C$	4 - 8 V
$(dv/dt)_c$	$T_{VJ} = 50^\circ C; V_D = 0.67 \cdot (V_{BO} + 100V)$	> 1000 $V/\mu s$
$(di/dt)_c$	$T_{VJ} = 125^\circ C; V_D = V_{BO}; I_T = 80A; f = 50 \text{ Hz}$	200 $A/\mu s$
$t_{q(typ)}$	$T_{VJ} = 125^\circ C; V_D = 0.67 \cdot V_{BO}; V_R = 0V$ $dV/dt_{(lin.)} = 200V/\mu s; I_T = 80A; di/dt = -10A/\mu s$	150 μs
V_T	$T_{VJ} = 125^\circ C; I_T = 5A$	1.7 V
$V_{(TO)}$	For power-loss calculations only	1.1 V
r_T	$T_{VJ} = 125^\circ C$	0.12 Ω

Dimensions in mm (1 mm = 0.0394")

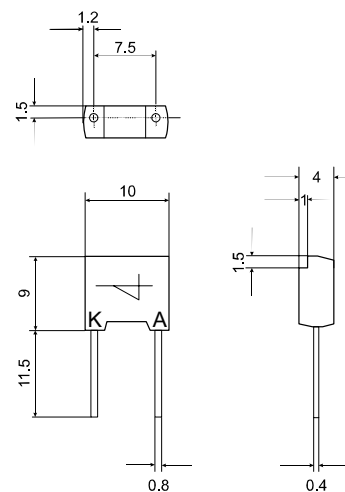

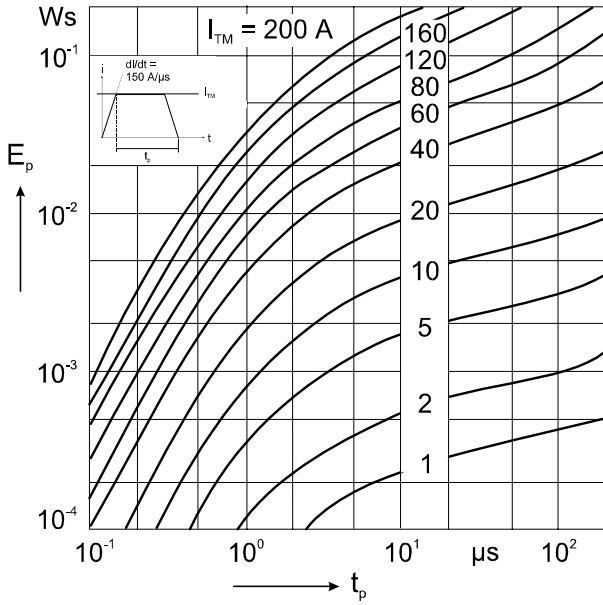

Fig. 1 Energy per pulse for trapezoidal current waveforms (see waveform definition).

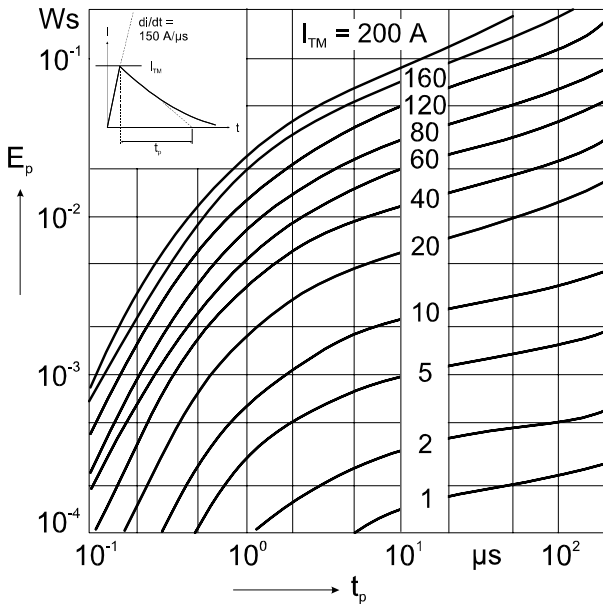

Fig. 2 Energy per pulse for exponentially decaying current pulse (see waveform definition).

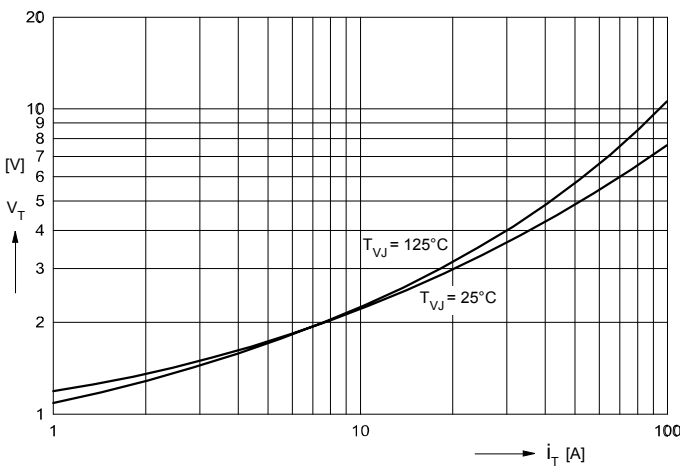

Fig. 3 On-state voltage

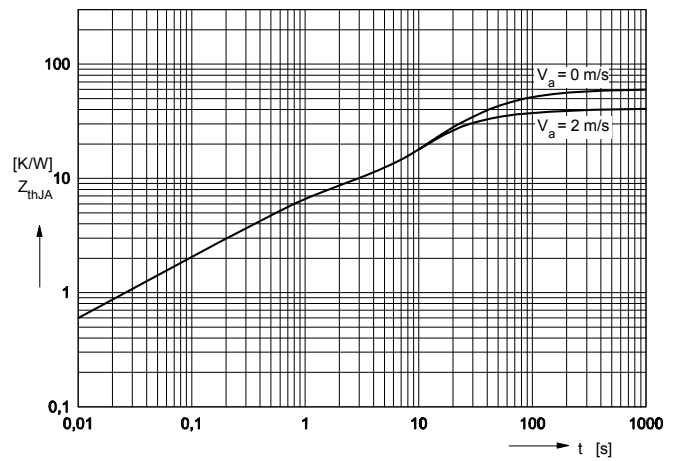

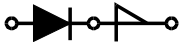

Fig. 4 Transient thermal resistance.

Breakover Diode Modules

Version: R 

Version: RD 

V_{BO} V	Standard Types	BOD - Elements	V_{BO} V	Standard Types	BOD - Elements	V_{BO} V	Standard Types	BOD - Elements
1200 ±50	IXBOD 1 -12R(D)	2	2000 ±50	IXBOD 1 -20R(D)	3	3400 ±100	IXBOD 1 -34R	4
1300 ±50	IXBOD 1 -13R(D)	2	2100 ±50	IXBOD 1 -21R(D)	3	3600 ±100	IXBOD 1 -36R	4
1400 ±50	IXBOD 1 -14R(D)	2	2200 ±50	IXBOD 1 -22R(D)	3	3800 ±100	IXBOD 1 -38R	4
1500 ±50	IXBOD 1 -15R(D)	2	2300 ±50	IXBOD 1 -23R(D)	3	4000 ±100	IXBOD 1 -40R	4
1600 ±50	IXBOD 1 -16R(D)	2	2400 ±50	IXBOD 1 -24R(D)	3	4200 ±100	IXBOD 1 -42R	4
1700 ±50	IXBOD 1 -17R(D)	2	2500 ±50	IXBOD 1 -25R(D)	3			
1800 ±50	IXBOD 1 -18R(D)	2	2600 ±100	IXBOD 1 -26R(D)	3			
1900 ±50	IXBOD 1 -19R(D)	2	2800 ±100	IXBOD 1 -28R(D)	3			
			3000 ±100	IXBOD 1 -30R(D)	3			
			3200 ±100	IXBOD 1 -32R(D)	3			

Symbol	Test Conditions	2 BODs	3 BODs	4 BODs	2-3 BODs D-Version	
I_D	$T_{VJ} = 125^\circ\text{C}; V = 0,8x V_{BO}$	100	100	100	100	μA
V_{BO}						$V_{BO}(T_{VJ}) = V_{BO, 25^\circ\text{C}} [1 + K_T (T_{VJ} - 25^\circ\text{C})]$
I_{RMS}	$f = 50 \text{ Hz}; T_{amb} = 50^\circ\text{C}$ connection pins soldered to printed circuit (conductor 0,035x2mm)	2.0	1.4	1.1	0.3	A
I_{AVM}		1.25	0.9	0.7	0.2	A
I_{SM}	$t_p = 0.1 \text{ ms}; T_{amb} = 50^\circ\text{C}$ non repetitive	200	200	200	50	A
I^2t	$t_p = 0.1 \text{ ms}; T_{amb} = 50^\circ\text{C}$	2	2	2	0.125	A^2s
V_T	$T_{VJ} = 125^\circ\text{C}; I_T = 5\text{A}$	3.4	5.1	6.8	27	V
$V_{(TO)}$	For power-loss calculations only	2.2	3.3	4.4	17.5	V
r_T	$T_{VJ} = 125^\circ\text{C}$	0.24	0.36	0.48	3	Ω
T_{amb}		-40...+125	-40...+125	-40...+125	-40...+125	$^\circ\text{C}$
T_{stg}		-40...+125	-40...+125	-40...+125	-40...+125	$^\circ\text{C}$
T_{VJm}		125	125	125	125	$^\circ\text{C}$
K_T	Temperatur coefficient of V_{BO}	$2 \cdot 10^{-3}$	$2 \cdot 10^{-3}$	$2 \cdot 10^{-3}$	$2 \cdot 10^{-3}$	K^{-1}
K_p	coefficient for energy per pulse E_p (material constant)	700	700	700	700	K/Ws
R_{thJA}	- natural convection - with air speed 2 m/s	20 16	20 16	20 16	20 16	K/W K/W
Weight	typical	14	14	14	14	g

Symbol	Test Conditions	Characteristic Values <u>both</u> Versions R & RD	2 BODs	3 BODs	4 BODs	
I_{BO}	$T_{VJ} = 25^\circ\text{C}$		15	15	15	mA
I_H	$T_{VJ} = 25^\circ\text{C}$		30	30	30	mA
V_H	$T_{VJ} = 25^\circ\text{C}$		4 - 8	4 - 8	4 - 8	V
$(dv/dt)_C$	$T_{VJ} = 50^\circ\text{C}; V_D = 0.67 \cdot (V_{BO} + 100\text{V})$ - V_{BO} bis 1500V - V_{BO} 1600 - 2000V - V_{BO} 2100 - 2500V - V_{BO} 2600 - 3000V - V_{BO} 3200 - 3400V - V_{BO} 3600 - 4200V		> 1000 > 1500 - - - -	- - > 2000 > 2500 - -	- - - - > 3000 > 3500	$\text{V}/\mu\text{s}$ $\text{V}/\mu\text{s}$ $\text{V}/\mu\text{s}$ $\text{V}/\mu\text{s}$ $\text{V}/\mu\text{s}$ $\text{V}/\mu\text{s}$
$(di/dt)_C$	$T_{VJ} = 125^\circ\text{C}; V_D = V_{BO}; I_T = 80\text{A}; f = 50 \text{ Hz}$		200	200	200	$\text{A}/\mu\text{s}$
$t_{q(\text{typ})}$	$T_{VJ} = 125^\circ\text{C}$ $dv/dt_{(\text{lin.})} = 200\text{V}/\mu\text{s}; I_T = 80\text{A}; di/dt = -10\text{A}/\mu\text{s}$		150	150	150	μs

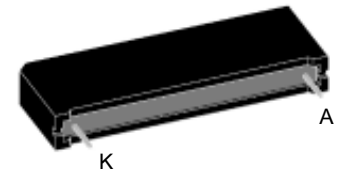
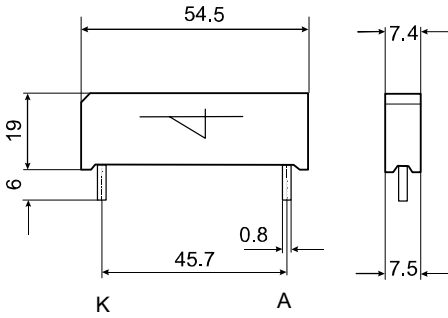

Dimensions in mm (1 mm = 0.0394")

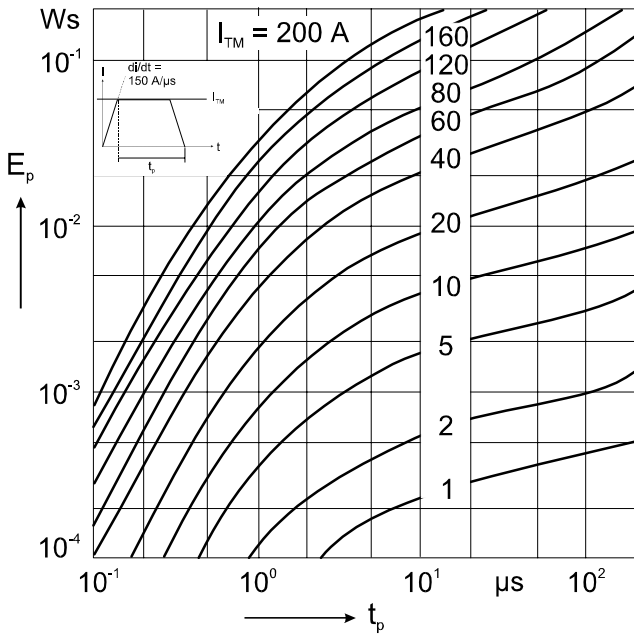

Fig. 5 Energy per pulse for single BOD element for trapezoidal wave current. E_p must be multiplied by number of elements for total energy.

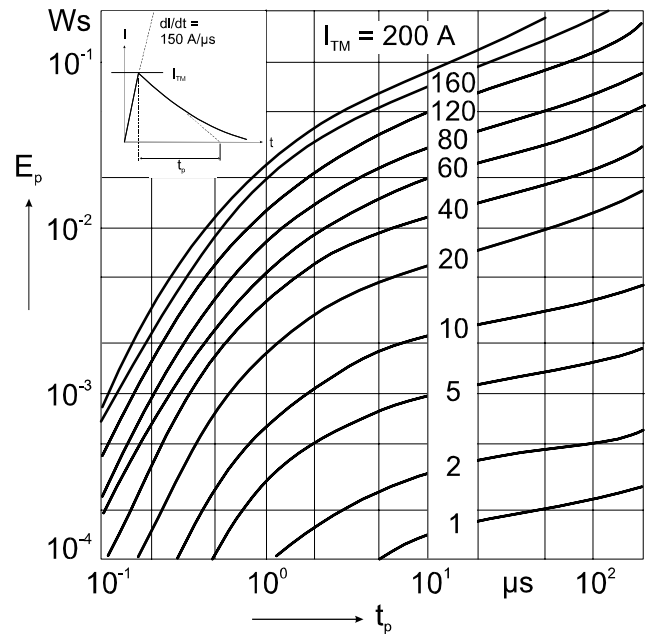

Fig. 6 Energy per pulse for single BOD element for exponentially decaying current pulse. E_p must be multiplied by number of elements for total energy.

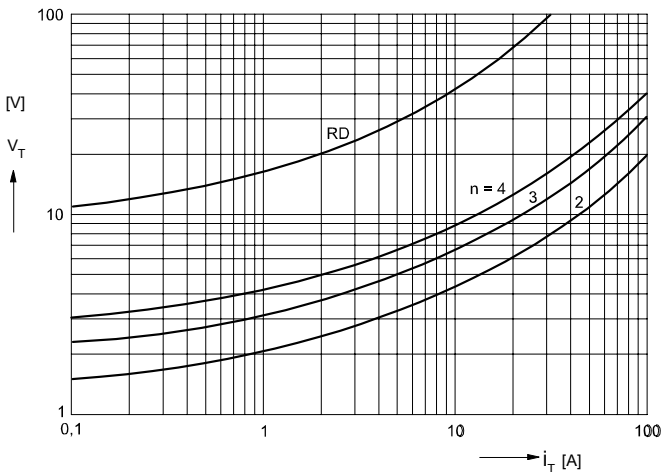

Fig. 7 On-state voltage at $T_{VJ} = 125^\circ\text{C}$.

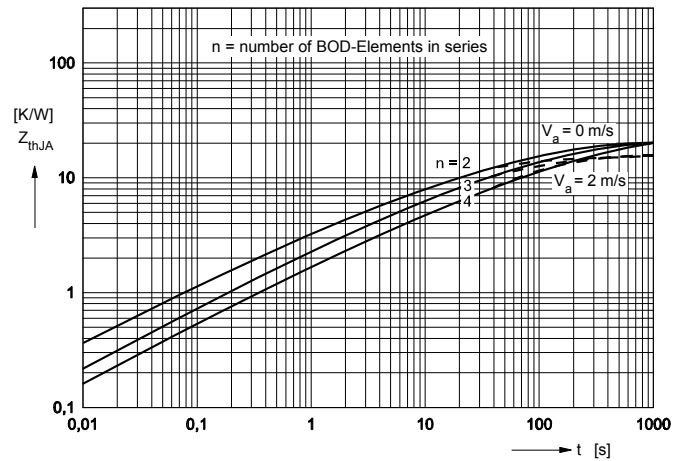
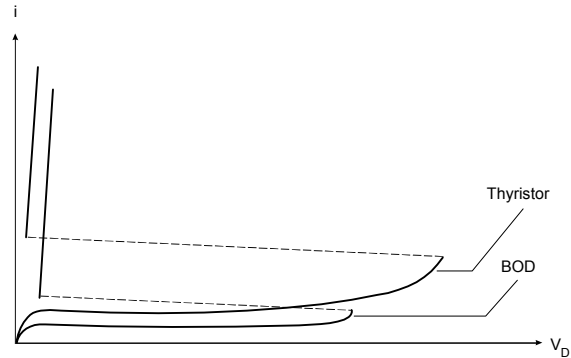

Fig. 8 Transient thermal resistance.

Application

Protection of thyristors against overvoltages in forward direction.

$$V_{BO}(T_{VJ}) = V_{BO, 25^{\circ}C} [1 + KT(T_{VJ} - 25^{\circ}C)]$$



Calculation example

a. The maximum junction temperature shall be calculated for a module IXBOD 1 -30R at an ambient temperature $T_a = 60^{\circ}C$, an exponentially decaying current $I_{TM} = 40A$, a pulsewidth $t_p = 2 \mu s$, an operating frequency $f = 50 \text{ Hz}$ and natural convection. From the diagram Fig. 6 the energy per pulse is obtained:

$$E_{p1} = 6 \times 10^{-3} \text{ Ws}$$

For a module IXBOD1-30R the number of single IXBOD elements is:

$$n = 3$$

At natural air cooling the thermal resistance junction to ambient amounts to (Fig.8):

$$R_{thJA} = 20K/W$$

and the unknown temperature can be calculated as:

$$T_{VJmax1} = T_a + n \cdot f \cdot E_p \cdot R_{thJA} + K_p \cdot E_p$$

$$T_{VJmax1} = 60 + 18 + 4.2 = 82.2^{\circ}C$$

b. If following these steady-state conditions an overload for 1 minute occurs with $I_{TM} = 60 \text{ A}$ and a pulse-width $t_p = 4 \mu s$ at the same operating frequency $f = 50 \text{ Hz}$, then the resulting maximum junction temperature is calculating as follows:

$$T_{VJmax2} = T_{VJmax1} + (E_{p2} - E_{p1}) \cdot n \cdot f \cdot Z_{thJA}(t) + K_p \cdot (E_{p2} - E_{p1})$$

The diagrams Fig. 11 and Fig. 8 show

$$E_{p2} = 14 \times 10^{-3} \text{ Ws}$$

$$Z_{thJA}(t = 1\text{min}) = 12K/W$$

From what follows:

$$T_{VJmax2} = 82.2 + 14.4 + 5.6 = 102.2^{\circ}C$$

which is allowed because the maximum admissible junction temperature $T_{VJM} = 125^{\circ}C$.

Example of a circuit

A simple emergency triggering circuit.

- T : Thyristor
- R_1 : Current limiting resistance (0 - 200 Ω)
- D_1 : Series-diode (fast recovery diode)
- D_3 : Protection diode
- D_4 : Zener diode, typical V_Z : 3-6 V
- R_2, C_2 : Protection against parasitic triggering;
recommended values:
 R_2 : 100 - 1000 Ω
 C_2 : 22 - 47 nF
- R_3, C_3 : Snubber network of the thyristor

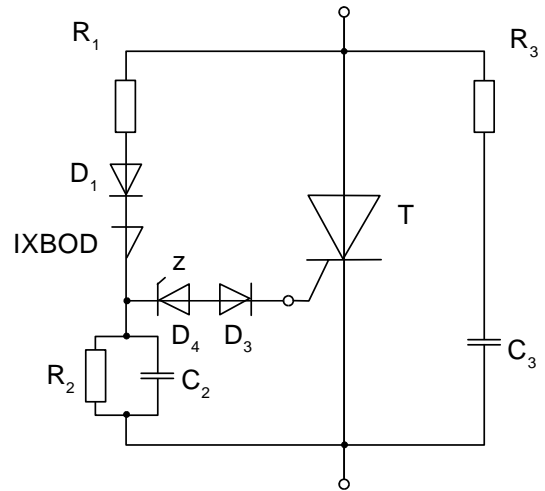

Notice

1. A IXBOD element has a maximum reverse blocking voltage of 10V.
2. For higher reverse voltages a fast, soft recovery diode must be connected in series (Fig. 9). This diode must fulfill the conditions of Fig. 10.

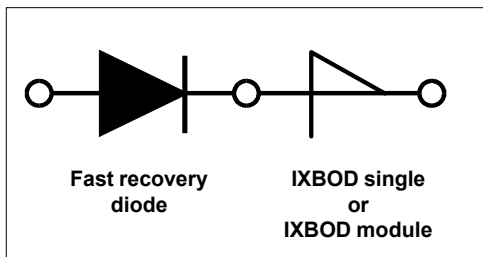

Fig. 9 IXBOD protection by a fast recovery diode.

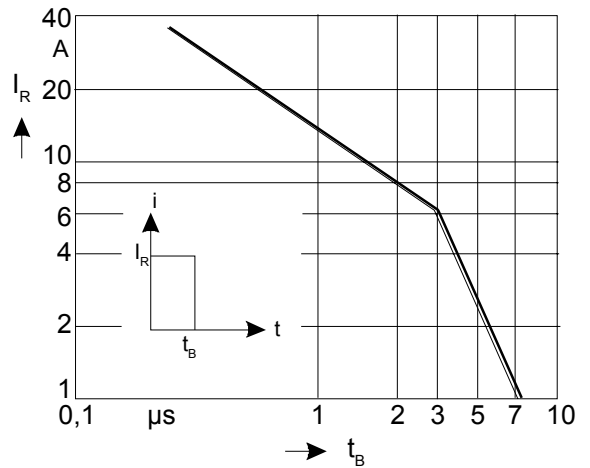

Fig. 10 Maximum peak value of the reverse current admissible for a given pulse-width t_B , which is required for the suitable fast recovery series-diode.

Looking for pricing, stock, or lifecycle information?

Click below to explore more details on WIN SOURCE:

 [View IXBOD1-20R on WIN SOURCE](#)

 [IXYS Information](#)

Optimize Your Supply Chain with WIN SOURCE Solutions

-  Global Sourcing Solution
-  Obsolete Management
-  Cost Control Management
-  Shortage Management
-  Alternative Solution
-  Excess Inventory Management