

SPECIFICATION

- Part No. : **TI.15.3113**
- Product Name : 433MHz ISM Band Dipole Antenna
- Feature : SMA(M) Connector
Hinge design for optimal reception
RoHS Compliant



I. Introduction

TI.15 series is high performance 433MHz Omni-directional dipole antenna. This SMA plug mount antenna is ideal for general purpose use. The hinge design enables the antenna to be positioned at the optimal reception angle.

II. Specification

ELECTRICAL	
Centre Frequency	433.05~434.79MHz
Average Gain	-9.0dBi
Peak Gain	-4.7dBi
Efficiency	12%
VSWR	1.5 : 1 max
Polarization	Linear
Impedance	50 Ω
MECHANICAL	
Dimensions	198 x φ 13 mm
Housing Material	ABS + PC
Connector	SMA(M)
Weight	21g
ENVIRONMENTAL	
Operation Temperature	-40°C to 85°C
Storage Temperature	-40°C to 105°C
Relative Humidity	40% to 95%

* Electrical properties are measured with the antenna in bend position in free space.

III. Antenna S11 Property

III.1. Bend Position Return Loss

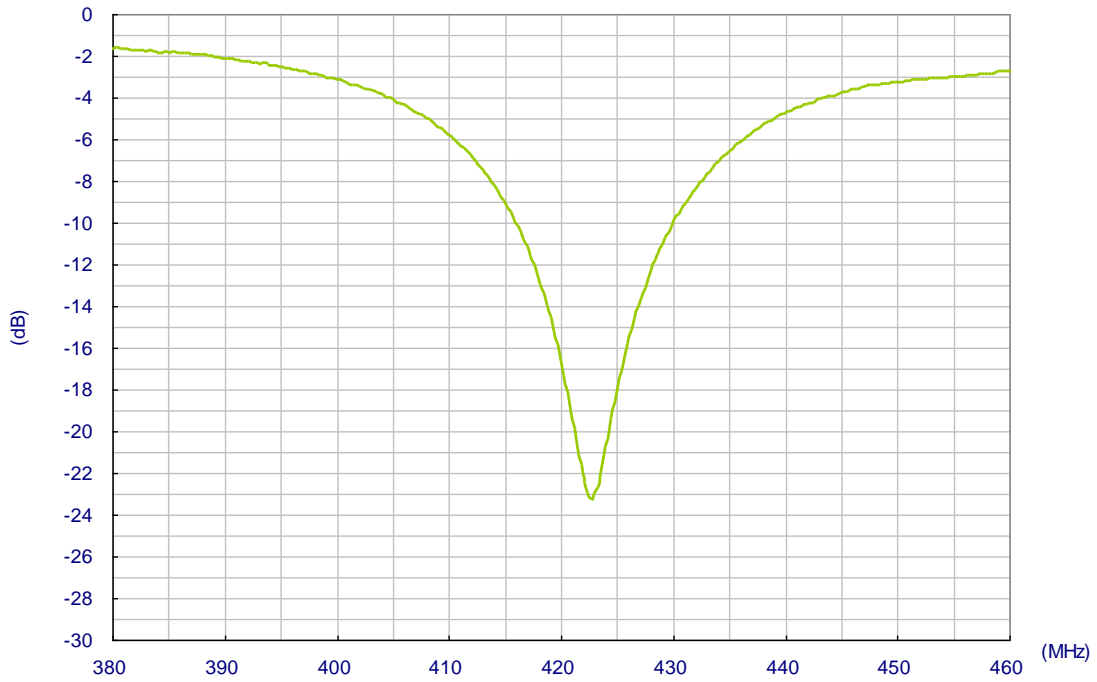

III.2. 180 Degree Straight Position Return Loss

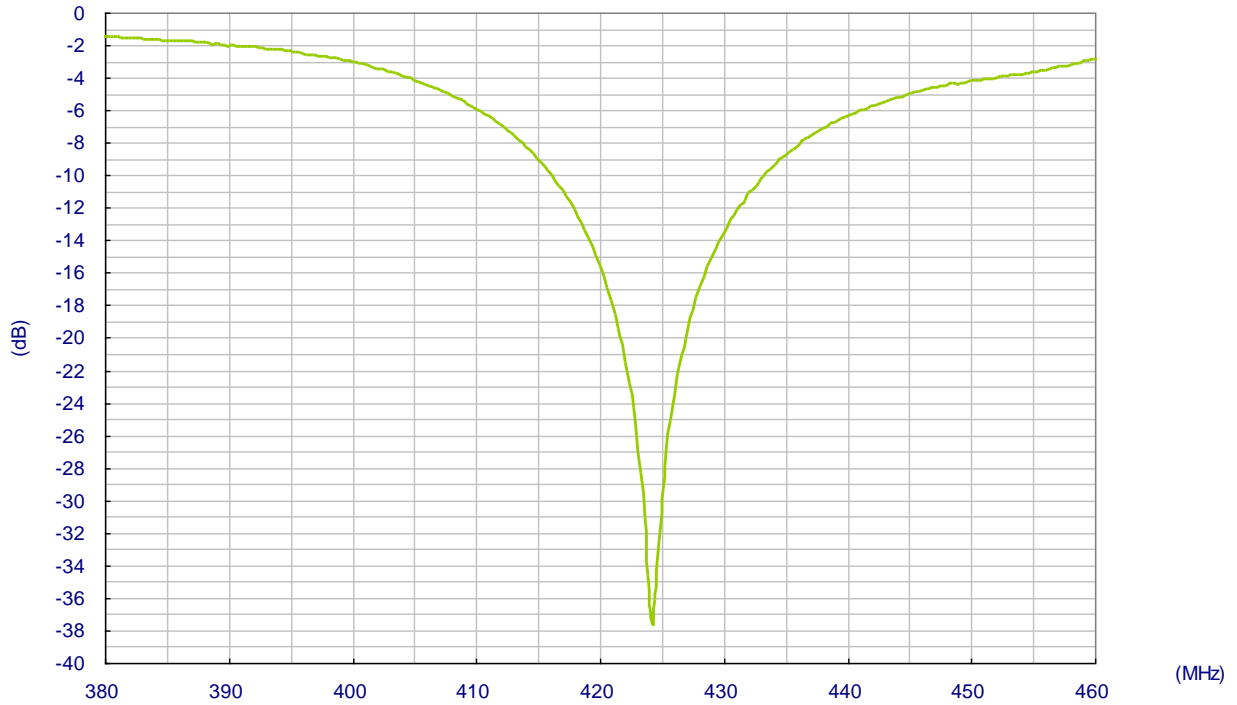

III.3. Bend Position VSWR

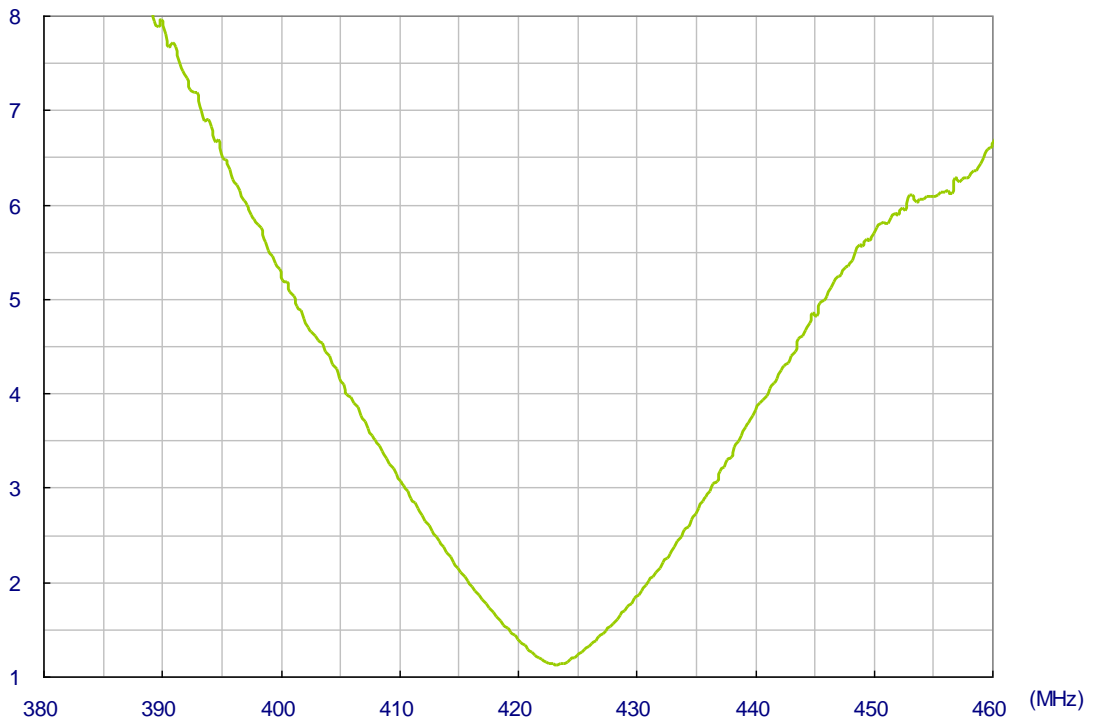

III.4. Straight Position VSWR

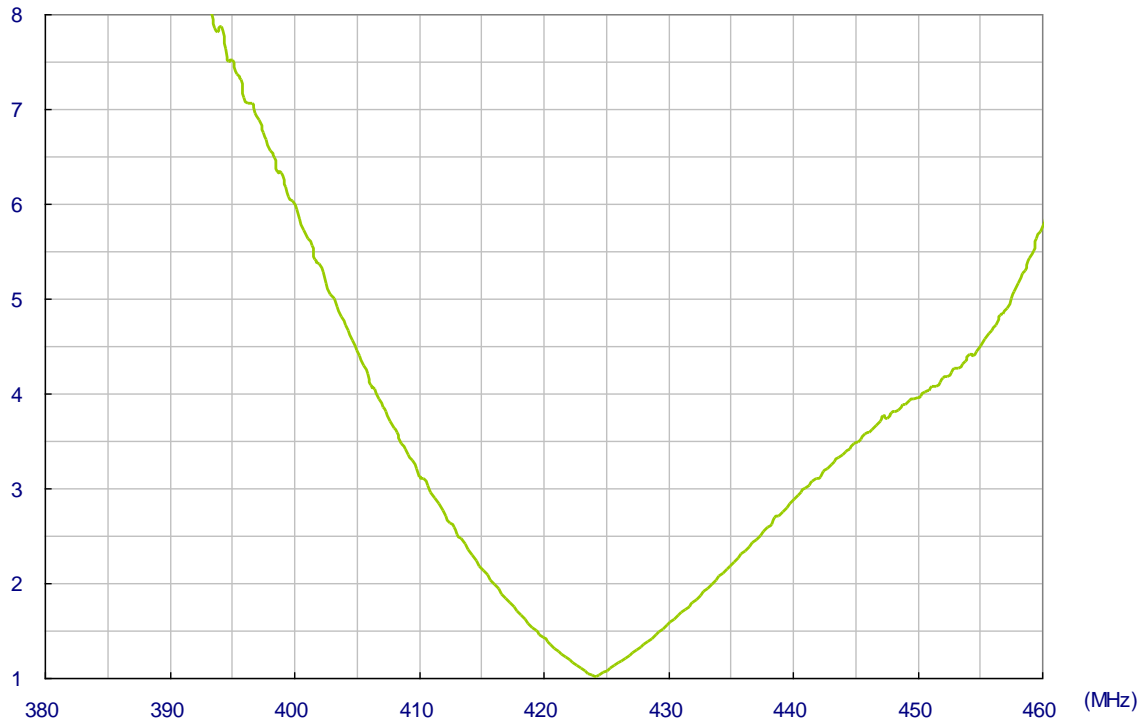

IV. Antenna Radiation Property

IV.1. Bend Position Radiation Efficiency

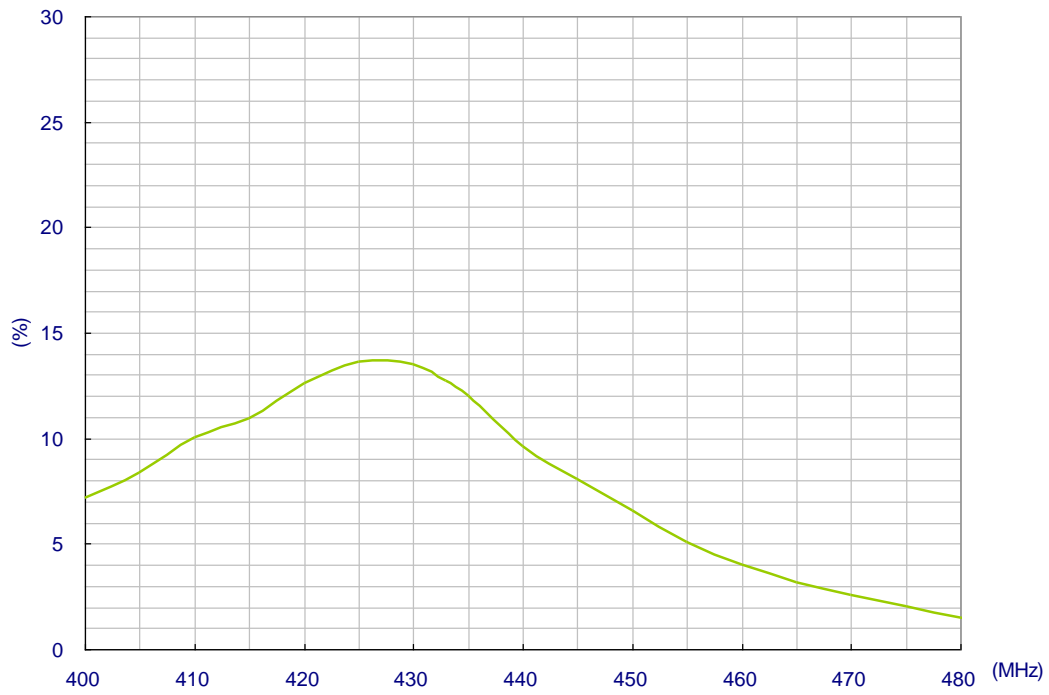

IV.2. Straight Position Radiation Efficiency

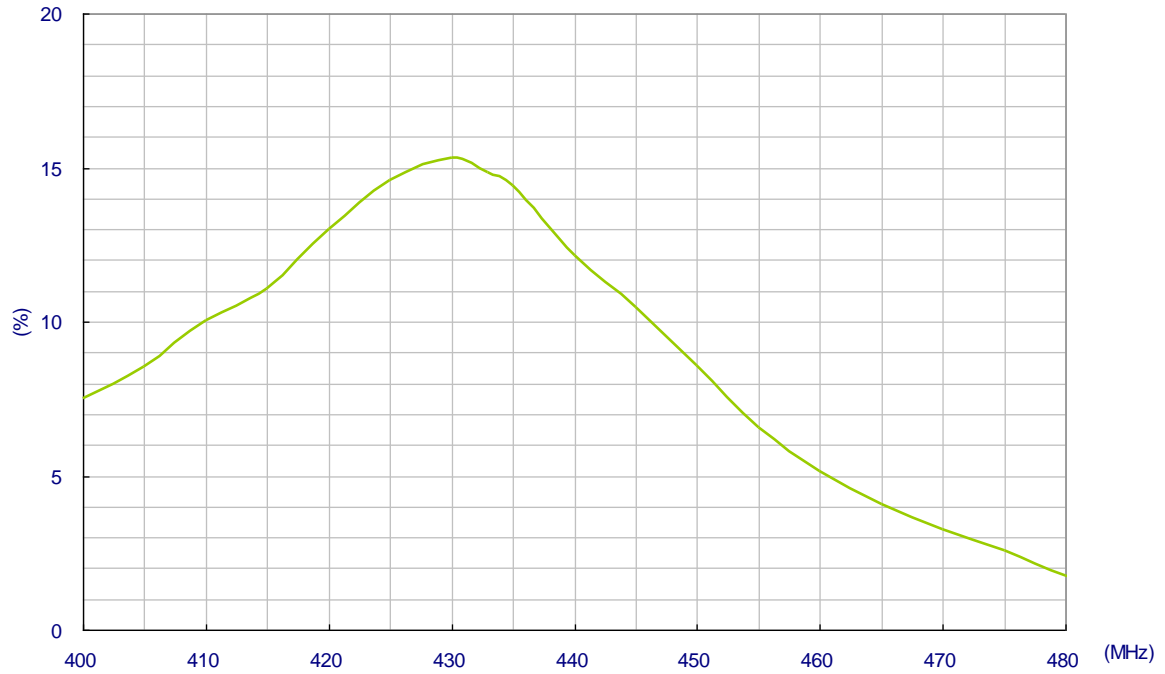

IV.3. Bend Position Peak Gain

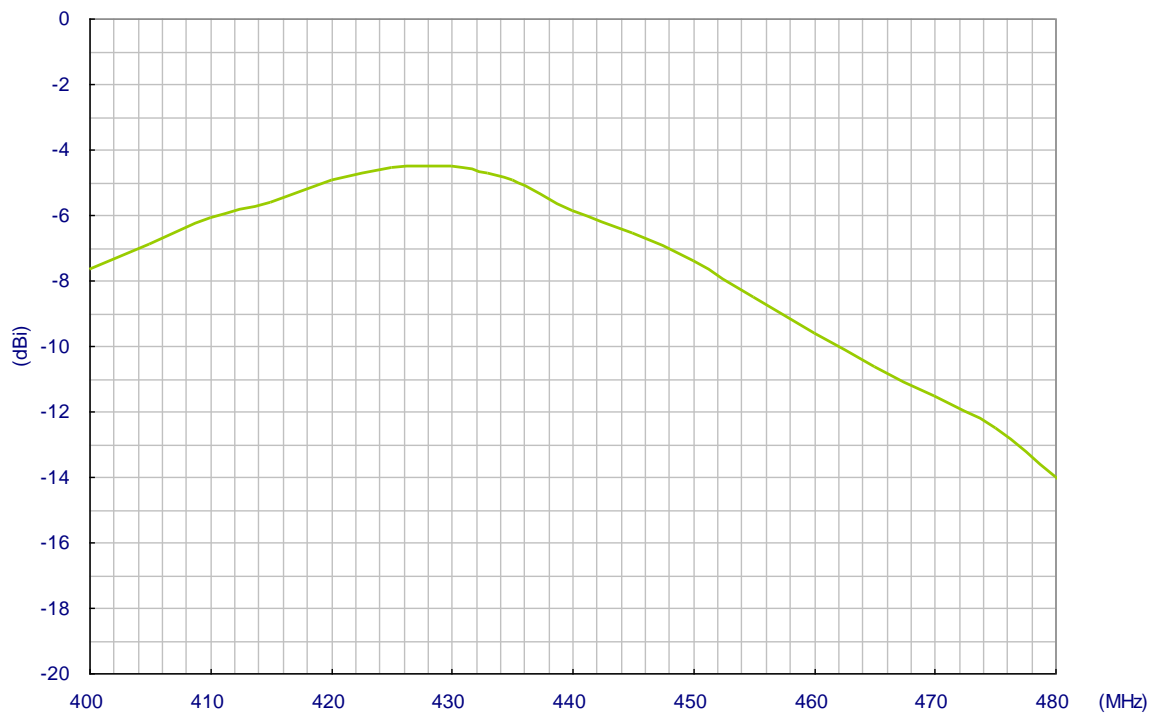

IV.4. Straight Position Peak Gain

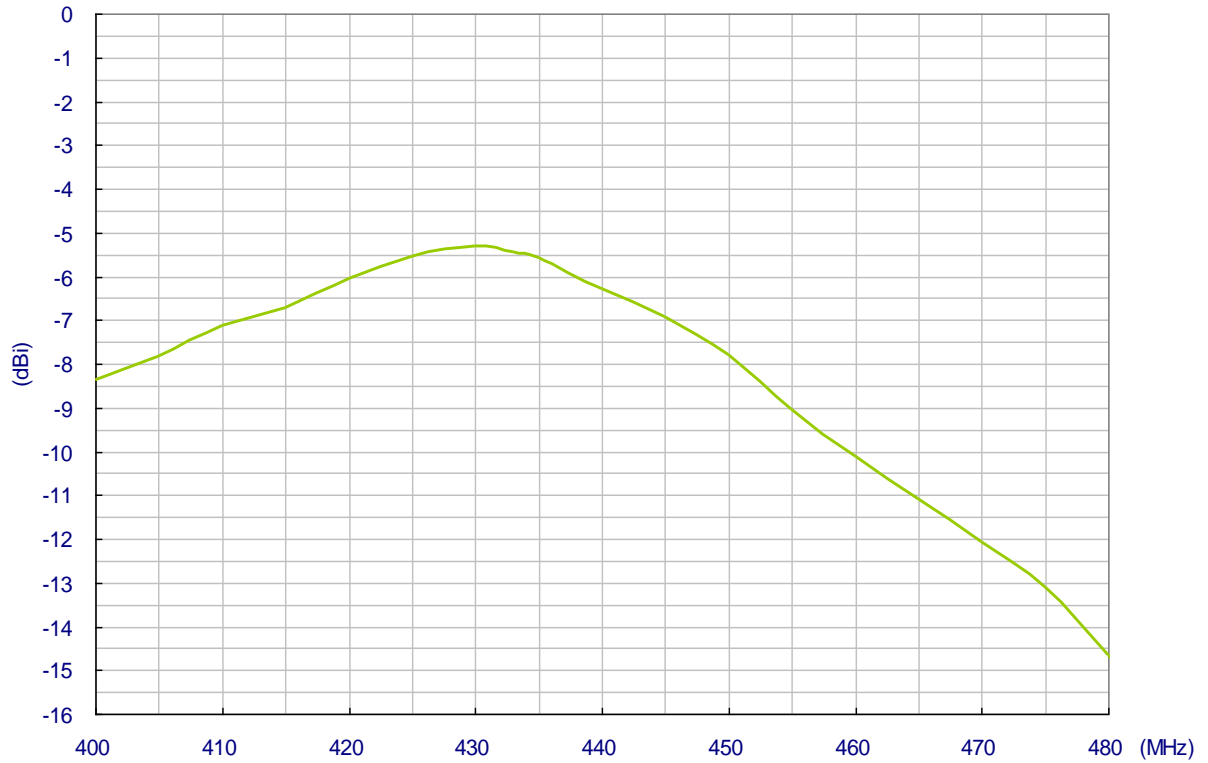

IV.5. Bend Position Average Gain

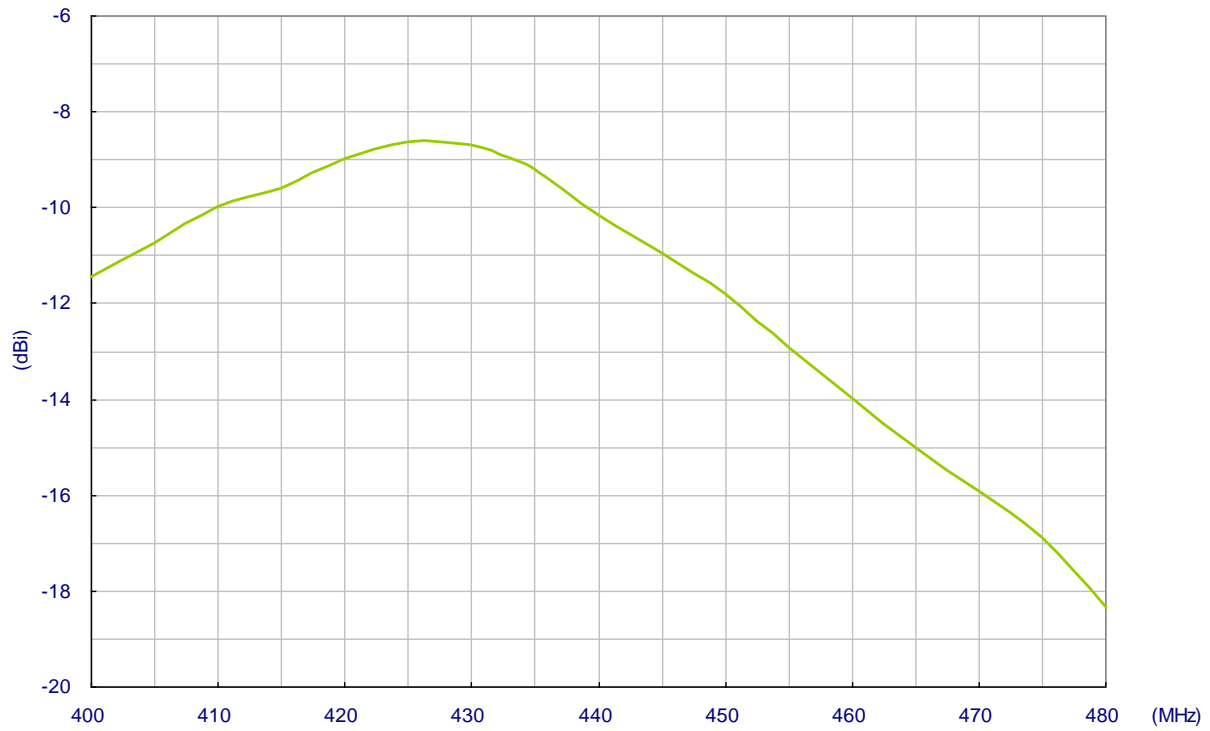

IV.6. Straight Position Average Gain

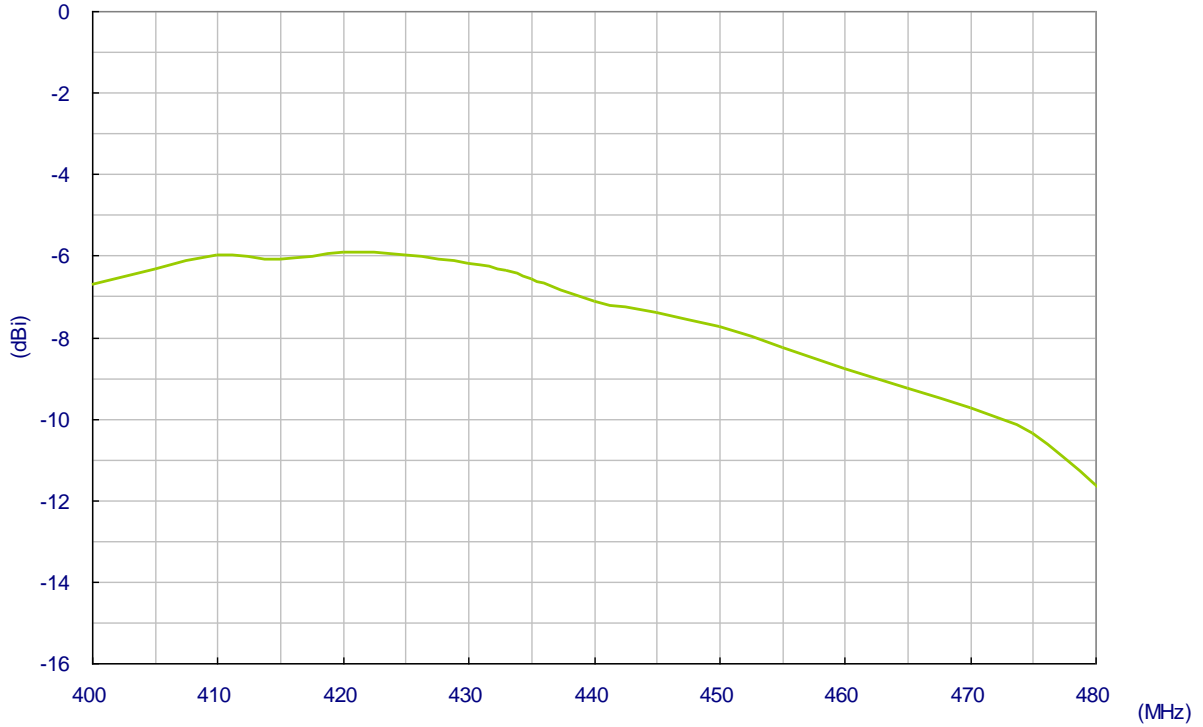

IV.7. 433MHz Bend Position Radiation Pattern

H-plane Radiation

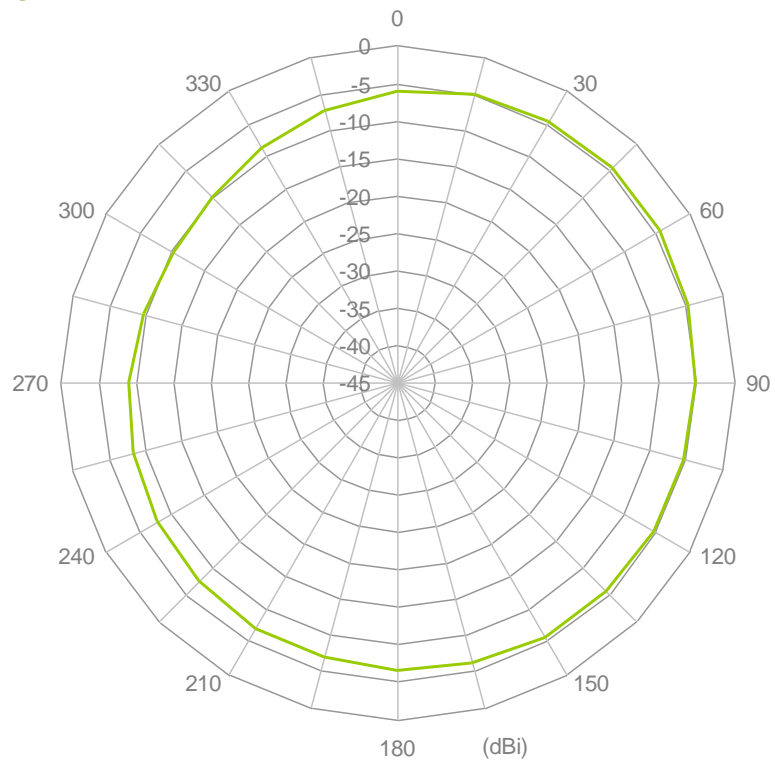

E-plane Radiation

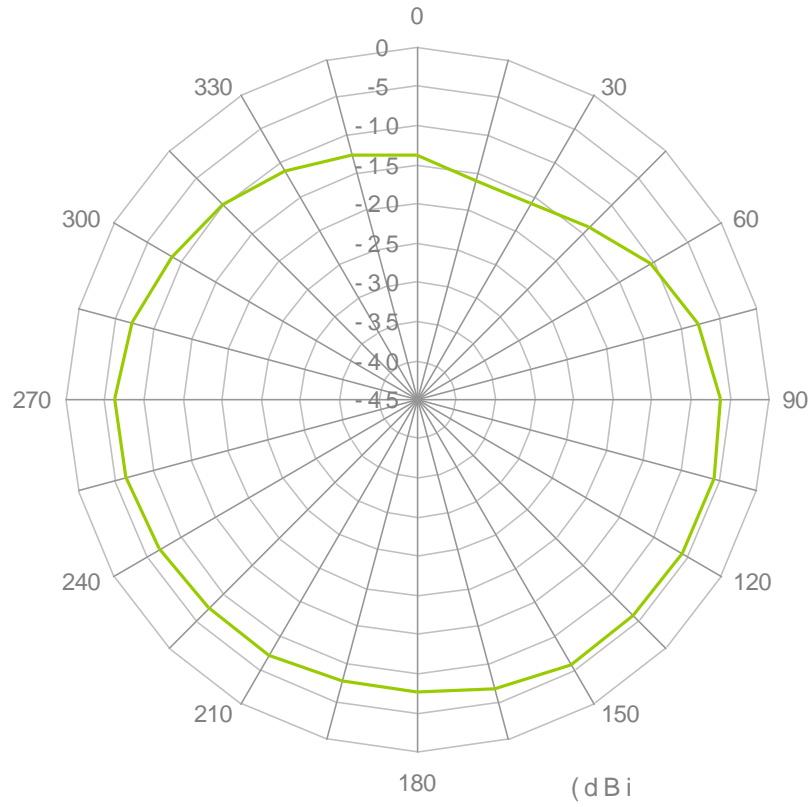

IV.8. 433MHz Straight Position Radiation Pattern

H-plane Radiation

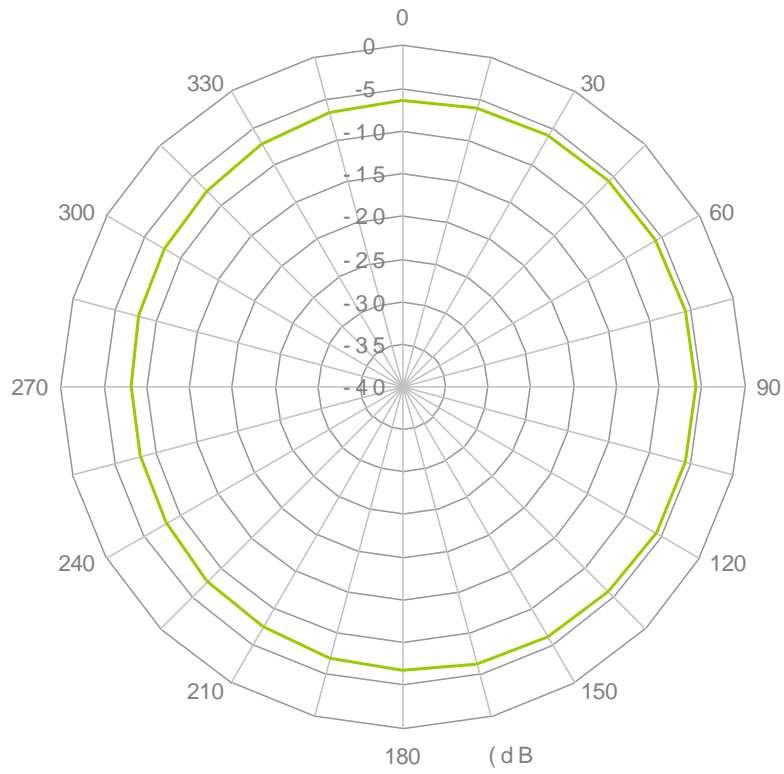

E-plane Radiation

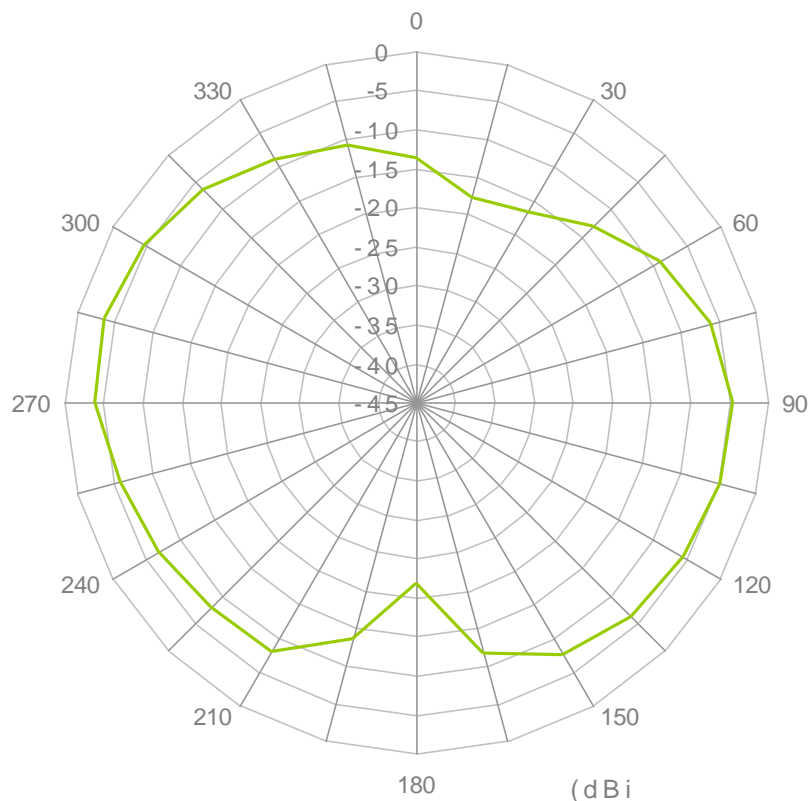

V. Ground Plane Effect

TI.15 may be mounted near a piece of ground plane. The ground plane changes the antenna radiation property. We have placed TI.15 in different near-ground scenarios and observe its radiation behaviors. Four different antenna placements were tested --

1. Free Space
2. Small Ground (15 x 9cm) – common size of CPE devices. TI.15 is mounted at the longer edge for testing.
3. Big Ground Edge (45 x 30cm) – simulate the effect of mounting antenna on a base station device. TI.15 is mounted at the centre of the longer edge.
4. Big Ground Centre (45 x 30cm) – simulate the effect of mounting antenna in a centre of a big ground plane, such as vehicle top.

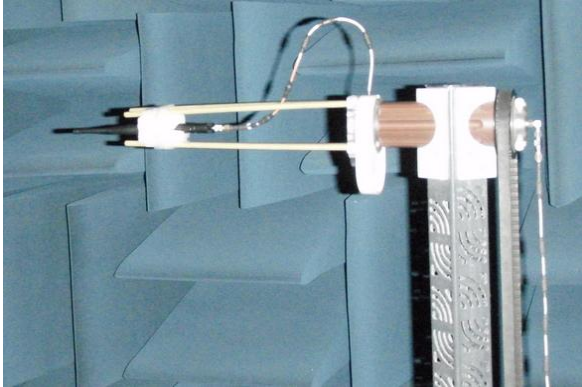

Free space

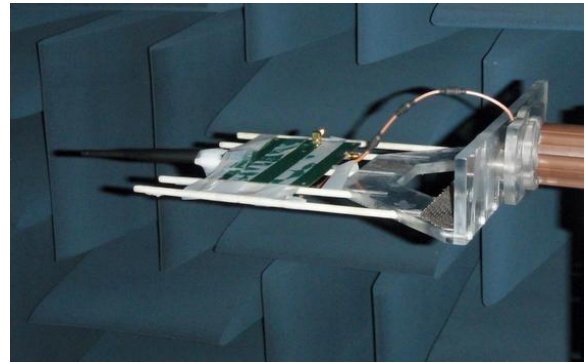

Small ground edge



Big ground edge

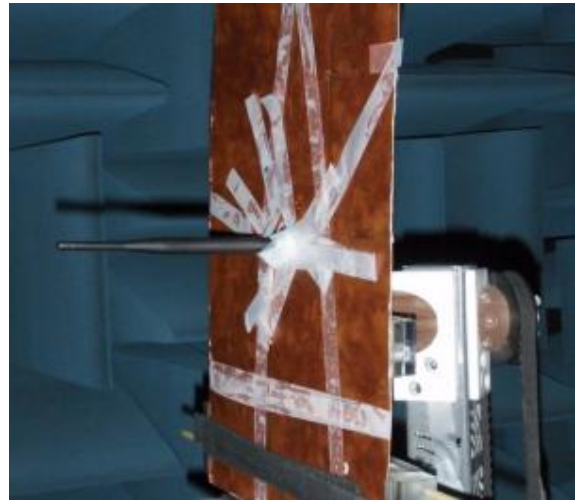

Big ground center

VI. S11 Performance of TI.15 with Different Ground

Bend Position Return Loss

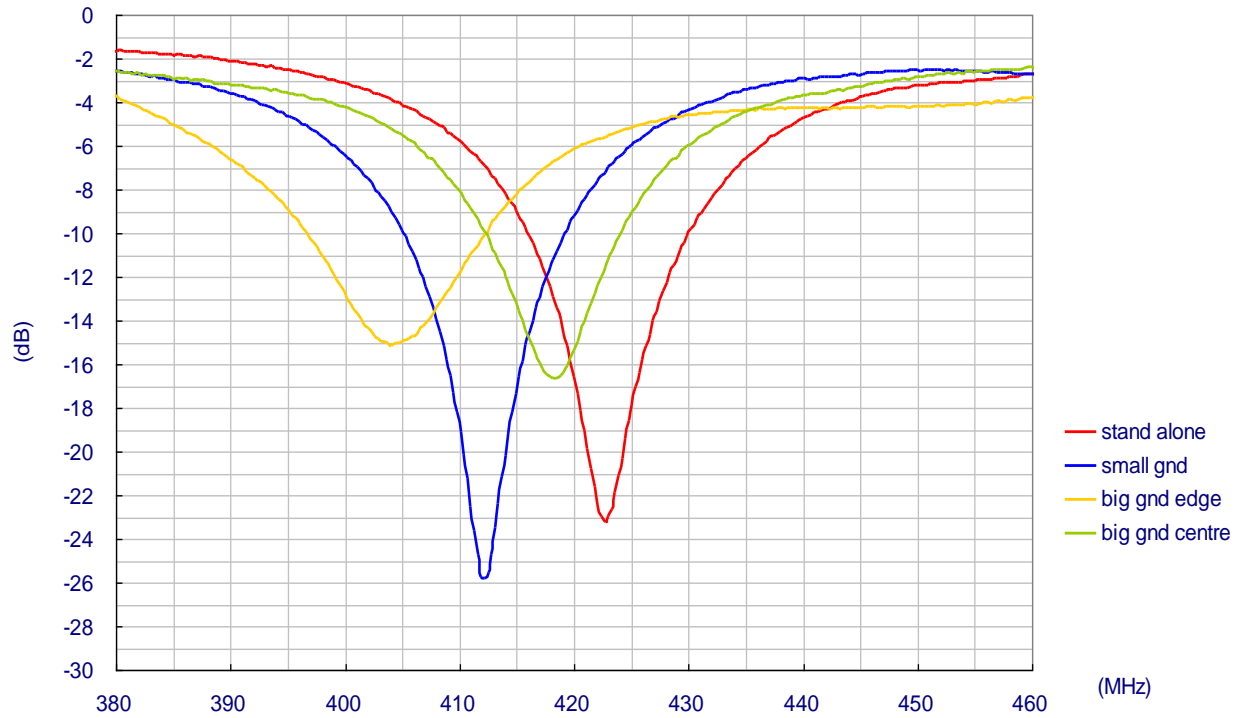

Straight Position Return Loss

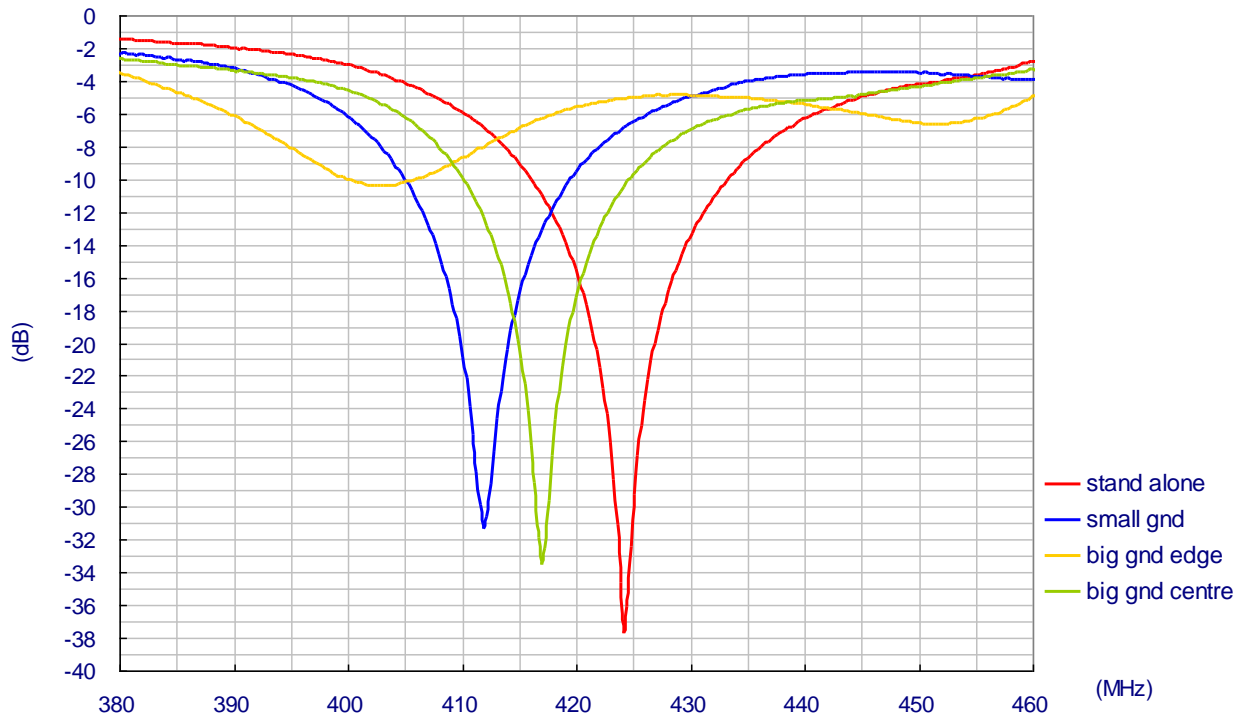

Bend Position VSWR

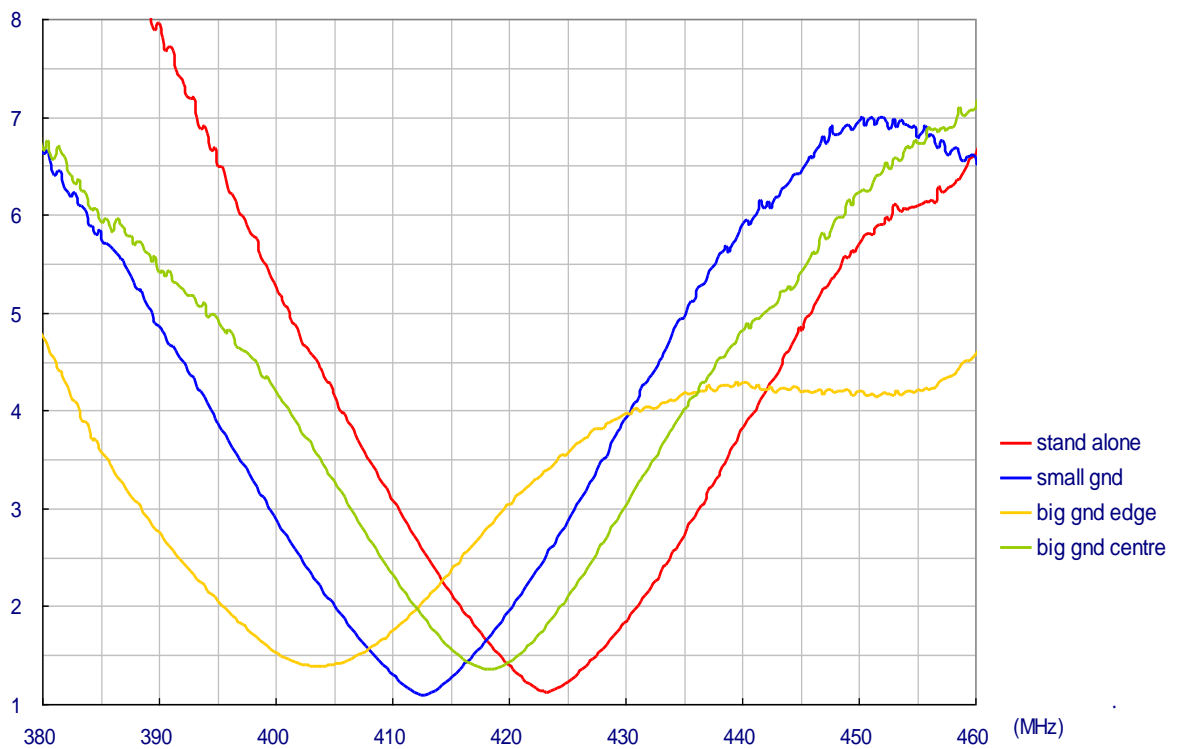

Straight Position VSWR

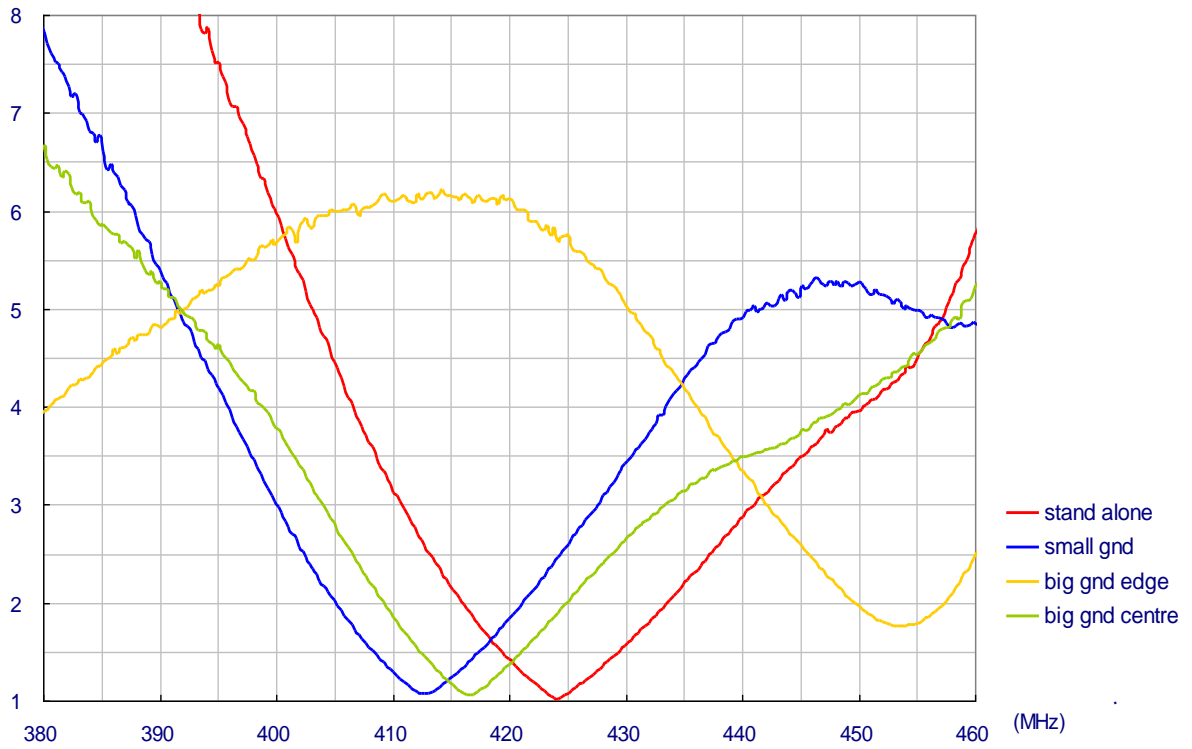

VII. Antenna Radiation Property

VII.1. Bend Position Radiation Efficiency

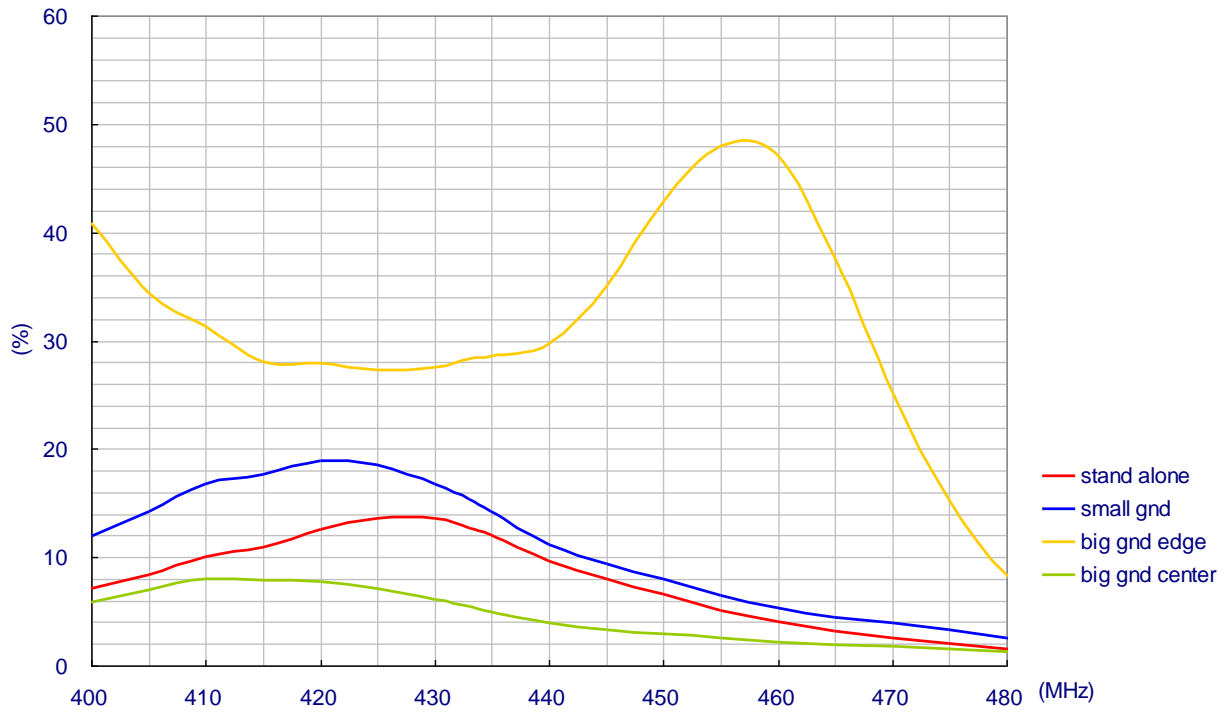

VII.2. Straight Position Radiation Efficiency

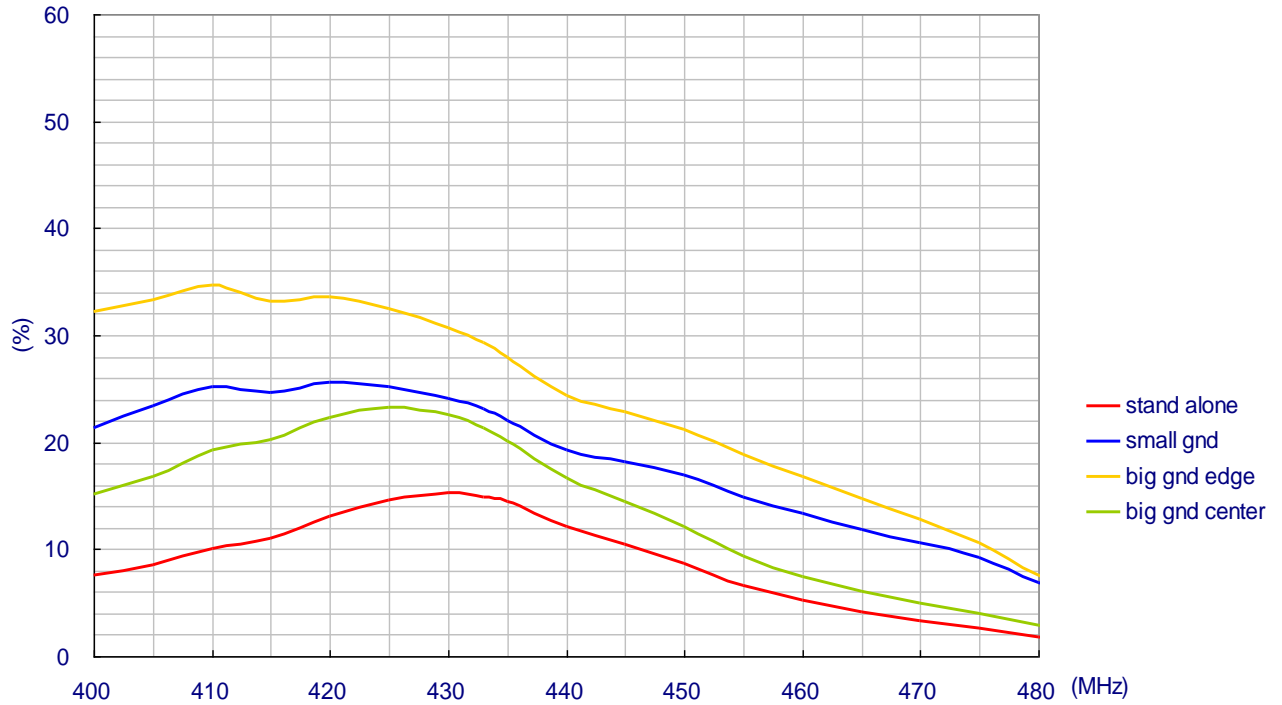

VII.3. Bend Position Peak Gain

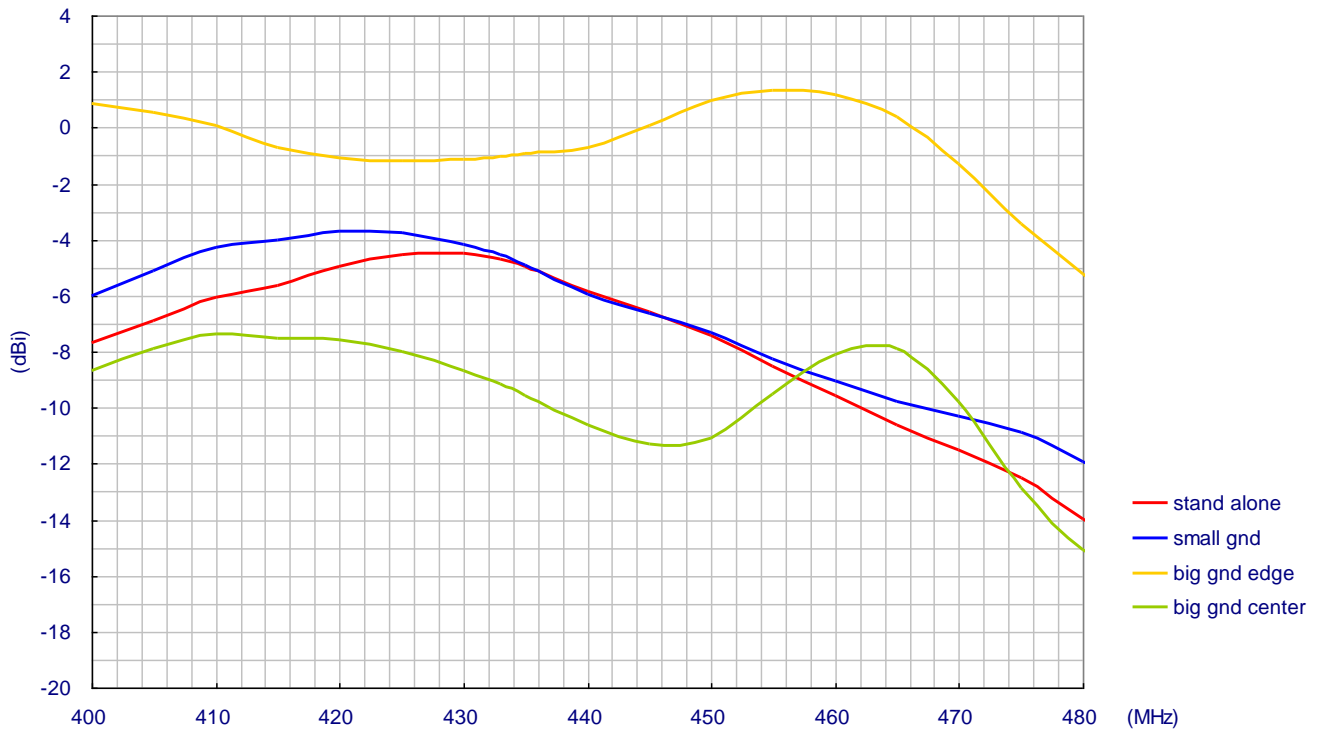

VII.4. Straight Position Peak Gain

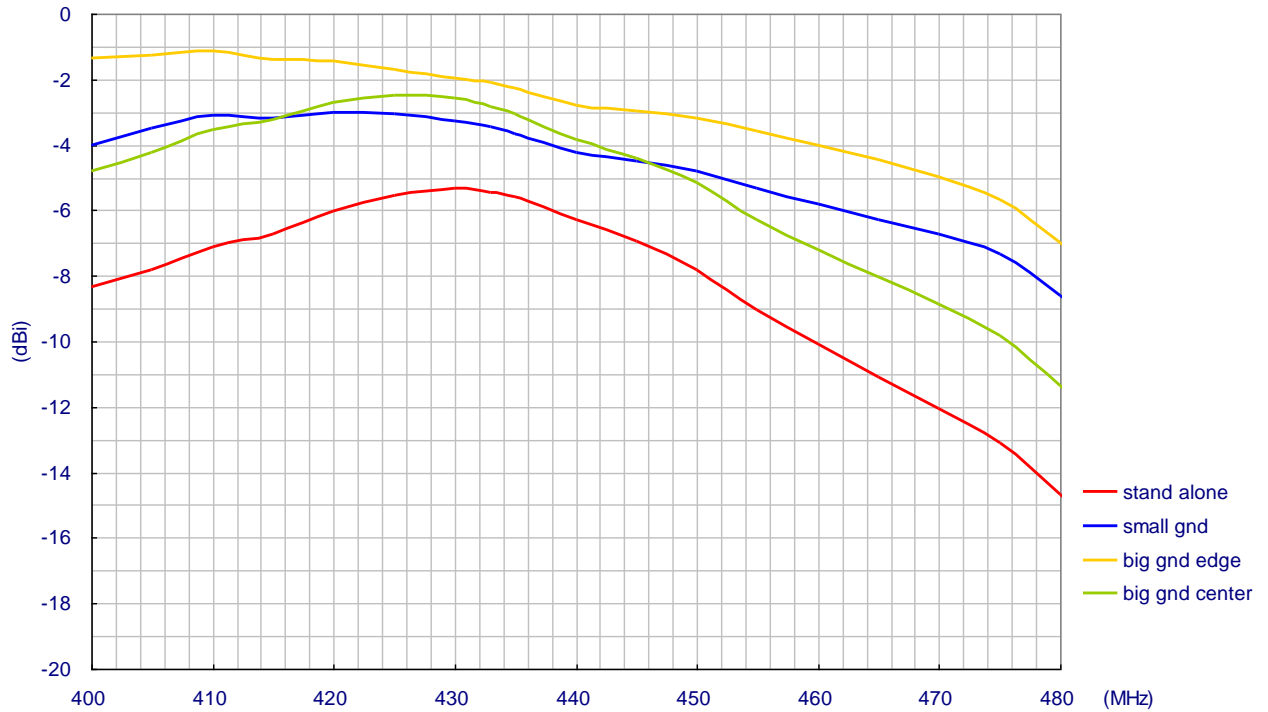

VII.5. Bend Position Average Gain

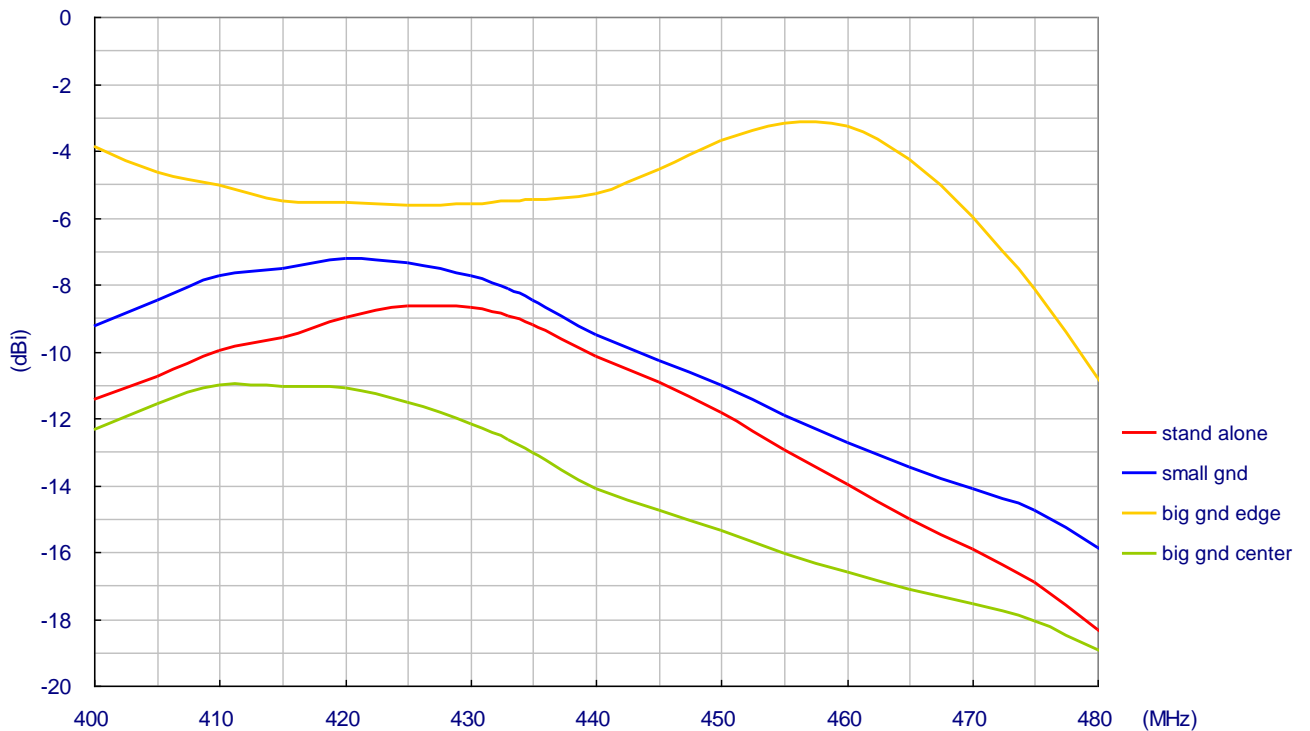

VII.6. Straight Position Average Gain

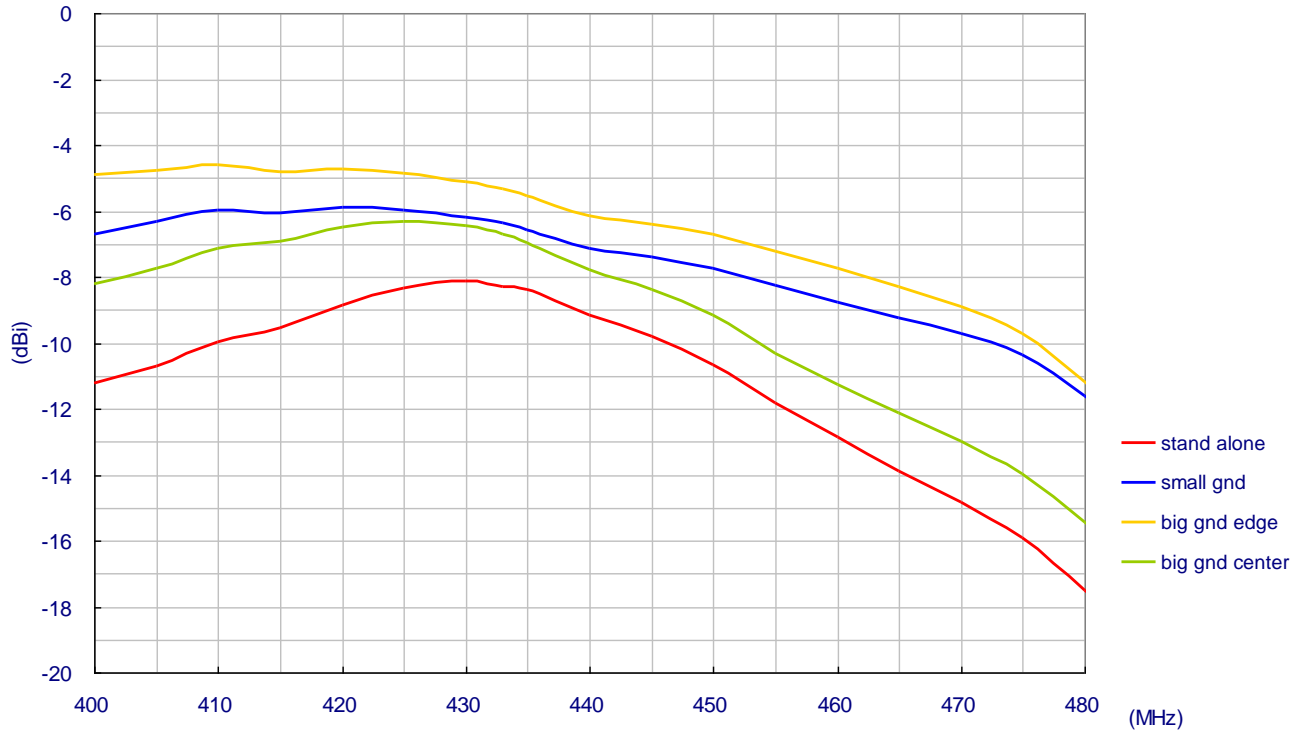

VII.7. 433MHz Bend Position Radiation Pattern

H-plane Radiation

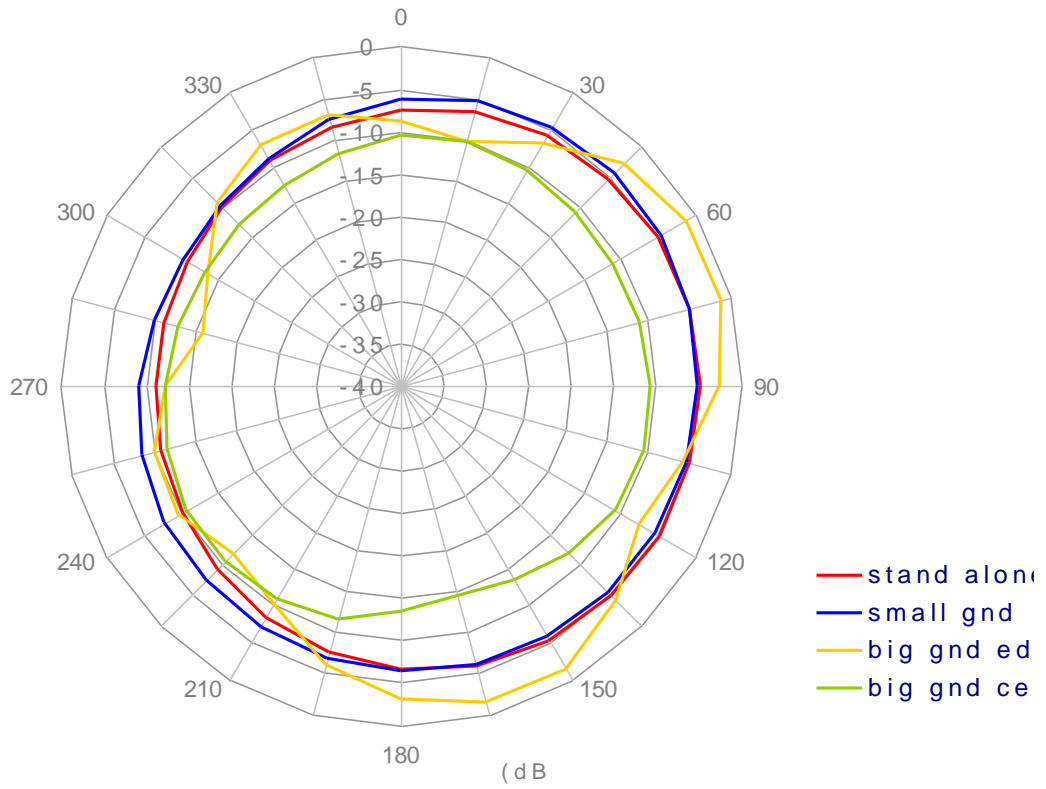

E-plane Radiation

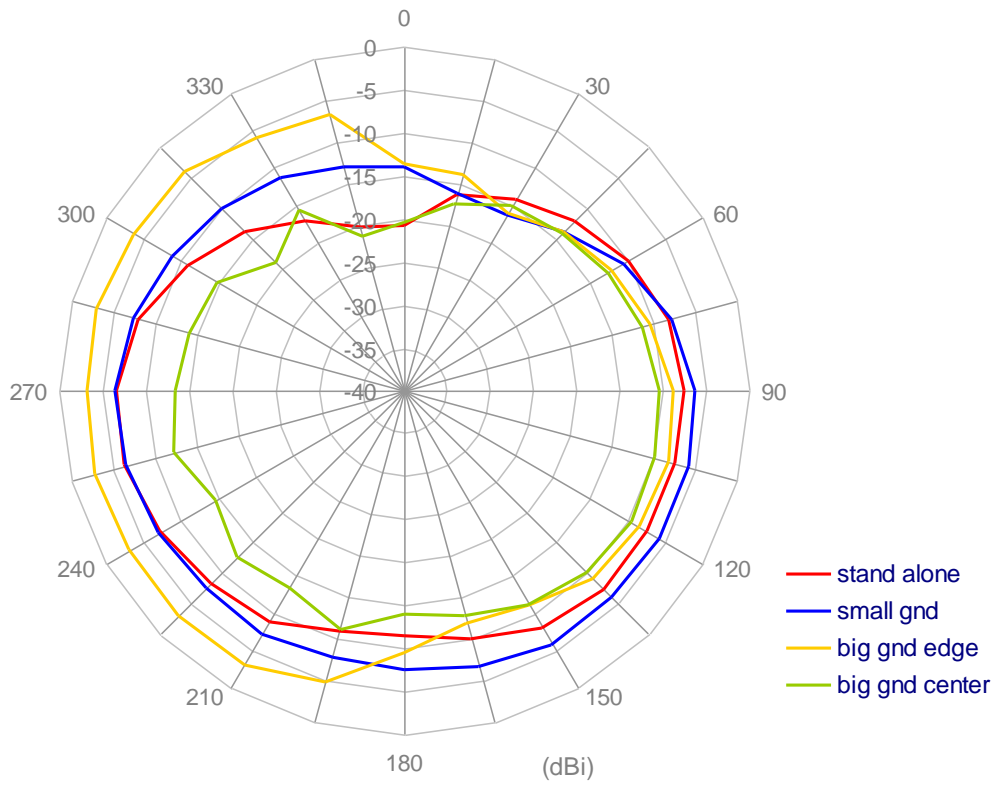

VII.8. 433MHz Straight Position Radiation Pattern

H-plane Radiation

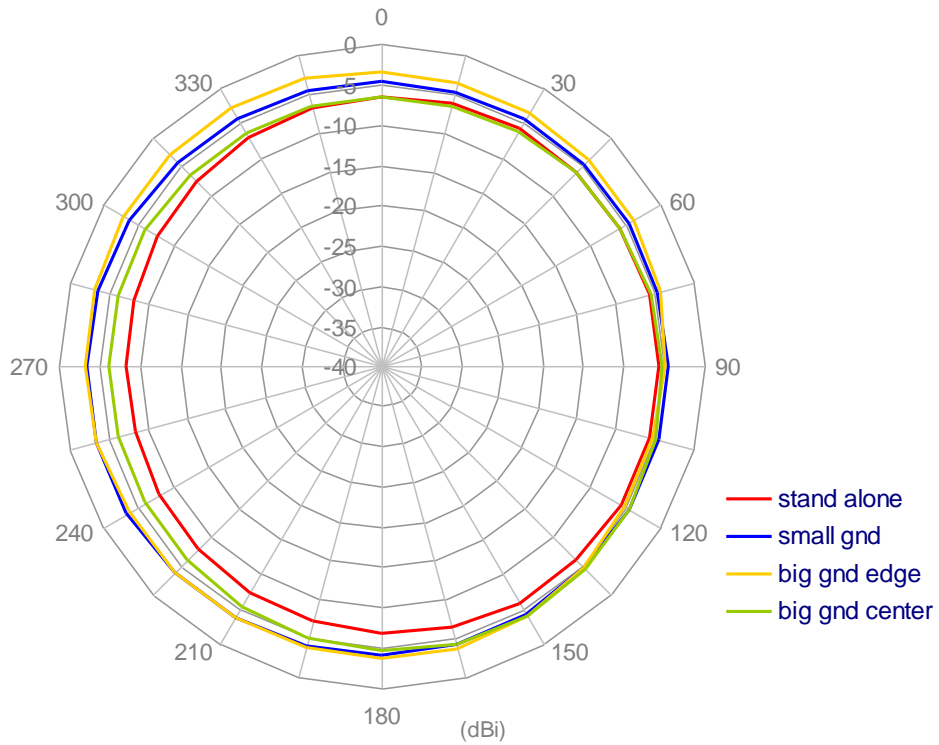

E-plane Radiation

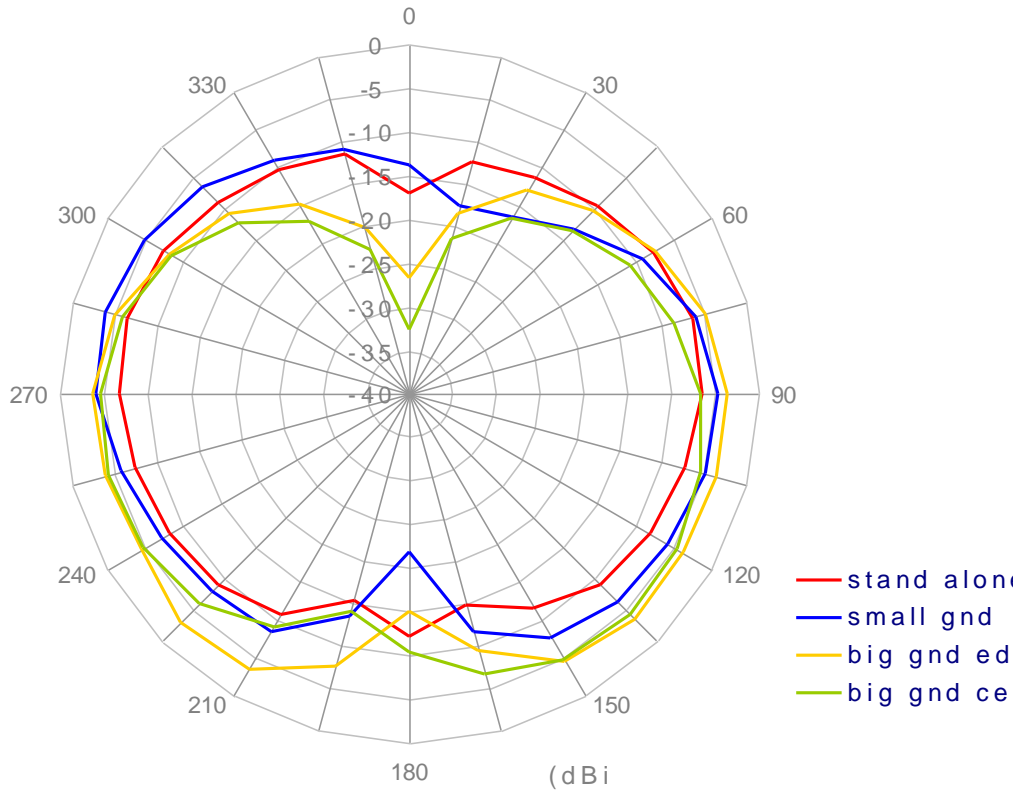

VIII. Mechanical Drawing

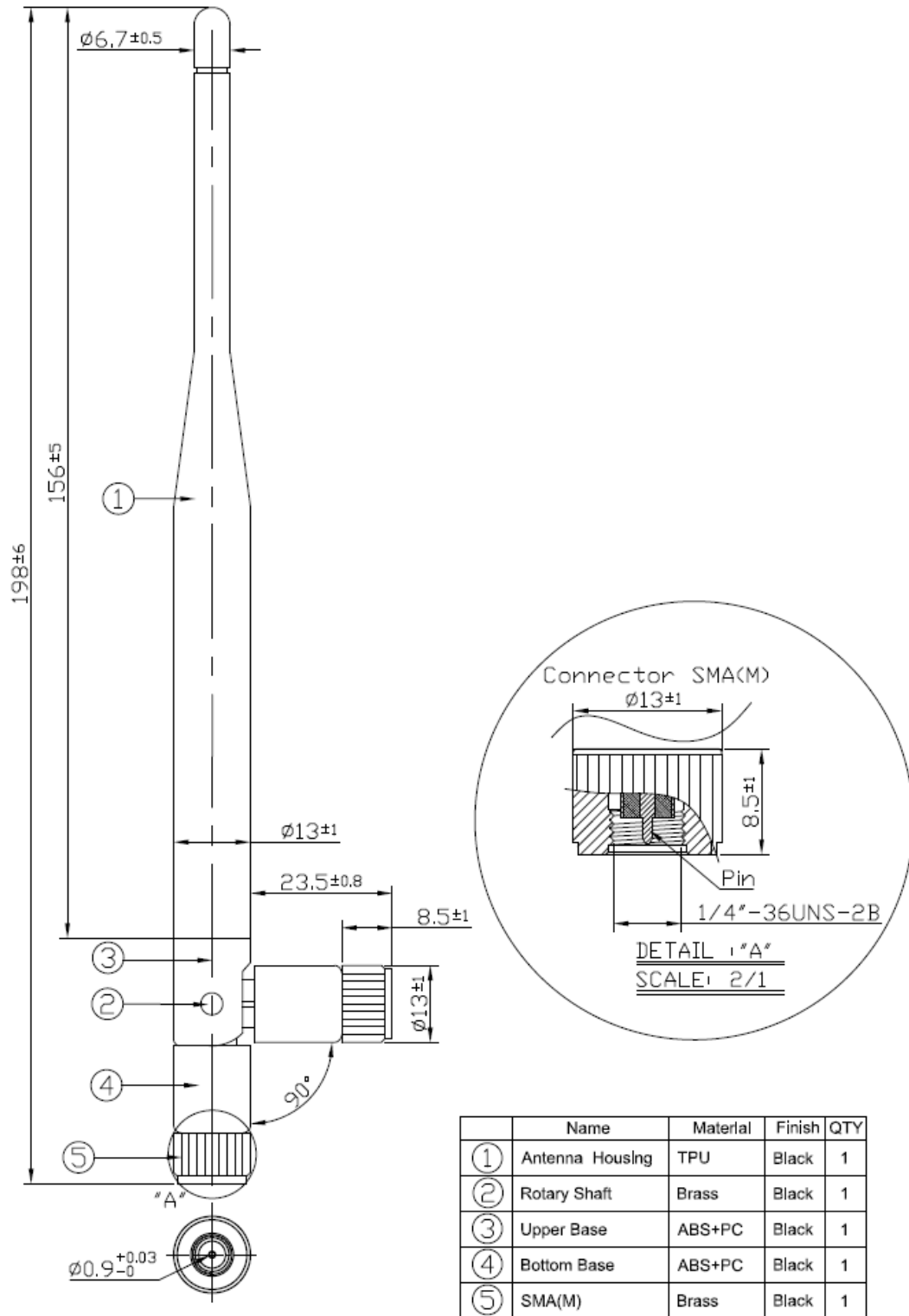

Unit : mm

Looking for pricing, stock, or lifecycle information?

Click below to explore more details on WIN SOURCE:

 [View TI.15.3113](#) on WIN SOURCE

 [Taoglas Limited](#) Information

Optimize Your Supply Chain with WIN SOURCE Solutions

-  Global Sourcing Solution
-  Obsolete Management
-  Cost Control Management
-  Shortage Management
-  Alternative Solution
-  Excess Inventory Management