



**THE DATASHEET OF
8551SZQE2**



8500 Series

Subminiature Pushbutton Switches



Agency Approvals

Agency	Agency File Number
US	E42363

Specifications

Contact Rating	Q contact material (853X models): 1 amp @ 120 V AC or 28 V DC; (855X models): 3 amps @ 120 V AC or 28 V DC.
Electrical Life	853X models: 250,000 actuations at full load. 855X models: 10,000 actuations at full load.
Contact Resistance	Below 30 mΩ typ. initial @ 2-4 V DC, 100 mA, for both silver and gold plated contacts.
Insulation Resistance	10 ⁹ Ω min.
Dielectric Strength	1000 Vrms min. @ sea level.
Operating Temperature	-30°C to 65°C
Torque Specs	T, T1 15/32" bushings - 50 in. lbs max. All other ¼ -40 bushing types 12 in. lbs max.

Notes:

Any models supplied with Q, B or G contact material are RoHS compliant. Specifications and materials listed above are for switches with standard options. For information on specific and custom switches, consult Customer Service Center.

Description

For those designers that need a reliable pushbutton switch for their networking, computing, telecommunications or detection products, the 8500 series of subminiature pushbutton switches are the perfect fit. Designed for ratings up to 3A, the 8500 switches have a reliable contact design and are available in pre-travel or over-travel models.

Features & Benefits

- Pre-travel or over-travel models available
- Ratings up to 3 AMPS
- Reliable contact design
- RoHS compliant

Applications

- Detection
- Computers and peripherals
- Telecommunications and networking equipment

Materials

Case	Glass filled phenolic or diallyl phthalate (DAP) (UL 94 V-0).
Plunger	Phenolic or glass filled polyester, black standard (UL 94 V-0).
Cap & Frame	Nylon, black, standard.
Bushing	Brass or nickel plated
Contacts	Q contact material: Coin silver, silver plated.
Terminals	Q contact material: Copper alloy, silver plated.
Terminal Seal	Epoxy.
Hardware	Nut: Brass, nickel plated; Lockwasher: Steel, bright nickel plated.

8500 Series

Subminiature Pushbutton Switches



Ordering Number

To order, simply select desired option from each category and place in the appropriate box. For additional options not shown in catalog, consult Customer Service Center. All models have epoxy terminal seal and are compatible with all "bottom-wash" PCB cleaning methods.

85xx - x - x - x - x - x - x

- Switch Function**
 - 8531: SPST Off-Mom. 1 Amp
 - 8532: SPST Off-Mom. 1 Amp
 - 8533: SPST On-Mom. 1 Amp
 - 8534: SPST On-Mom. 1 Amp
 - 8551: SPST Off-Mom. 3 Amp
 - 8552: SPST Off-Mom. 3 Amp
- Actuator or Plunger**
 - M: 0.150" high
 - J81: Snap-in w/ frame
 - J82: Snap-in w/ frame for LED
 - S: 0.210" high
 - T: 15/32 bushing
 - T1: 15/32 bushing with frame (8532 and 8534 only)
- Seal**
 - E: Epoxy
 - D: No epoxy seal
- Terminations**
 - Z: Solder lug
 - AV: Right angle, PC thru-hole
 - C: PC Thru-hole
- Frame Color**
 - 2: Black
 - NONE: Models without frame
- Cap or Plunger Color**
 - 2: Black
 - 1: White
 - 3: Red
 - 9: Gray
- Contact Material**
 - Q: Silver
 - B: Gold
 - G: Gold over silver

Notes:
 1. Available with M or S plunger models, and B contact material only.

Switch Function SPST

No. Poles	Model NO.	Rating	Switch Function		Total Travel inches (mm)	Actuation Force	Schematic
			POS. 1	POS. 2			
SP	8531	1 AMP	OFF	MOM.	0.095 (2.41) TYP. with overtravel 0.042 (1.07) TYP.	7.7 oz (220g) TYP.	N.O. with overtravel
	8551	3 AMPS					

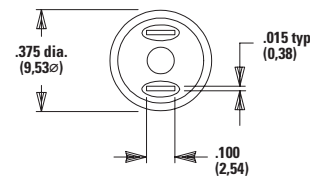
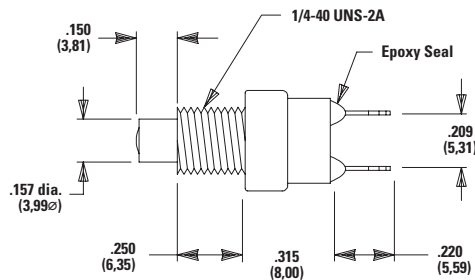

Terminal Nos. For Reference Only

Part Number Shown: 8531MZQE2

8500 Series

Subminiature Pushbutton Switches



SPST

No. Poles	Model NO.	Rating	Switch Function		Total Travel inches (mm)	Actuation Force	Schematic
			POS. 1	POS. 2			
SP	8532	1 AMP	OFF	MOM.	0.050 (1.27) TYP.	6 oz. (170g) TYP.	
	8552	3 AMPS					

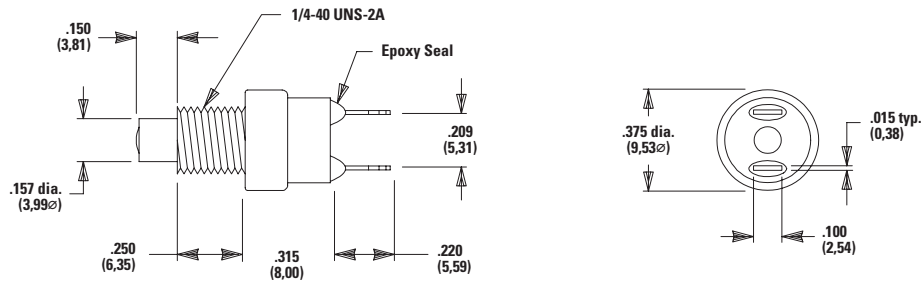

Part Number Shown: 8532MZQE2

SPST

No. Poles	Model No.	Rating	Switch Function		Total Travel inches (mm)	Actuation Force	Schematic
			POS. 1	POS. 2			
SP	8533	1 AMP	ON	MOM.	0.080 (2.03) TYP. With pretravel 0.057 (1.45) TYP.	11.5 oz (456g) TYP.	
	8534	1 AMP			0.032 (0.81) TYP. With overtravel 0.028 (0.71) TYP.		

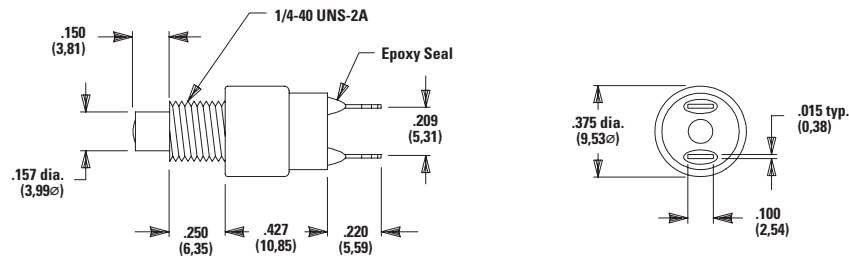

Part Number Shown: 8532MZQE2

Notes: MOM. = Momentary. All models with all options when ordered with G or Q contact material.

8500 Series

Subminiature Pushbutton Switches



Plunger

M 0.150" High Plunger

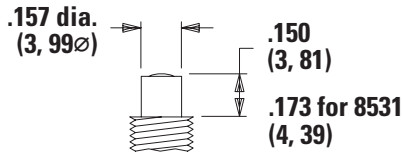

S 0.210" High Plunger

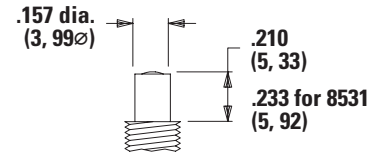

Option Code	Plunger Color
2	Black
3	Red

Notes: One mounting nut and lockwasher supplied with all actuators (except T actuator: two nuts supplied).

Panel Mounting



Actuator

T 15/32 Bushing

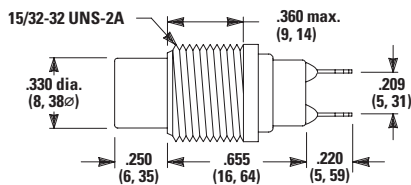

Notes: No frame color choice required.

Panel Mounting

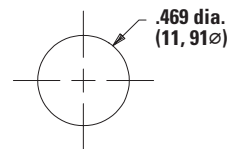

T1 15/32 Bushing with Frame

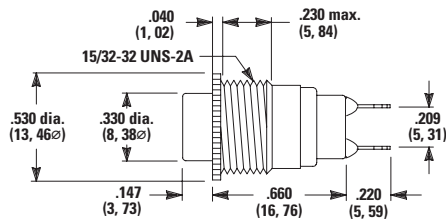

Notes: No frame color choice required. Available with 8532 and 8534 models only.

Option Code	Plunger Color
2	Black
1	White
3	Red
9	Grey

Notes: Cap Finish: gloss. Other colors available, consult Customer Service Center. One mounting nut and lockwasher supplied with all actuators (except T actuator: two nuts supplied). Caps available for plunger options, see page 7.

8500 Series

Subminiature Pushbutton Switches



Actuator - Snap-in Front Mount

J81 Snap-in with Black Frame

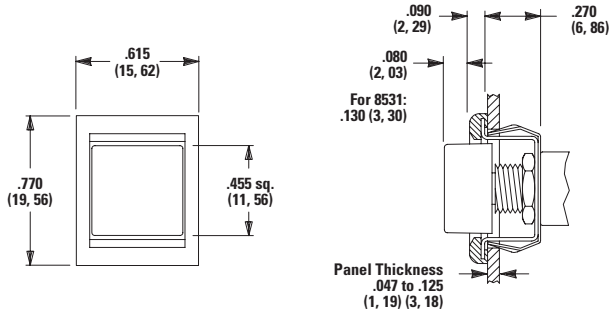

Option Code	Cap and Frame Color
2	Black

Notes:

Cap and Frame Finish: matte. Other colors available, consult Customer Service Center. One mounting nut and lockwasher supplied with all actuators. Caps & frames available separately, see page 7.

J82 Snap-in with Black Frame for LED

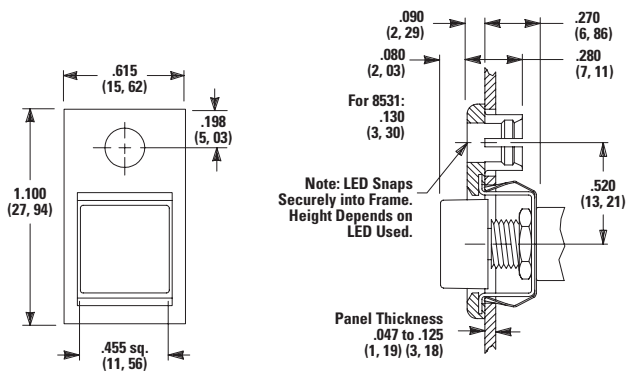

Notes:
LED not included For LED information, see page 9.

Panel Mounting

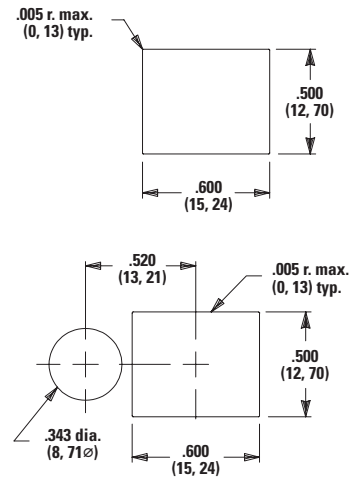

Terminations

Z Solder Lug

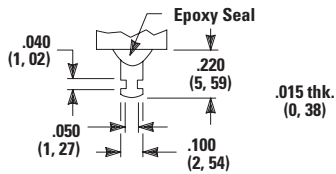

C PCThru-hole

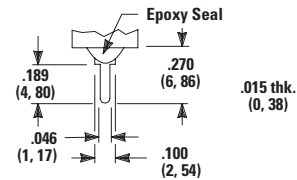

PC Mounting

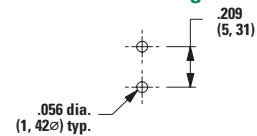

8500 Series

Subminiature Pushbutton Switches



AV Right Angle, PC Thru-hole

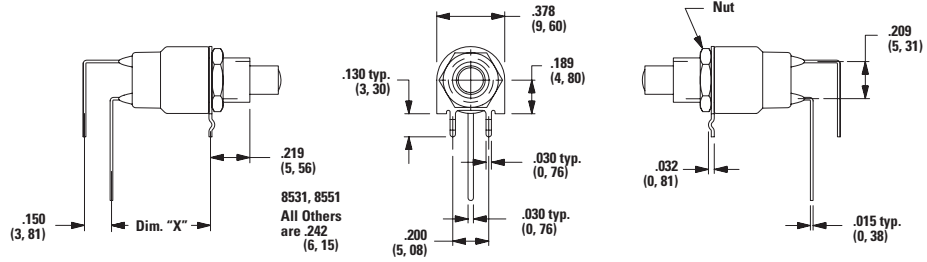

Notes:
Available with M or S plunger models, and B contact material only.

PC Mounting

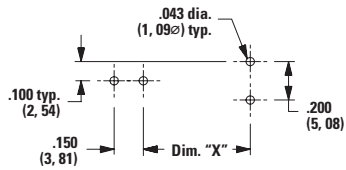

Model No.	DIM "X"
8531, 8533	0.550
8532, 8534	0.438

8500 Series

Subminiature Pushbutton Switches



Contact Material

Option Code	RoHS Compliant ¹	RoHS Compatible ¹	Terminal Plating	Contact Material		Ratings
B	Yes		Gold ¹	Gold	Low Level/Dry Circuit	0.4 VA max. @ 20 V AC or DC max.
Q		Yes	Silver ⁴	Silver ⁵	Power	853X models: 1 amp @ 120 V AC or 28 V DC. 853X models: 3 amps @ 120 V AC or 28 V DC.
G	Yes		Gold over Silver ²	Gold ³	Low Level/Dry Circuit or Power	0.4 VA max. @ 20 V AC or DC max. 853X models: 1 amp @ 120 V AC or 28 V DC. 853X models: 3 amps @ 120 V AC or 28 V DC.

Notes:

See Technical Data section of this catalog for RoHS compliant and compatible definitions and specifications.

1. Contacts & Terminals: Copper alloy, with gold plate over nickel plate.

2. Contacts: Coin silver, with gold plate over nickel plate.

3. Terminals: Copper alloy, with gold plate over nickel plate.

4. Contacts: Coin silver, silver plated.

5. Terminals: Copper alloy, silver plated.

Any models supplied with Q, B or G contact material are RoHS compliant. All models  us with all options when ordered with G, or Q contact material. Q contact material standard with C, Z terminations. 8551 & 8552 available with Q contact material only.

Seal

E Epoxy Seal

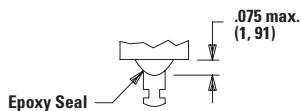

Replacement Hardware

Cap, Snap Fitting Plunger

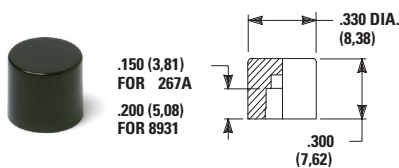

Part No.
267A01000 White
267A02000 Black
267A03000 Red
267A09000 Gray
85X2T, 8534T models only
Material: Nylon
Finish: Gloss

Part No.
893101000 White
893102000 Black
893103000 Red
893109000 Gray
85X1T, 8532T1, 8533T, 8534T1 models only
Material: Nylon
Finish: Gloss

Cap, J80, J81 & J82 options only

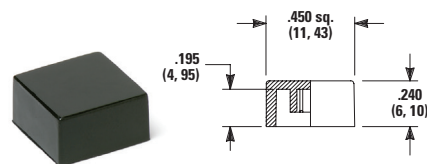

Part No.
448901000 White
448902000 Black
448903000 Red
448909000 Gray
Material: Nylon
Finish: Gloss or matte

Notes: Other colors available, consult Customer Service Center.

8500 Series

Subminiature Pushbutton Switches



Frame



Part No.
6156022263 Black
Material: Nylon
Finish: Matte

Frame



Part No.
6156022263 Black
Material: Nylon
Finish: Matte

Notes: Additional nuts, locking rings and lockwashers available separately, see section "Technical Data and Additional Hardware". Other cap & frame colors available, consult Customer Service Center.

Frames snap into panel opening and are independent from switch mounting. Accurate positioning of the PC mounted switch relative to the panel opening is necessary to provide proper clearance between actuator and frame. Available in two basic styles and four panel thicknesses 0.047 - 0.125 in. Material: Nylon. Finish: Matte.

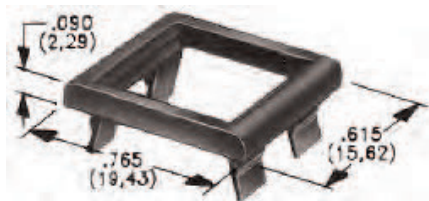

0.090" (2.29) Panel THK.
Part No. 432702263

0.125" (3.18) Panel THK.
Part No. 432802263 Black

Typical Applications

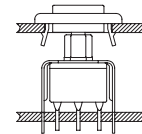

Panel Inserts

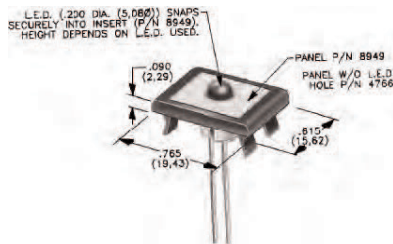

For Part Numbers
4325xxxxx, 4326xxxxx

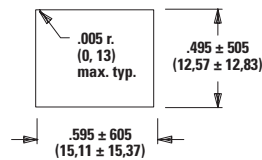

For Part Numbers
4327xxxxx, 4328xxxxx

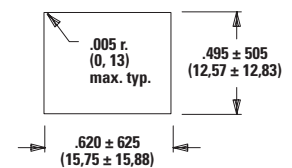

Above frames (part nos. 432XXXXXX) are also available with insert which accepts LED for indicator light assembly. Order insert separately from frame. Blank insert panel (without hole for LED) also available. LED not included.

Panel insert with hole for LED
Part No. 894902000

Blank panel insert
with **Part No.** 476602000 Black

Special colors, custom markings available, consult Customer Service Center.

8500 Series

Subminiature Pushbutton Switches



LED Information

LEDs are not supplied with J82 option. LED snaps into switch frame surrounding actuator and is wired externally.

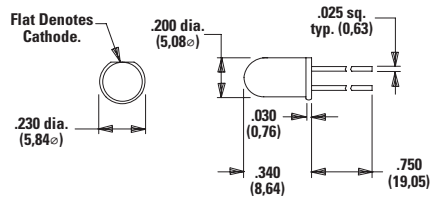

Suggested LED for J82 options.
Dimensions for reference only.

Process Information: Soldering to LED leads must be completed within 5 seconds at 500°F (260°C) maximum.

Looking for pricing, stock, or lifecycle information?

Click below to explore more details on WIN SOURCE:

 [View 8551SZQE2 on WIN SOURCE](#)

 [C&K Components](#) Information

Optimize Your Supply Chain with WIN SOURCE Solutions

-  Global Sourcing Solution
-  Obsolete Management
-  Cost Control Management
-  Shortage Management
-  Alternative Solution
-  Excess Inventory Management