



**THE DATASHEET OF  
ASKHC2A04AC**



# A Series

## General Purpose Snap-acting Switches



### Agency Approvals

Agency	Agency File Number
	E42363

### Specifications

<b>Contact Rating</b>	From low level <sup>1</sup> to 25 amps @ 277 V AC
<b>Electrical Life</b>	75,000 cycles at 25 amps @ 250 V AC, 200,000 cycles at 15 amps @ 250 V AC.
<b>Insulation Resistance</b>	1,000 M ohm min.
<b>Dielectric Strength</b>	1,000 Vrms min. @ sea level
<b>Operating Temperature</b>	-55°C to +150°C
<b>Operating Force</b>	20 oz. (567 grams) max. SP models. 40 oz. (1134 grams) max. DP models at actuator button.
<b>Mounting</b>	Torque 3 in/lbs max.
<b>Mounting Nut</b>	20 in/lbs max. torque

#### Notes:

1. Low Level = conditions where no arcing occurs during switching. i.e. 0.4 VA max. @ 20 V AC or DC max.

Specifications and materials listed above are for switches with standard options. C&K does provide specific and custom switches at 30 amps @ 277 VAC. Please consult Customer Service Center.

### Description

The A series are general purpose snap-acting switches, aimed for use in applications such as garage door openers, vending machines or enclosure equipment. The A series is known for being low-cost yet high-performance, with a long electrical life. The A series switches are available in single and double pole varieties and have a sealed actuator option available as well.

### Features & Benefits

- Low cost—high performance
- Long electrical life
- Single and double pole
- Sealed actuator option available

### Applications

- Enclosure equipment
- Garage door openers
- Vending machines

### Materials

<b>Switch Housing</b>	Heat resistant phenolic (UL 94V-0)
<b>Actuator Button</b>	
<b>Spring</b>	Copper alloy.
<b>Pivot</b>	Brass alloy for models up to 15 amps. Copper for 25 amp models.
<b>Movable Contacts</b>	Gold alloy for ratings 1 amp or less. Fine silver for ratings up to 15 amps. Silver alloy for ratings of 25 amps.
<b>Stationary Contacts</b>	Gold alloy on brass base alloy for ratings 1 amp or less. Fine silver welded on brass base alloy for ratings greater than 1 amp up to 15 amps. Fine silver welded on copper alloy for ratings 25 amps.
<b>Terminals</b>	Brass alloy for 1 AMP up to 15 amps. Copper alloy for 25 amps.

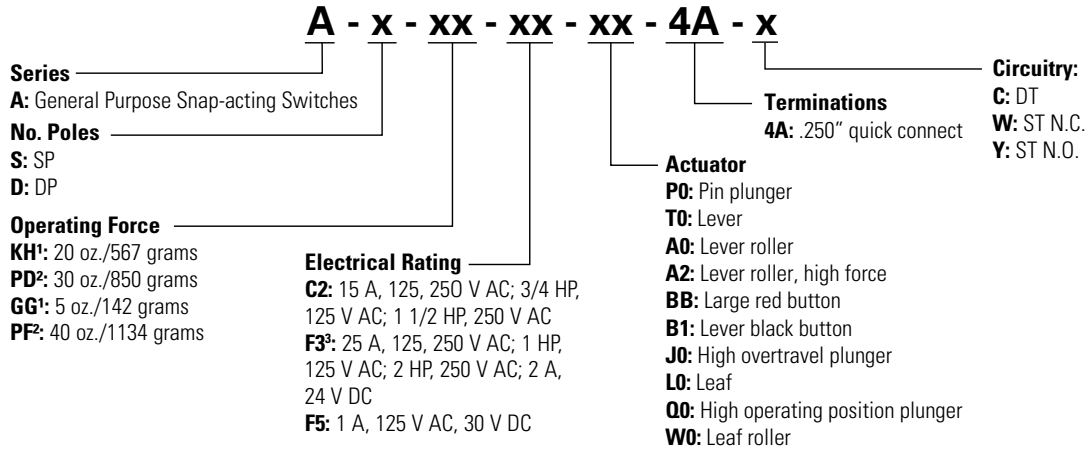
# A Series

## General Purpose Snap-acting Switches



### Ordering Number

To order, simply select desired option from each category and place in the appropriate box. For additional options not shown in catalog, consult Customer Service Center.

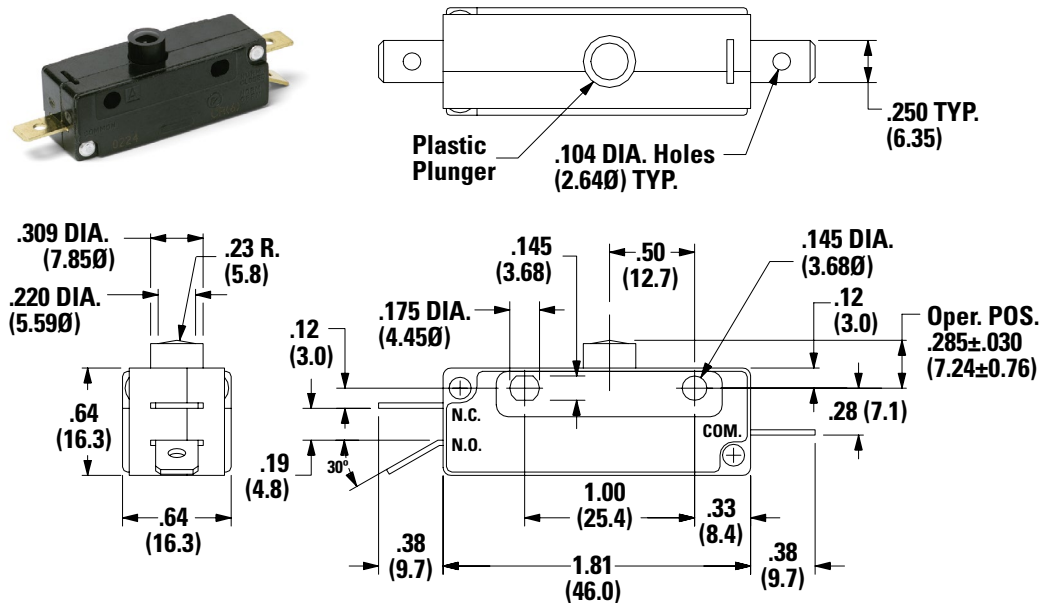


- Notes:**
1. Single Pole
  2. Double Pole
  3. UL verified ratings, 25A, 125, 250VAC, 2A, 24VDC.

### A Series - General Purpose Snap-Acting Switches

#### No. Poles

#### S Single Pole Switch Dimensions inches (mm)



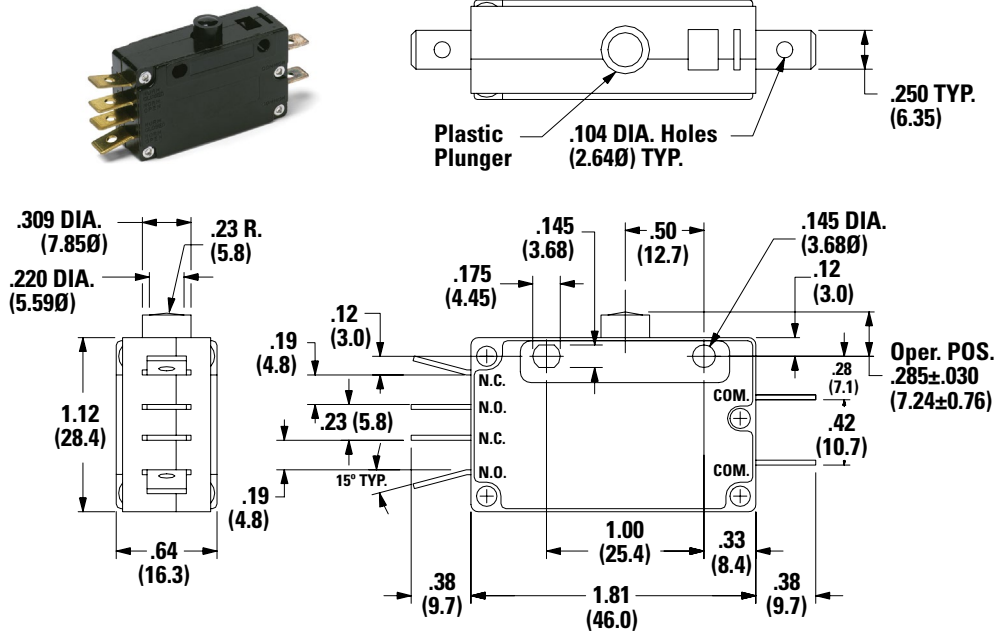
- Notes:**
- Mounting holes will accept pins or screws of 0.139 dia. (3.53) max. on 1.000 (25.40) centers.

# A Series

## General Purpose Snap-acting Switches



### D Double Pole Switch Dimensions inches (mm)



**Notes:**  
 Mounting holes will accept pins or screws of 0.139 dia. (3.53) max., on 1.000 (25.40) centers.  
 To select switching function, see CIRCUITRY section, page 6.

### Operating Force

Option Code	No. Poles	Basic Switch Operating Force (oz./grams)
KH	SP	20/567
PD	DP	30/850
GG	SP	5/142
PF	DP	40/1134

**Notes:**  
 Operating force varies with actuator, see ACTUATOR option section.

### Electrical Rating

Option Code	Movable Contact	Stationary Contact	Electrical Rating
C2	Fine silver	Fine silver welded on brass base alloy	15 amps @ 125 & 250 V AC; 3/4 HP @ 125 V AC; 1-1/2 HP @ 250 V AC
F3	Silver Alloy	Silver welded on copper base alloy	25 amps @ 125 & 250 V AC; 1 HP @ 125 V AC; 2 HP @ 250 V AC; 2 amps @ 24 V DC
F5	Gold alloy	Gold alloy on brass base alloy	From low level <sup>1</sup> to 1 amp @ 125 V AC, 30 V DC

**Notes:** See Technical Data section of this catalog for RoHS compliant and compatible definition and specifications. All models with all options. Consult Customer Service center for availability and delivery of nonstandard ratings.

<sup>1</sup> Low Level=conditions where no arcing occurs during switching. i.e. 0.4 VA max. @ 20 V AC or DC max.

### Available Combinations

Electrical Rating	Operating Force (oz./grams)			
	GG 5/142	KH 20/567	PD 30/850	PF 40/1134
C2	•	•	•	•
F3	X	•	•	•
F5	•	•	•	•

**Notes:** • Available. X Not available.

# A Series

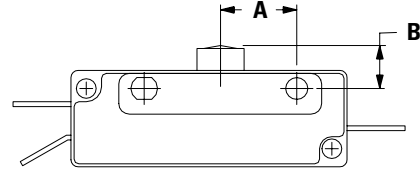
## General Purpose Snap-acting Switches



### Actuator

Option Code	Fig.	Dim. A	Dim. B	Dim. C	Dim. D	Dim. E	Dim. F
P0	1	0.50 (12.7)	0.285 ± 0.030 (7.24 ± 0.76)	-	-	-	-
A0	3	1.38 (35.1)	0.718 ± 0.062 (18.24 ± 1.57)	0.375 dia. (9.53Ø)	0.50 (12.7)	0.50 (12.7)	-
A2	4	1.25 (31.8)	0.718 ± 0.062 (18.24 ± 1.57)	0.375 dia. (9.53Ø)	0.50 (12.7)	-	-
B1	6	1.50 (38.1)	0.40 ± 0.1 (10.2 ± 2.54)	0.98 dia. (24.9Ø)	-	-	-
BB	6	1.50 (38.1)	0.40 ± 0.1 (10.2 ± 2.54)	0.98 dia. (24.9Ø)	-	-	-
J0	5	0.50 (12.7)	0.810 ± 0.030 (20.6 ± 0.8)	0.38 (9.7)	0.25 dia. (6.4Ø)	-	-
L0	2	1.62 (41.1)	0.312 ± 0.062 (17.92 ± 1.57)	0.50 (12.7)	-	-	-
Q0	5	0.50 (12.7)	0.670 ± 0.030 (17.02 ± 0.76)	0.38 (9.6)	0.25 dia. (6.4Ø)	-	-
T0	7	1.50 (38.1)	0.318 ± 0.062 (8.08 ± 1.57)	0.50 (12.7)	0.50 (12.7)	-	-
W0	8	1.50 (38.1)	0.801 ± 0.062 (20.34 ± 1.57)	.375 dia. (9.53Ø)	0.50 (12.7)	-	-

Figure 1 High Overtravel Plunger



Note: The "H0" high overtravel plunger option provides 0.100 (2.54) min. overtravel and longer mechanical life (1,000,000 operations typical).

Figure 2 Leaf

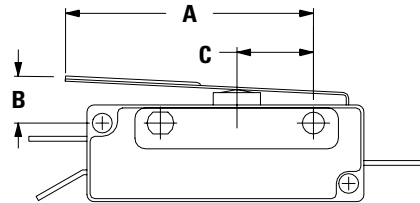


Figure 3 Lever Roller

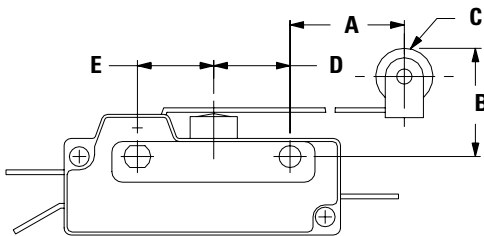
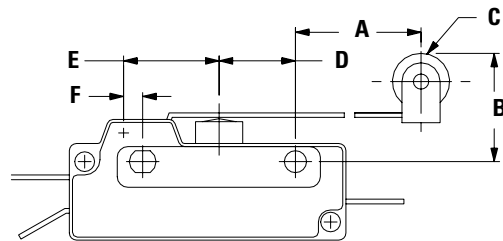


Figure 4 Lever Roller (High Force)

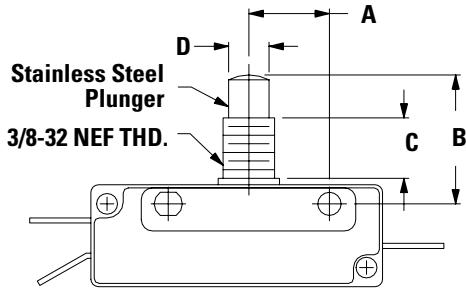


# A Series

## General Purpose Snap-acting Switches

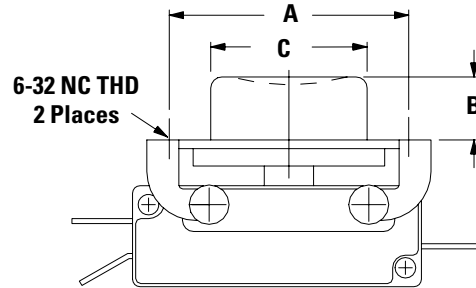


Figure 5 High Overtravel Plunger

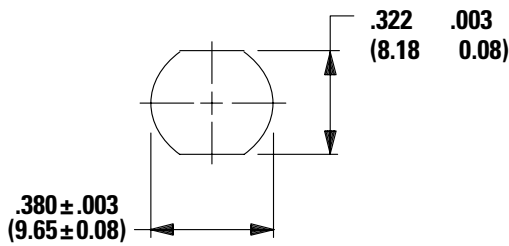


Notes:  
Torque 20 in/lbs. max. (Nut)

Figure 6 - B1 Black Button - BB Red Button



Panel Mounting



Panel Mounting

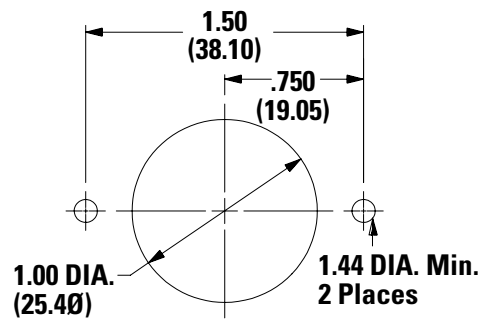


Figure 7 Lever

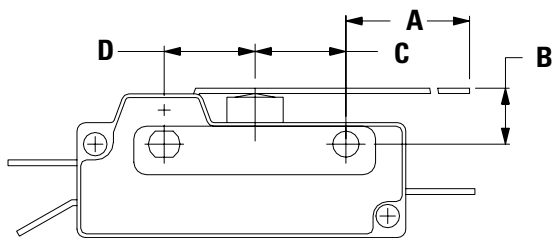
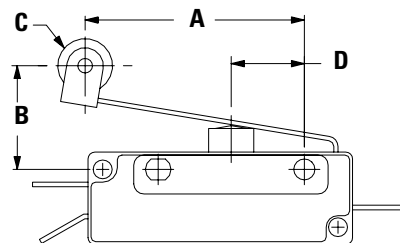


Figure 8 Leaf Roller



# A Series

## General Purpose Snap-acting Switches



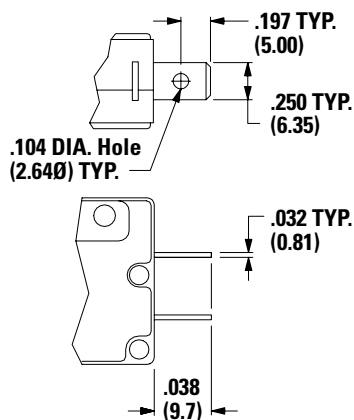
### Actuator Switch Characteristics

Option Code	Max. Operating Force (oz./grams)				Min. Release Force (oz./grams)				Max. Pre-travel				Max. Pre-travel				Operating Position			
	GG S.P.	KH S.P.	PD D.P.	PF D.P.	GG S.P.	KH S.P.	PD D.P.	PF D.P.	GG S.P.	KH S.P.	PD D.P.	PF D.P.	GG S.P.	KH S.P.	PD D.P.	PF D.P.	GG S.P.	KH S.P.	PD D.P.	PF D.P.
A0	1.5 42.5	4 113	6 170	10 283	0.3 8.5	0.5 14	1 28	1 28	0.312 (7.92)				0.312 (7.92)		0.187 (4.75)		0.718 (18.24)			
A2	1.5 42.5	4 113	6 170	10 283	0.4 11	0.5 14	1 28	1 28	0.25 (6.4)				0.14 (5.6)				0.718 (18.24)			
B1	8 227	20 567	30 850	40 1134	1 28	3 85	6 170	6 170	0.050 (1.27)				0.050 (1.27)				-	-	-	-
BB	8 227	20 567	30 850	40 1134	1 28	3 85	6 170	6 170	0.050 (1.27)				0.050 (1.27)				-	-	-	-
J0	5 142	20 567	30 850	40 1134	1 28	3 85	6 170	6 170	0.050 (1.27)				0.187 (4.75)				-	-	-	-
L0	3 85	12 340	18 510	22 624	0.5 14	1 28	2 56.7	2 56.7	0.281 (7.14)				0.062 (1.57)				0.312 (7.92)			
P0	8 227	20 567	30 850	40 1134	1 28	3 85	6 170	6 170	0.050 (1.27)				0.050 (1.27)				-	-	-	-
Q0	5 142	20 567	30 850	40 1134	1 28	3 85	6 170	6 170	0.050 (1.27)				0.050 (1.27)				-	-	-	-
T0	1.5 42.5	4 113	6 170	10 283	0.3 8.5	0.5 14	1 28	1 28	0.312 (7.92)				0.187 (4.75)				0.312 (7.92)			
W0	3 85	12 340	18 510	22 624	0.5 14	1 28	2 56.7	2 56.7	0.281 (7.14)				0.062 (1.57)				0.718 (18.24)			

Note: For basic switch operating forces, see page 3.

### Terminations

#### 4A 0.250" Quick Connect



Note: Terminals can be supplied at various angles. Other terminal styles can be supplied for special applications. Consult Customer Service Center for special requirements.

### Circuitry

**C** DT (Double Throw, Normally Closed & Normally Open)

**W** ST N.C. (Single Throw, Normally Closed)

**Y** ST N.O. (Single Throw, Normally Open)

Note: To select number of poles, see No. Poles section, pages 2-3.

## Looking for pricing, stock, or lifecycle information?

Click below to explore more details on WIN SOURCE:

- ⊖ [View ASKHC2A04AC](#) on WIN SOURCE
- ⊖ [C&K Components](#) Information

## Optimize Your Supply Chain with WIN SOURCE Solutions

- ✓ Global Sourcing Solution
- ✓ Obsolete Management
- ✓ Cost Control Management
- ✓ Shortage Management
- ✓ Alternative Solution
- ✓ Excess Inventory Management