



**THE DATASHEET OF
PL8207**



SMT COMMON MODE CHOKES

SLIC Series

Ruggedized



iNRCORE FAMILY OF BRANDS

- ⊗ Dielectric Strength: 1500 VRMS
- ⊗ Designed for DC/DC converters
- ⊗ Operating & Storage Temperature: -55°C to +130°C
- ⊗ Lead Finish: Sn63/Pb37
- ⊗ Moisture Sensitivity Level: 1

Electrical Specifications @ 25°C

Part Number	Inductance 10KHz, 30mV (1-2) ($\mu\text{H} \pm 35\%$)	Irated (A)	DCR (1-2) & (3-4) (m Ω MAX)	Package	REFERENCE ONLY			
					Impedance Curve	Weight (grams MAX)	Tube QTY	Reel QTY
PL8200	470	14	8	HCCI-80-1	9	17.5	20	75
PL8201	630	11.6	10	HCCI-80-1	7	17.1	20	75
PL8202	810	9.70	14	HCCI-80-1	9	15.9	20	75
PL8203	534	7.20	15	HCCI-68	8	8.8	20	100
PL8204	590	5.60	21	LCCI-50-1	7	6.0	30	200
PL8205	768	4.70	40	LCCI-50-1	6	5.7	30	200
PL8206	225	3.30	60	LCCI-50-1	5	5.6	30	200
PL8207	1320	3.30	60	LCCI-50-1	4	5.3	30	200
PL8208	1470	2.80	80	LCCI-50-1	3	5.3	30	200
PL8209	880	1.63	110	Polecat	2	2.0	40	500
PL8210	1170	1.22	200	Polecat	1	2.0	40	500
PL8211	10040	1.40	210	LCCI-50-1	10	5.4	30	200
PL8212	1125	1.80	55	Polecat	11	2.2	40	500
PL8213	800	3.00	30	Polecat	12	3.0	40	300
PL8214	382.5	3.30	18	Polecat	13	2.2	40	200
PL8215	536	3.80	17.1	LCCI-37	14	3.0	30	200
PL8216	280	4.00	13.2	Polecat	15	2.0	40	500
PL8217	486	4.20	16	LCCI-44LP-1	16	3.8	35	300
PL8218	130	5.00	6.75	Polecat	17	2.0	40	500
PL8219	96	6.00	4.30	Polecat	18	2.2	40	500
PL8220	400	6.00	9.40	LCCI-44LP-2	19	4.3	35	200
PL8221	61	7.00	2.90	Polecat	20	2.2	40	500
PL8222	484	8.00	7.70	LCCI-50-2	21	6.4	30	200
PL8223	1030	9.00	9.75	HCCI-80-2	22	17.3	20	75
PL8224	215	10	3.75	Makeni-1	23	7.5	25	150
PL8225	95	12.5	3.00	LCCI-50-2	24	5.0	30	200
PL8226	117	14	1.95	Makeni-2	25	7.5	25	150
PL8227	500	16	4.25	HCCI-80-1	26	19.8	20	75
PL8228	380	20	4.10	HCCI-80-1	27	17.3	20	75

NOTES:

1. Add suffix "NL" for RoHS compliant version; i.e. PL8200 becomes PL8200NL.
2. For Tape & Reel packaging, add "T" suffix at the end of the part number: i.e. PL8200T.
3. The current rating (Irated) is based upon the temperature rise of the component and represents the rms current, which will cause a typical temperature rise of 55°C with 50LFM forced cooling.
4. The temperature of the component (ambient plus temperature rise) must be within the stated operating temperature range.



Performance warranty of products offered on this data sheet is limited to the parameters specified. Data is subject to change without notice. Other brand and product names mentioned herein may be trademarks or registered trademarks of their respective owners. © Copyright, 2023. iNRCORE, LLC. All rights reserved.

M108.P (20APR23)

Impedance Curves

(REFERENCE ONLY)

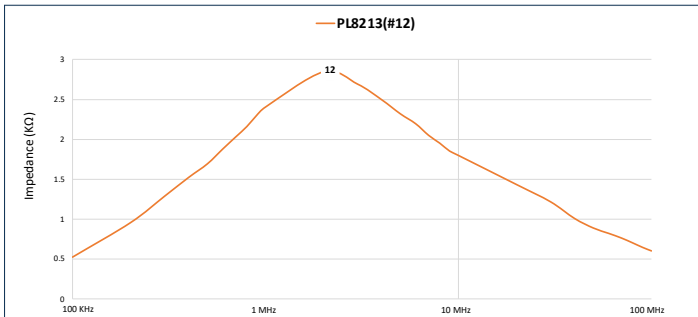
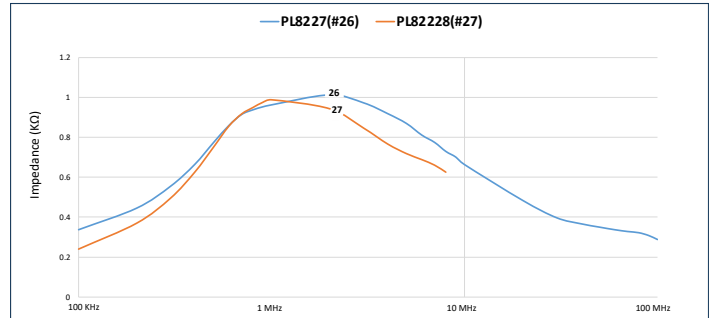
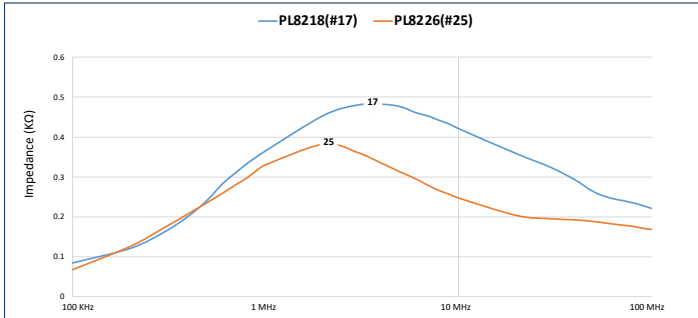
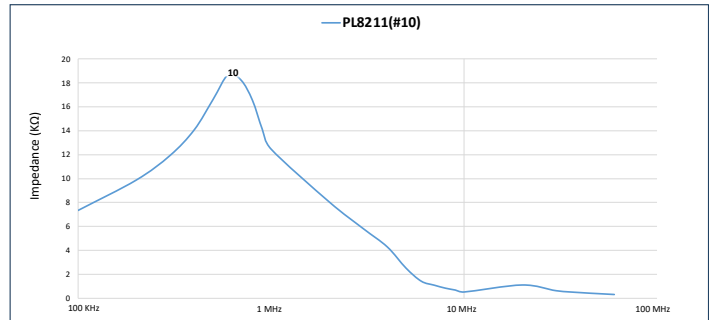
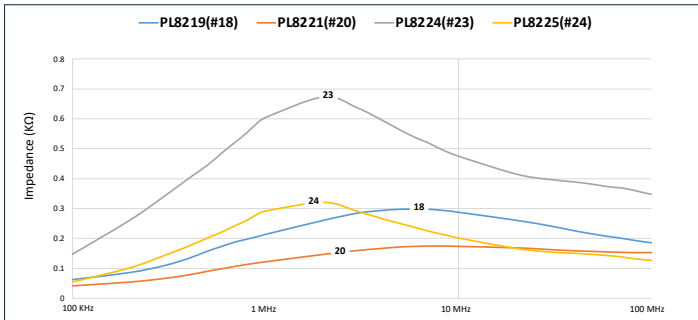
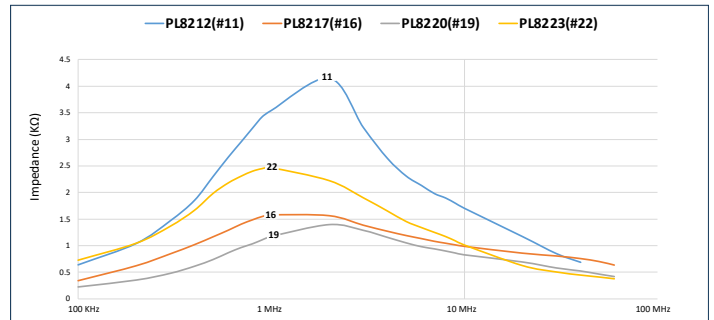
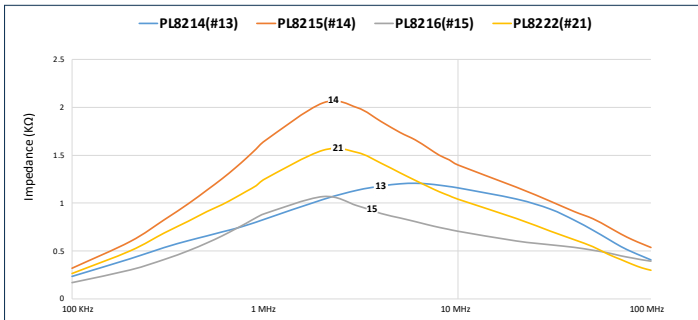
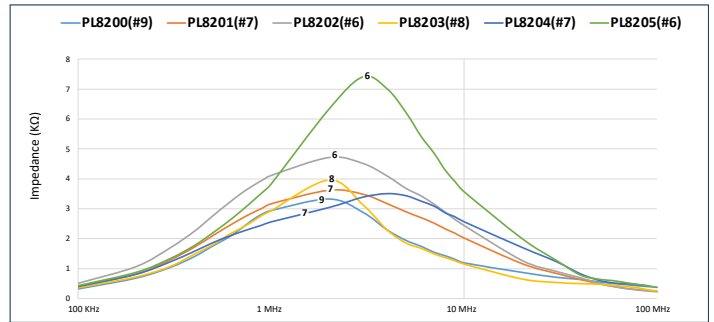
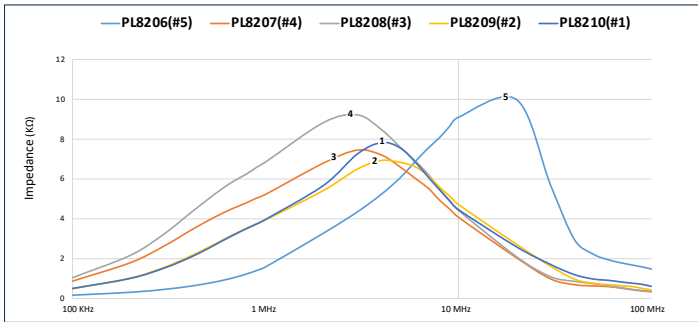

SMT COMMON MODE CHOKES

SLIC Series

Ruggedized

Mechanicals

Electrical Schematic

LCCI-50-1: PL8204/05/06/07/08/11

Dimensions: inch [mm]
Tolerance (unless otherwise specified): ±0.010 [0.25]

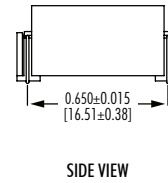
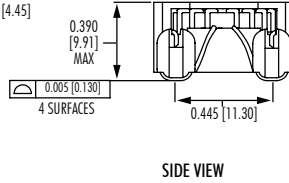
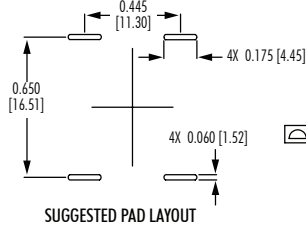
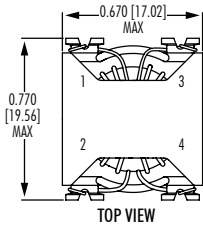
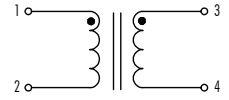

Mechanicals

Electrical Schematic

LCCI-50-2: PL8222, PL8225

Dimensions: inch [mm]
Tolerance (unless otherwise specified): ±0.010 [0.25]

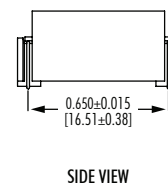
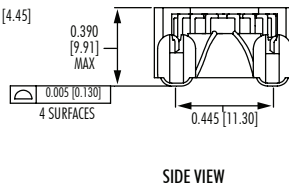
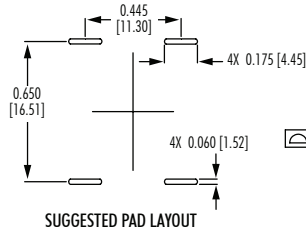
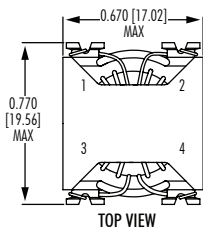
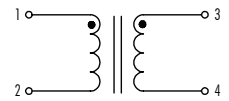

Mechanicals

Electrical Schematic

LCCI-44LP-1: PL8217

Dimensions: inch [mm]
Tolerance (unless otherwise specified): ±0.010 [0.25]

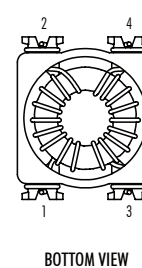
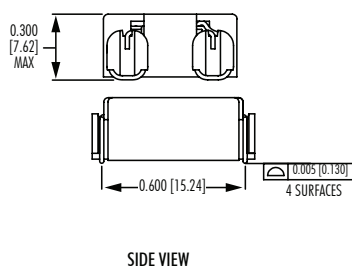
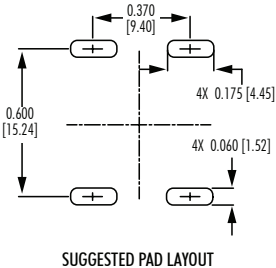
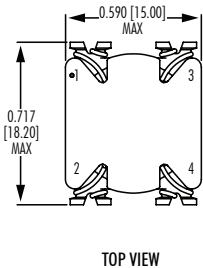
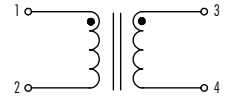

Mechanicals

Electrical Schematic

LCCI-44LP-2: PL8220

Dimensions: inch [mm]
Tolerance (unless otherwise specified): ±0.010 [0.25]

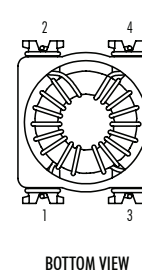
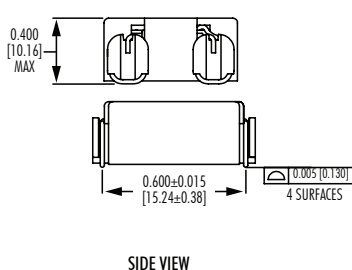
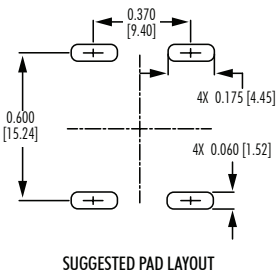
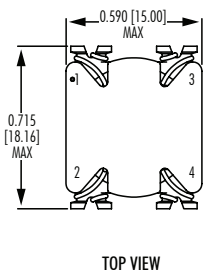
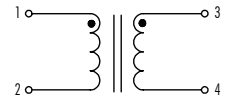

SMT COMMON MODE CHOKES

SLIC Series

Ruggedized

Mechanicals

Electrical Schematic

HCCI-80-1: PL8200/01/02/27/28

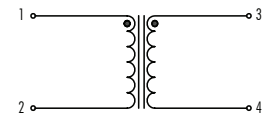
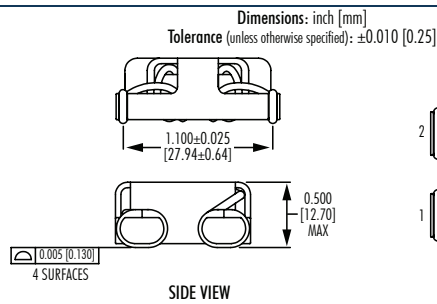
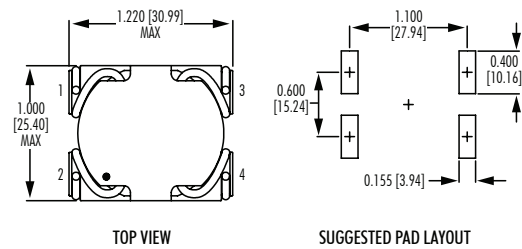

Mechanicals

Electrical Schematic

HCCI-80-2: PL8223

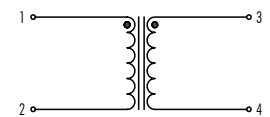
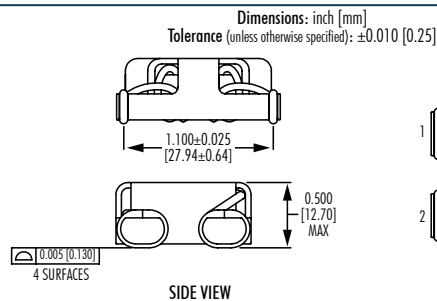
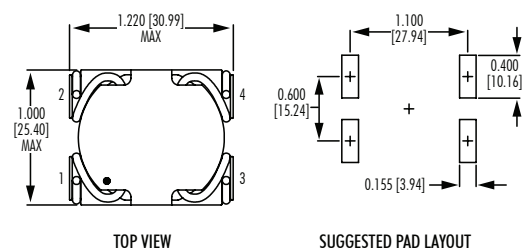

Mechanicals

POLECAT

Dimensions: inch [mm]
Tolerance (unless otherwise specified): ± 0.010 [0.25]

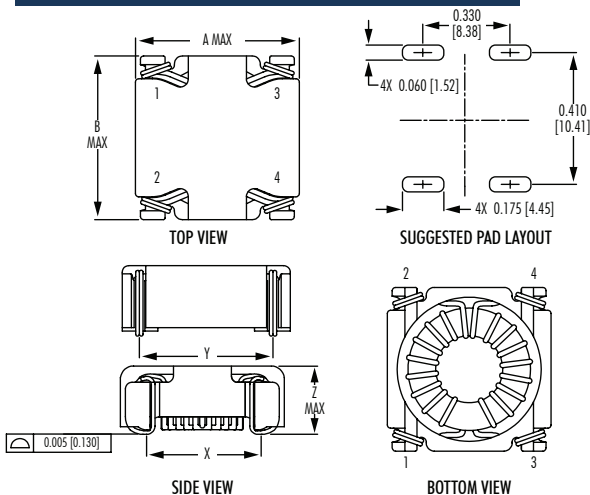

Electrical Schematic

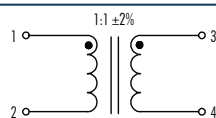

POLECAT DIMENSIONS

Part Number	A	B	X	Y	Z
PL8209	13.0	13.0	8.4	10.4	5.5
PL8210	13.0	13.0	8.4	10.4	5.5
PL8212	12.7	13.2	8.4	10.4	5.6
PL8213	13.0	13.0	8.4	10.4	8.6
PL8214	13.0	13.0	8.4	10.4	5.6
PL8216	13.0	13.0	8.4	10.4	5.6
PL8218	13.2	13.2	8.6	10.7	5.6
PL8219	13.2	13.2	8.6	10.7	5.6
PL8221	13.5	13.5	8.6	10.7	5.6



SMT COMMON MODE CHOKES

SLIC Series

Ruggedized

LCCI-37: PL8215

Mechanicals

Dimensions: inch [mm]
Tolerance (unless otherwise specified): ± 0.010 [0.25]

Electrical Schematic

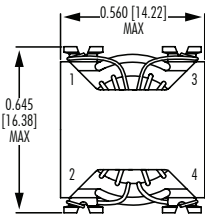

TOP VIEW

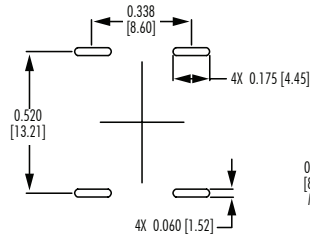

SUGGESTED PAD LAYOUT

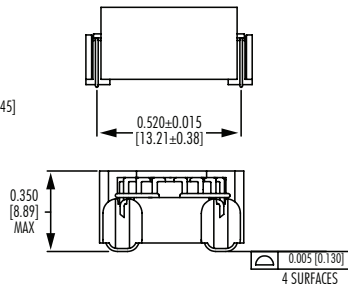

SIDE VIEW

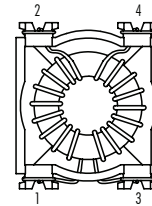

BOTTOM VIEW

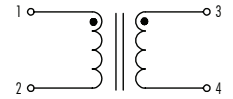

HCCI-68: PL8203

Mechanicals

Dimensions: inch [mm]
Tolerance (unless otherwise specified): ± 0.010 [0.25]

Electrical Schematic

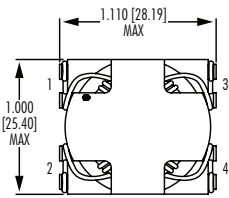

TOP VIEW

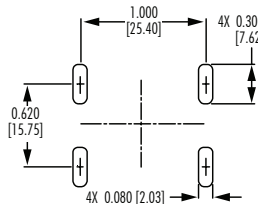

SUGGESTED PAD LAYOUT

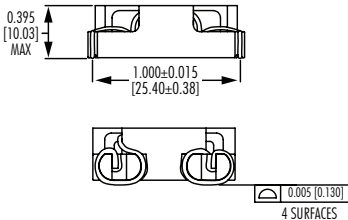

SIDE VIEW

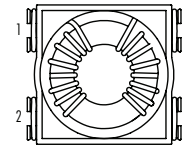

BOTTOM VIEW

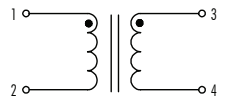

MAKENI-1: PL8224

Mechanicals

Dimensions: inch [mm]
Tolerance (unless otherwise specified): ± 0.010 [0.25]

Electrical Schematic

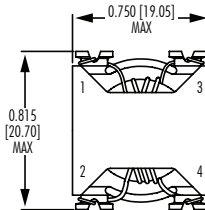

TOP VIEW

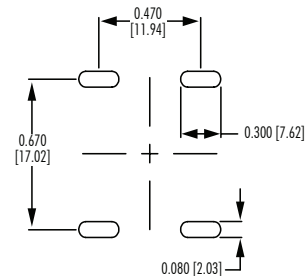

SUGGESTED PAD LAYOUT

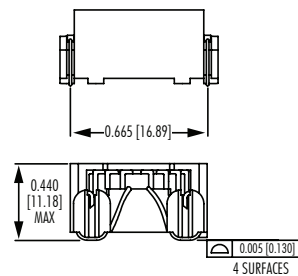

SIDE VIEW

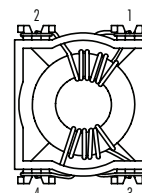

BOTTOM VIEW

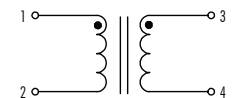

MAKENI-2: PL8226

Mechanicals

Dimensions: inch [mm]
Tolerance (unless otherwise specified): ± 0.010 [0.25]

Electrical Schematic

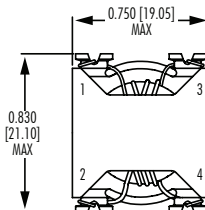

TOP VIEW

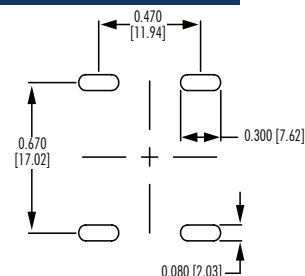

SUGGESTED PAD LAYOUT

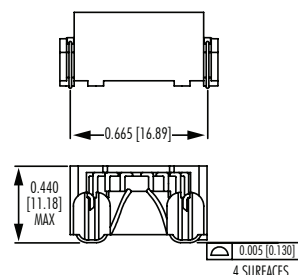

SIDE VIEW

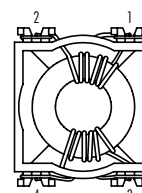

BOTTOM VIEW

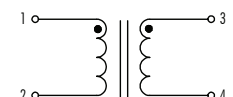

SMT COMMON MODE CHOKES

SLIC Series

Ruggedized

Recommended Reflow Profile (Based on J-STD-020D)

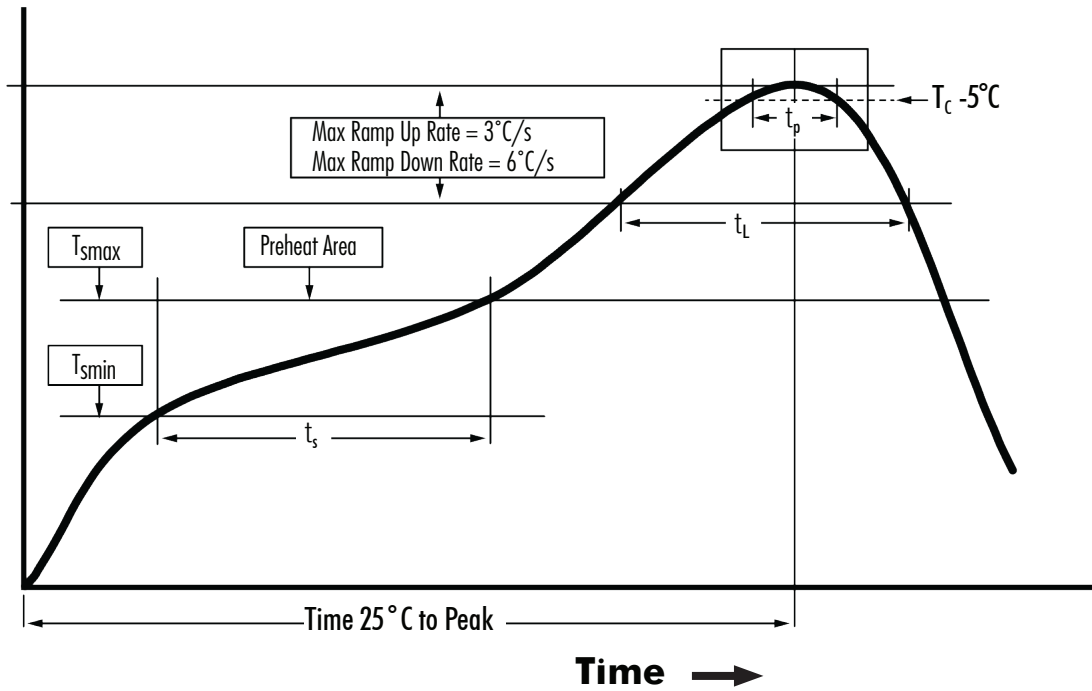

T_{smin} (°C)	T_{smax} (°C)	T_L (°C)	T_p (°C MAX)	t_s (s)	t_L (s)	t_p (s MAX)	Ramp-up rate (T_L to T_p)	Ramp-down rate (T_p to T_L)	Time 25°C to peak temperature (s MAX)
Tin/Lead Profile									
100	150	183	220	60 - 120	60 - 150	20	3°C/s MAX	6°C/s MAX	360
Non-Lead Profile									
150	200	217	245	60 - 120	60 - 150	30	3°C/s MAX	6°C/s MAX	480

NOTES:

1. All temperatures measured on the package leads.
2. Maximum number of reflow cycles not to exceed 2.



iNRCORE, LLC
311 Sinclair Road, Bristol, PA 19007-6812 USA
Tel: +1.215.781.6400 Fax: +1.215.781.6430

www.iNRCORE.com

M108.P (20APR23)

Performance warranty of products offered on this data sheet is limited to the parameters specified. Data is subject to change without notice. Other brand and product names mentioned herein may be trademarks or registered trademarks of their respective owners. © Copyright, 2023. iNRCORE, LLC. All rights reserved.

Looking for pricing, stock, or lifecycle information?

Click below to explore more details on WIN SOURCE:

 [View PL8207 on WIN SOURCE](#)

 [iNRCORE, LLC Information](#)

Optimize Your Supply Chain with WIN SOURCE Solutions

-  Global Sourcing Solution
-  Obsolete Management
-  Cost Control Management
-  Shortage Management
-  Alternative Solution
-  Excess Inventory Management