

Reference Specification

Leaded MLCC for Automotive (Powertrain/Safety)
RCE Series

Product specifications in this catalog are as of Apr. 2025, and are subject to change or obsolescence without notice.
Please consult the approval sheet before ordering. Please read rating and Cautions first.

[CONTENTS]

- **Scope**
- **Rating**
- **Marking**
- **Part number list**
- **Specification**
- **Packing specification**
- **Taping specification**
- ** CAUTION & NOTICE & NOTE**

1. Scope

This product specification is applied to Leaded MLCC RCE series.

1. Specific applications:

- Automotive powertrain/safety equipment: Products that can be used for automotive equipment related to running, turning, stopping, safety devices, etc., or equipment whose structure, equipment, and performance are legally required to meet technical standards for safety assurance or environmental protection.
- Automotive infotainment/comfort equipment: Products that can be used for automotive equipment such as car navigation systems and car audio systems that do not directly relate to human life and whose structure, equipment, and performance are not specifically required by law to meet technical standards for safety assurance or environmental protection.
- Medial Equipment [GHTF A/B/C] except for Implant Equipment: Products suitable for use in medical devices designated under the GHTF international classifications as Class A or Class B (the functions of which are not directly involved in protection of human life or property) or in medical devices other than implants designated under the GHTF international classifications as Class C (the malfunctioning of which is considered to pose a comparatively high risk to the human body).

2.Unsuitable Application: Applications listed in "Limitation of applications" in this product specification.
 WE DISCLAIM ANY LOSS AND DAMAGES ARISING FROM OR IN CONNECTION WITH
 THE PRODUCTS INCLUDING BUT NOT LIMITED TO THE CASE SUCH LOSS AND DAMAGES
 CAUSED BY THE UNEXPECTED ACCIDENT,
 IN EVENT THAT THE PRODUCT IS APPLIED FOR THE PURPOSE WHICH IS SPECIFIED ABOVE
 AS THE UNSUITABLE APPLICATION FOR THE PRODUCT.

2. Rating

• Part Number Configuration

ex.)

RCE	5C	1H	104	J	2	K1	H03	B
Series	Temperature Characteristics	Rated Voltage	Capacitance	Capacitance Tolerance	Dimension (LxW)	Lead Style	Individual Specification	Package

• Temperature Characteristics

Code	Temp. Char.	Temp. Range	Temp.coef.	Standard Temp.	Operating Temp. Range
5C	C0G (EIA code)	-55~25°C	0+30/-72ppm/°C	25°C	-55~125°C
		25~125°C	0+/-30ppm/°C		

• Rated Voltage

Code	Rated voltage
1H	DC50V
2A	DC100V

• Capacitance

The first two digits denote significant figures ; the last digit denotes the multiplier of 10 in pF. If there is a decimal point, it is expressed by the capital letter "R". In this case, all figures are significant digits.

ex.) In case of 104 .
 $10 \times 10^4 = 100000 \text{ pF}$
 In case of 9R0 .
 9.0 pF

Reference only

• Capacitance Tolerance

Code	Capacitance Tolerance
C	+/-0.25pF
D	+/-0.5pF
J	+/-5%

• Dimension (LxW)

Please refer to [Part number list].

• Lead Style

*Lead wire is "solder coated CP wire".

Code	Lead Style	Lead spacing (mm)
A2	Straight type	2.5+/-0.8
DB	Straight taping type	2.5+0.4/-0.2
K1	Inside crimp type	5.0+/-0.8
M1	Inside crimp taping type	5.0+0.6/-0.2

• Individual Specification

Murata's control code.

Please refer to [Part number list].



• Package

Code	Package
A	Taping type of Ammo
B	Bulk type

3. Marking

- Temp. char. : Letter code : A (C0G Char.)
 Capacitance : Actual numbers (Less than 100pF)
 3 digit numbers (100pF and over)
 Capacitance tolerance : Code
 Rated voltage : Letter code : 5 (DC50V. Except dimension code : 0,1)
 Letter code : 1 (DC100V. Except dimension code : 0,1)
 Company name code : Abbreviation :  (Except dimension code : 0,1)

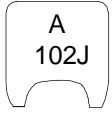
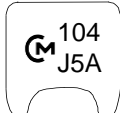
(Ex.)

Dimension code \ Rated voltage	DC50V	DC100V
	0,1	
2		

4. Part number list

• Straight Long
(Lead Style:A2)

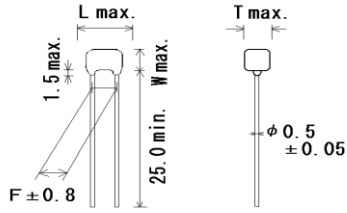

Unit : mm

Customer Part Number	Murata Part Number	T.C.	DC Rated Volt. (V)	Cap.	Cap. Tol.	Dimension (mm)					Dimension (LxW) Lead Style	Pack qty. (pcs)
						L	W	W1	F	T		
	RCE5C1H1R0C0A2H03B	C0G	50	1pF	±0.25pF	3.6	3.5	-	2.5	2.5	0A2	500
	RCE5C1H2R0C0A2H03B	C0G	50	2pF	±0.25pF	3.6	3.5	-	2.5	2.5	0A2	500
	RCE5C1H3R0C0A2H03B	C0G	50	3pF	±0.25pF	3.6	3.5	-	2.5	2.5	0A2	500
	RCE5C1H4R0C0A2H03B	C0G	50	4pF	±0.25pF	3.6	3.5	-	2.5	2.5	0A2	500
	RCE5C1H5R0C0A2H03B	C0G	50	5pF	±0.25pF	3.6	3.5	-	2.5	2.5	0A2	500
	RCE5C1H6R0D0A2H03B	C0G	50	6pF	±0.5pF	3.6	3.5	-	2.5	2.5	0A2	500
	RCE5C1H7R0D0A2H03B	C0G	50	7pF	±0.5pF	3.6	3.5	-	2.5	2.5	0A2	500
	RCE5C1H8R0D0A2H03B	C0G	50	8pF	±0.5pF	3.6	3.5	-	2.5	2.5	0A2	500
	RCE5C1H9R0D0A2H03B	C0G	50	9pF	±0.5pF	3.6	3.5	-	2.5	2.5	0A2	500
	RCE5C1H100J0A2H03B	C0G	50	10pF	±5%	3.6	3.5	-	2.5	2.5	0A2	500
	RCE5C1H120J0A2H03B	C0G	50	12pF	±5%	3.6	3.5	-	2.5	2.5	0A2	500
	RCE5C1H150J0A2H03B	C0G	50	15pF	±5%	3.6	3.5	-	2.5	2.5	0A2	500
	RCE5C1H180J0A2H03B	C0G	50	18pF	±5%	3.6	3.5	-	2.5	2.5	0A2	500
	RCE5C1H220J0A2H03B	C0G	50	22pF	±5%	3.6	3.5	-	2.5	2.5	0A2	500
	RCE5C1H270J0A2H03B	C0G	50	27pF	±5%	3.6	3.5	-	2.5	2.5	0A2	500
	RCE5C1H330J0A2H03B	C0G	50	33pF	±5%	3.6	3.5	-	2.5	2.5	0A2	500
	RCE5C1H390J0A2H03B	C0G	50	39pF	±5%	3.6	3.5	-	2.5	2.5	0A2	500
	RCE5C1H470J0A2H03B	C0G	50	47pF	±5%	3.6	3.5	-	2.5	2.5	0A2	500
	RCE5C1H560J0A2H03B	C0G	50	56pF	±5%	3.6	3.5	-	2.5	2.5	0A2	500
	RCE5C1H680J0A2H03B	C0G	50	68pF	±5%	3.6	3.5	-	2.5	2.5	0A2	500
	RCE5C1H820J0A2H03B	C0G	50	82pF	±5%	3.6	3.5	-	2.5	2.5	0A2	500
	RCE5C1H101J0A2H03B	C0G	50	100pF	±5%	3.6	3.5	-	2.5	2.5	0A2	500
	RCE5C1H121J0A2H03B	C0G	50	120pF	±5%	3.6	3.5	-	2.5	2.5	0A2	500
	RCE5C1H151J0A2H03B	C0G	50	150pF	±5%	3.6	3.5	-	2.5	2.5	0A2	500
	RCE5C1H181J0A2H03B	C0G	50	180pF	±5%	3.6	3.5	-	2.5	2.5	0A2	500
	RCE5C1H221J0A2H03B	C0G	50	220pF	±5%	3.6	3.5	-	2.5	2.5	0A2	500
	RCE5C1H271J0A2H03B	C0G	50	270pF	±5%	3.6	3.5	-	2.5	2.5	0A2	500
	RCE5C1H331J0A2H03B	C0G	50	330pF	±5%	3.6	3.5	-	2.5	2.5	0A2	500
	RCE5C1H391J0A2H03B	C0G	50	390pF	±5%	3.6	3.5	-	2.5	2.5	0A2	500
	RCE5C1H471J0A2H03B	C0G	50	470pF	±5%	3.6	3.5	-	2.5	2.5	0A2	500
	RCE5C1H561J0A2H03B	C0G	50	560pF	±5%	3.6	3.5	-	2.5	2.5	0A2	500
	RCE5C1H681J0A2H03B	C0G	50	680pF	±5%	3.6	3.5	-	2.5	2.5	0A2	500
	RCE5C1H821J0A2H03B	C0G	50	820pF	±5%	3.6	3.5	-	2.5	2.5	0A2	500
	RCE5C1H102J0A2H03B	C0G	50	1000pF	±5%	3.6	3.5	-	2.5	2.5	0A2	500
	RCE5C1H122J0A2H03B	C0G	50	1200pF	±5%	3.6	3.5	-	2.5	2.5	0A2	500
	RCE5C1H152J0A2H03B	C0G	50	1500pF	±5%	3.6	3.5	-	2.5	2.5	0A2	500
	RCE5C1H182J0A2H03B	C0G	50	1800pF	±5%	3.6	3.5	-	2.5	2.5	0A2	500
	RCE5C1H222J0A2H03B	C0G	50	2200pF	±5%	3.6	3.5	-	2.5	2.5	0A2	500
	RCE5C1H272J0A2H03B	C0G	50	2700pF	±5%	3.6	3.5	-	2.5	2.5	0A2	500
	RCE5C1H332J0A2H03B	C0G	50	3300pF	±5%	3.6	3.5	-	2.5	2.5	0A2	500

• Straight Long
(Lead Style:A2)

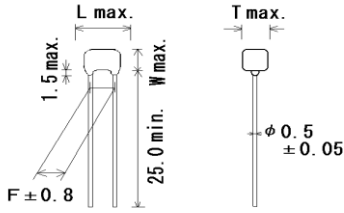

Unit : mm

Customer Part Number	Murata Part Number	T.C.	DC Rated Volt. (V)	Cap.	Cap. Tol.	Dimension (mm)					Dimension (LxW) Lead Style	Pack qty. (pcs)
						L	W	W1	F	T		
	RCE5C1H392J0A2H03B	C0G	50	3900pF	±5%	3.6	3.5	-	2.5	2.5	0A2	500
	RCE5C1H472J1A2H03B	C0G	50	4700pF	±5%	4.0	3.5	-	2.5	2.5	1A2	500
	RCE5C1H562J1A2H03B	C0G	50	5600pF	±5%	4.0	3.5	-	2.5	2.5	1A2	500
	RCE5C1H682J1A2H03B	C0G	50	6800pF	±5%	4.0	3.5	-	2.5	2.5	1A2	500
	RCE5C1H822J1A2H03B	C0G	50	8200pF	±5%	4.0	3.5	-	2.5	2.5	1A2	500
	RCE5C1H103J1A2H03B	C0G	50	10000pF	±5%	4.0	3.5	-	2.5	2.5	1A2	500
	RCE5C1H123J1A2H03B	C0G	50	12000pF	±5%	4.0	3.5	-	2.5	2.5	1A2	500
	RCE5C1H153J1A2H03B	C0G	50	15000pF	±5%	4.0	3.5	-	2.5	2.5	1A2	500
	RCE5C1H183J1A2H03B	C0G	50	18000pF	±5%	4.0	3.5	-	2.5	2.5	1A2	500
	RCE5C1H223J1A2H03B	C0G	50	22000pF	±5%	4.0	3.5	-	2.5	2.5	1A2	500
	RCE5C1H273J2A2H03B	C0G	50	27000pF	±5%	5.5	4.0	-	2.5	3.15	2A2	500
	RCE5C1H333J2A2H03B	C0G	50	33000pF	±5%	5.5	4.0	-	2.5	3.15	2A2	500
	RCE5C1H393J2A2H03B	C0G	50	39000pF	±5%	5.5	4.0	-	2.5	3.15	2A2	500
	RCE5C1H473J2A2H03B	C0G	50	47000pF	±5%	5.5	4.0	-	2.5	3.15	2A2	500
	RCE5C1H563J2A2H03B	C0G	50	56000pF	±5%	5.5	4.0	-	2.5	3.15	2A2	500
	RCE5C1H683J2A2H03B	C0G	50	68000pF	±5%	5.5	4.0	-	2.5	3.15	2A2	500
	RCE5C1H823J2A2H03B	C0G	50	82000pF	±5%	5.5	4.0	-	2.5	3.15	2A2	500
	RCE5C1H104J2A2H03B	C0G	50	0.1μF	±5%	5.5	4.0	-	2.5	3.15	2A2	500
	RCE5C2A1R0C0A2H03B	C0G	100	1pF	±0.25pF	3.6	3.5	-	2.5	2.5	0A2	500
	RCE5C2A2R0C0A2H03B	C0G	100	2pF	±0.25pF	3.6	3.5	-	2.5	2.5	0A2	500
	RCE5C2A3R0C0A2H03B	C0G	100	3pF	±0.25pF	3.6	3.5	-	2.5	2.5	0A2	500
	RCE5C2A4R0C0A2H03B	C0G	100	4pF	±0.25pF	3.6	3.5	-	2.5	2.5	0A2	500
	RCE5C2A5R0C0A2H03B	C0G	100	5pF	±0.25pF	3.6	3.5	-	2.5	2.5	0A2	500
	RCE5C2A6R0D0A2H03B	C0G	100	6pF	±0.5pF	3.6	3.5	-	2.5	2.5	0A2	500
	RCE5C2A7R0D0A2H03B	C0G	100	7pF	±0.5pF	3.6	3.5	-	2.5	2.5	0A2	500
	RCE5C2A8R0D0A2H03B	C0G	100	8pF	±0.5pF	3.6	3.5	-	2.5	2.5	0A2	500
	RCE5C2A9R0D0A2H03B	C0G	100	9pF	±0.5pF	3.6	3.5	-	2.5	2.5	0A2	500
	RCE5C2A100J0A2H03B	C0G	100	10pF	±5%	3.6	3.5	-	2.5	2.5	0A2	500
	RCE5C2A120J0A2H03B	C0G	100	12pF	±5%	3.6	3.5	-	2.5	2.5	0A2	500
	RCE5C2A150J0A2H03B	C0G	100	15pF	±5%	3.6	3.5	-	2.5	2.5	0A2	500
	RCE5C2A180J0A2H03B	C0G	100	18pF	±5%	3.6	3.5	-	2.5	2.5	0A2	500
	RCE5C2A220J0A2H03B	C0G	100	22pF	±5%	3.6	3.5	-	2.5	2.5	0A2	500
	RCE5C2A270J0A2H03B	C0G	100	27pF	±5%	3.6	3.5	-	2.5	2.5	0A2	500
	RCE5C2A330J0A2H03B	C0G	100	33pF	±5%	3.6	3.5	-	2.5	2.5	0A2	500
	RCE5C2A390J0A2H03B	C0G	100	39pF	±5%	3.6	3.5	-	2.5	2.5	0A2	500
	RCE5C2A470J0A2H03B	C0G	100	47pF	±5%	3.6	3.5	-	2.5	2.5	0A2	500
	RCE5C2A560J0A2H03B	C0G	100	56pF	±5%	3.6	3.5	-	2.5	2.5	0A2	500
	RCE5C2A680J0A2H03B	C0G	100	68pF	±5%	3.6	3.5	-	2.5	2.5	0A2	500
	RCE5C2A820J0A2H03B	C0G	100	82pF	±5%	3.6	3.5	-	2.5	2.5	0A2	500
	RCE5C2A101J0A2H03B	C0G	100	100pF	±5%	3.6	3.5	-	2.5	2.5	0A2	500

- Straight Long
(Lead Style:A2)

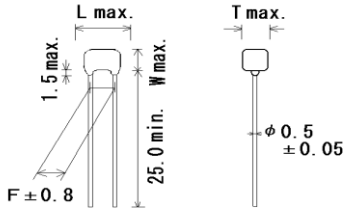

- Inside Crimp
(Lead Style:K*)

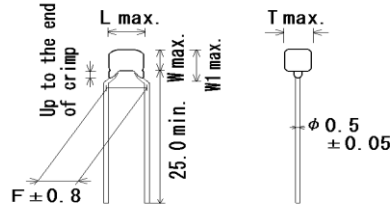

Unit : mm

Customer Part Number	Murata Part Number	T.C.	DC Rated Volt. (V)	Cap.	Cap. Tol.	Dimension (mm)					Dimension (LxW) Lead Style	Pack qty. (pcs)
						L	W	W1	F	T		
	RCE5C2A121J0A2H03B	C0G	100	120pF	±5%	3.6	3.5	-	2.5	2.5	0A2	500
	RCE5C2A151J0A2H03B	C0G	100	150pF	±5%	3.6	3.5	-	2.5	2.5	0A2	500
	RCE5C2A181J0A2H03B	C0G	100	180pF	±5%	3.6	3.5	-	2.5	2.5	0A2	500
	RCE5C2A221J0A2H03B	C0G	100	220pF	±5%	3.6	3.5	-	2.5	2.5	0A2	500
	RCE5C2A271J0A2H03B	C0G	100	270pF	±5%	3.6	3.5	-	2.5	2.5	0A2	500
	RCE5C2A331J0A2H03B	C0G	100	330pF	±5%	3.6	3.5	-	2.5	2.5	0A2	500
	RCE5C2A391J0A2H03B	C0G	100	390pF	±5%	3.6	3.5	-	2.5	2.5	0A2	500
	RCE5C2A471J0A2H03B	C0G	100	470pF	±5%	3.6	3.5	-	2.5	2.5	0A2	500
	RCE5C2A561J0A2H03B	C0G	100	560pF	±5%	3.6	3.5	-	2.5	2.5	0A2	500
	RCE5C2A681J0A2H03B	C0G	100	680pF	±5%	3.6	3.5	-	2.5	2.5	0A2	500
	RCE5C2A821J0A2H03B	C0G	100	820pF	±5%	3.6	3.5	-	2.5	2.5	0A2	500
	RCE5C2A102J0A2H03B	C0G	100	1000pF	±5%	3.6	3.5	-	2.5	2.5	0A2	500
	RCE5C2A122J0A2H03B	C0G	100	1200pF	±5%	3.6	3.5	-	2.5	2.5	0A2	500
	RCE5C2A152J0A2H03B	C0G	100	1500pF	±5%	3.6	3.5	-	2.5	2.5	0A2	500
	RCE5C2A182J1A2H03B	C0G	100	1800pF	±5%	4.0	3.5	-	2.5	2.5	1A2	500
	RCE5C2A222J1A2H03B	C0G	100	2200pF	±5%	4.0	3.5	-	2.5	2.5	1A2	500
	RCE5C2A272J1A2H03B	C0G	100	2700pF	±5%	4.0	3.5	-	2.5	2.5	1A2	500
	RCE5C2A332J1A2H03B	C0G	100	3300pF	±5%	4.0	3.5	-	2.5	2.5	1A2	500
	RCE5C2A392J2A2H03B	C0G	100	3900pF	±5%	5.5	4.0	-	2.5	3.15	2A2	500
	RCE5C2A472J2A2H03B	C0G	100	4700pF	±5%	5.5	4.0	-	2.5	3.15	2A2	500
	RCE5C2A562J2A2H03B	C0G	100	5600pF	±5%	5.5	4.0	-	2.5	3.15	2A2	500
	RCE5C2A682J2A2H03B	C0G	100	6800pF	±5%	5.5	4.0	-	2.5	3.15	2A2	500
	RCE5C2A822J2A2H03B	C0G	100	8200pF	±5%	5.5	4.0	-	2.5	3.15	2A2	500
	RCE5C2A103J2A2H03B	C0G	100	10000pF	±5%	5.5	4.0	-	2.5	3.15	2A2	500
	RCE5C1H1R0C0K1H03B	C0G	50	1pF	±0.25pF	3.6	3.5	6.0	5.0	2.5	0K1	500
	RCE5C1H2R0C0K1H03B	C0G	50	2pF	±0.25pF	3.6	3.5	6.0	5.0	2.5	0K1	500
	RCE5C1H3R0C0K1H03B	C0G	50	3pF	±0.25pF	3.6	3.5	6.0	5.0	2.5	0K1	500
	RCE5C1H4R0C0K1H03B	C0G	50	4pF	±0.25pF	3.6	3.5	6.0	5.0	2.5	0K1	500
	RCE5C1H5R0C0K1H03B	C0G	50	5pF	±0.25pF	3.6	3.5	6.0	5.0	2.5	0K1	500
	RCE5C1H6R0D0K1H03B	C0G	50	6pF	±0.5pF	3.6	3.5	6.0	5.0	2.5	0K1	500
	RCE5C1H7R0D0K1H03B	C0G	50	7pF	±0.5pF	3.6	3.5	6.0	5.0	2.5	0K1	500
	RCE5C1H8R0D0K1H03B	C0G	50	8pF	±0.5pF	3.6	3.5	6.0	5.0	2.5	0K1	500
	RCE5C1H9R0D0K1H03B	C0G	50	9pF	±0.5pF	3.6	3.5	6.0	5.0	2.5	0K1	500
	RCE5C1H100J0K1H03B	C0G	50	10pF	±5%	3.6	3.5	6.0	5.0	2.5	0K1	500
	RCE5C1H120J0K1H03B	C0G	50	12pF	±5%	3.6	3.5	6.0	5.0	2.5	0K1	500
	RCE5C1H150J0K1H03B	C0G	50	15pF	±5%	3.6	3.5	6.0	5.0	2.5	0K1	500
	RCE5C1H180J0K1H03B	C0G	50	18pF	±5%	3.6	3.5	6.0	5.0	2.5	0K1	500
	RCE5C1H220J0K1H03B	C0G	50	22pF	±5%	3.6	3.5	6.0	5.0	2.5	0K1	500
	RCE5C1H270J0K1H03B	C0G	50	27pF	±5%	3.6	3.5	6.0	5.0	2.5	0K1	500
	RCE5C1H330J0K1H03B	C0G	50	33pF	±5%	3.6	3.5	6.0	5.0	2.5	0K1	500

- Inside Crimp
(Lead Style:K*)

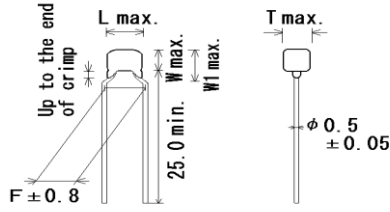

Unit : mm

Customer Part Number	Murata Part Number	T.C.	DC Rated Volt. (V)	Cap.	Cap. Tol.	Dimension (mm)					Dimension (LxW) Lead Style	Pack qty. (pcs)
						L	W	W1	F	T		
	RCE5C1H390J0K1H03B	C0G	50	39pF	±5%	3.6	3.5	6.0	5.0	2.5	0K1	500
	RCE5C1H470J0K1H03B	C0G	50	47pF	±5%	3.6	3.5	6.0	5.0	2.5	0K1	500
	RCE5C1H560J0K1H03B	C0G	50	56pF	±5%	3.6	3.5	6.0	5.0	2.5	0K1	500
	RCE5C1H680J0K1H03B	C0G	50	68pF	±5%	3.6	3.5	6.0	5.0	2.5	0K1	500
	RCE5C1H820J0K1H03B	C0G	50	82pF	±5%	3.6	3.5	6.0	5.0	2.5	0K1	500
	RCE5C1H101J0K1H03B	C0G	50	100pF	±5%	3.6	3.5	6.0	5.0	2.5	0K1	500
	RCE5C1H121J0K1H03B	C0G	50	120pF	±5%	3.6	3.5	6.0	5.0	2.5	0K1	500
	RCE5C1H151J0K1H03B	C0G	50	150pF	±5%	3.6	3.5	6.0	5.0	2.5	0K1	500
	RCE5C1H181J0K1H03B	C0G	50	180pF	±5%	3.6	3.5	6.0	5.0	2.5	0K1	500
	RCE5C1H221J0K1H03B	C0G	50	220pF	±5%	3.6	3.5	6.0	5.0	2.5	0K1	500
	RCE5C1H271J0K1H03B	C0G	50	270pF	±5%	3.6	3.5	6.0	5.0	2.5	0K1	500
	RCE5C1H331J0K1H03B	C0G	50	330pF	±5%	3.6	3.5	6.0	5.0	2.5	0K1	500
	RCE5C1H391J0K1H03B	C0G	50	390pF	±5%	3.6	3.5	6.0	5.0	2.5	0K1	500
	RCE5C1H471J0K1H03B	C0G	50	470pF	±5%	3.6	3.5	6.0	5.0	2.5	0K1	500
	RCE5C1H561J0K1H03B	C0G	50	560pF	±5%	3.6	3.5	6.0	5.0	2.5	0K1	500
	RCE5C1H681J0K1H03B	C0G	50	680pF	±5%	3.6	3.5	6.0	5.0	2.5	0K1	500
	RCE5C1H821J0K1H03B	C0G	50	820pF	±5%	3.6	3.5	6.0	5.0	2.5	0K1	500
	RCE5C1H102J0K1H03B	C0G	50	1000pF	±5%	3.6	3.5	6.0	5.0	2.5	0K1	500
	RCE5C1H122J0K1H03B	C0G	50	1200pF	±5%	3.6	3.5	6.0	5.0	2.5	0K1	500
	RCE5C1H152J0K1H03B	C0G	50	1500pF	±5%	3.6	3.5	6.0	5.0	2.5	0K1	500
	RCE5C1H182J0K1H03B	C0G	50	1800pF	±5%	3.6	3.5	6.0	5.0	2.5	0K1	500
	RCE5C1H222J0K1H03B	C0G	50	2200pF	±5%	3.6	3.5	6.0	5.0	2.5	0K1	500
	RCE5C1H272J0K1H03B	C0G	50	2700pF	±5%	3.6	3.5	6.0	5.0	2.5	0K1	500
	RCE5C1H332J0K1H03B	C0G	50	3300pF	±5%	3.6	3.5	6.0	5.0	2.5	0K1	500
	RCE5C1H392J0K1H03B	C0G	50	3900pF	±5%	3.6	3.5	6.0	5.0	2.5	0K1	500
	RCE5C1H472J1K1H03B	C0G	50	4700pF	±5%	4.0	3.5	5.0	5.0	2.5	1K1	500
	RCE5C1H562J1K1H03B	C0G	50	5600pF	±5%	4.0	3.5	5.0	5.0	2.5	1K1	500
	RCE5C1H682J1K1H03B	C0G	50	6800pF	±5%	4.0	3.5	5.0	5.0	2.5	1K1	500
	RCE5C1H822J1K1H03B	C0G	50	8200pF	±5%	4.0	3.5	5.0	5.0	2.5	1K1	500
	RCE5C1H103J1K1H03B	C0G	50	10000pF	±5%	4.0	3.5	5.0	5.0	2.5	1K1	500
	RCE5C1H123J1K1H03B	C0G	50	12000pF	±5%	4.0	3.5	5.0	5.0	2.5	1K1	500
	RCE5C1H153J1K1H03B	C0G	50	15000pF	±5%	4.0	3.5	5.0	5.0	2.5	1K1	500
	RCE5C1H183J1K1H03B	C0G	50	18000pF	±5%	4.0	3.5	5.0	5.0	2.5	1K1	500
	RCE5C1H223J1K1H03B	C0G	50	22000pF	±5%	4.0	3.5	5.0	5.0	2.5	1K1	500
	RCE5C1H273J2K1H03B	C0G	50	27000pF	±5%	5.5	4.0	6.0	5.0	3.15	2K1	500
	RCE5C1H333J2K1H03B	C0G	50	33000pF	±5%	5.5	4.0	6.0	5.0	3.15	2K1	500
	RCE5C1H393J2K1H03B	C0G	50	39000pF	±5%	5.5	4.0	6.0	5.0	3.15	2K1	500
	RCE5C1H473J2K1H03B	C0G	50	47000pF	±5%	5.5	4.0	6.0	5.0	3.15	2K1	500
	RCE5C1H563J2K1H03B	C0G	50	56000pF	±5%	5.5	4.0	6.0	5.0	3.15	2K1	500
	RCE5C1H683J2K1H03B	C0G	50	68000pF	±5%	5.5	4.0	6.0	5.0	3.15	2K1	500

- Inside Crimp
(Lead Style:K*)

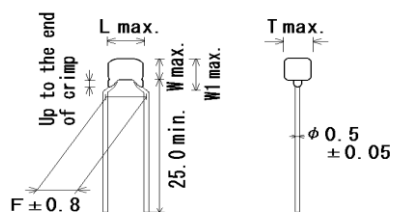

Unit : mm

Customer Part Number	Murata Part Number	T.C.	DC Rated Volt. (V)	Cap.	Cap. Tol.	Dimension (mm)					Dimension (LxW) Lead Style	Pack qty. (pcs)
						L	W	W1	F	T		
	RCE5C1H823J2K1H03B	C0G	50	82000pF	±5%	5.5	4.0	6.0	5.0	3.15	2K1	500
	RCE5C1H104J2K1H03B	C0G	50	0.1μF	±5%	5.5	4.0	6.0	5.0	3.15	2K1	500
	RCE5C2A1R0C0K1H03B	C0G	100	1pF	±0.25pF	3.6	3.5	6.0	5.0	2.5	0K1	500
	RCE5C2A2R0C0K1H03B	C0G	100	2pF	±0.25pF	3.6	3.5	6.0	5.0	2.5	0K1	500
	RCE5C2A3R0C0K1H03B	C0G	100	3pF	±0.25pF	3.6	3.5	6.0	5.0	2.5	0K1	500
	RCE5C2A4R0C0K1H03B	C0G	100	4pF	±0.25pF	3.6	3.5	6.0	5.0	2.5	0K1	500
	RCE5C2A5R0C0K1H03B	C0G	100	5pF	±0.25pF	3.6	3.5	6.0	5.0	2.5	0K1	500
	RCE5C2A6R0D0K1H03B	C0G	100	6pF	±0.5pF	3.6	3.5	6.0	5.0	2.5	0K1	500
	RCE5C2A7R0D0K1H03B	C0G	100	7pF	±0.5pF	3.6	3.5	6.0	5.0	2.5	0K1	500
	RCE5C2A8R0D0K1H03B	C0G	100	8pF	±0.5pF	3.6	3.5	6.0	5.0	2.5	0K1	500
	RCE5C2A9R0D0K1H03B	C0G	100	9pF	±0.5pF	3.6	3.5	6.0	5.0	2.5	0K1	500
	RCE5C2A100J0K1H03B	C0G	100	10pF	±5%	3.6	3.5	6.0	5.0	2.5	0K1	500
	RCE5C2A120J0K1H03B	C0G	100	12pF	±5%	3.6	3.5	6.0	5.0	2.5	0K1	500
	RCE5C2A150J0K1H03B	C0G	100	15pF	±5%	3.6	3.5	6.0	5.0	2.5	0K1	500
	RCE5C2A180J0K1H03B	C0G	100	18pF	±5%	3.6	3.5	6.0	5.0	2.5	0K1	500
	RCE5C2A220J0K1H03B	C0G	100	22pF	±5%	3.6	3.5	6.0	5.0	2.5	0K1	500
	RCE5C2A270J0K1H03B	C0G	100	27pF	±5%	3.6	3.5	6.0	5.0	2.5	0K1	500
	RCE5C2A330J0K1H03B	C0G	100	33pF	±5%	3.6	3.5	6.0	5.0	2.5	0K1	500
	RCE5C2A390J0K1H03B	C0G	100	39pF	±5%	3.6	3.5	6.0	5.0	2.5	0K1	500
	RCE5C2A470J0K1H03B	C0G	100	47pF	±5%	3.6	3.5	6.0	5.0	2.5	0K1	500
	RCE5C2A560J0K1H03B	C0G	100	56pF	±5%	3.6	3.5	6.0	5.0	2.5	0K1	500
	RCE5C2A680J0K1H03B	C0G	100	68pF	±5%	3.6	3.5	6.0	5.0	2.5	0K1	500
	RCE5C2A820J0K1H03B	C0G	100	82pF	±5%	3.6	3.5	6.0	5.0	2.5	0K1	500
	RCE5C2A101J0K1H03B	C0G	100	100pF	±5%	3.6	3.5	6.0	5.0	2.5	0K1	500
	RCE5C2A121J0K1H03B	C0G	100	120pF	±5%	3.6	3.5	6.0	5.0	2.5	0K1	500
	RCE5C2A151J0K1H03B	C0G	100	150pF	±5%	3.6	3.5	6.0	5.0	2.5	0K1	500
	RCE5C2A181J0K1H03B	C0G	100	180pF	±5%	3.6	3.5	6.0	5.0	2.5	0K1	500
	RCE5C2A221J0K1H03B	C0G	100	220pF	±5%	3.6	3.5	6.0	5.0	2.5	0K1	500
	RCE5C2A271J0K1H03B	C0G	100	270pF	±5%	3.6	3.5	6.0	5.0	2.5	0K1	500
	RCE5C2A331J0K1H03B	C0G	100	330pF	±5%	3.6	3.5	6.0	5.0	2.5	0K1	500
	RCE5C2A391J0K1H03B	C0G	100	390pF	±5%	3.6	3.5	6.0	5.0	2.5	0K1	500
	RCE5C2A471J0K1H03B	C0G	100	470pF	±5%	3.6	3.5	6.0	5.0	2.5	0K1	500
	RCE5C2A561J0K1H03B	C0G	100	560pF	±5%	3.6	3.5	6.0	5.0	2.5	0K1	500
	RCE5C2A681J0K1H03B	C0G	100	680pF	±5%	3.6	3.5	6.0	5.0	2.5	0K1	500
	RCE5C2A821J0K1H03B	C0G	100	820pF	±5%	3.6	3.5	6.0	5.0	2.5	0K1	500
	RCE5C2A102J0K1H03B	C0G	100	1000pF	±5%	3.6	3.5	6.0	5.0	2.5	0K1	500
	RCE5C2A122J0K1H03B	C0G	100	1200pF	±5%	3.6	3.5	6.0	5.0	2.5	0K1	500
	RCE5C2A152J0K1H03B	C0G	100	1500pF	±5%	3.6	3.5	6.0	5.0	2.5	0K1	500
	RCE5C2A182J1K1H03B	C0G	100	1800pF	±5%	4.0	3.5	5.0	5.0	2.5	1K1	500
	RCE5C2A222J1K1H03B	C0G	100	2200pF	±5%	4.0	3.5	5.0	5.0	2.5	1K1	500

- Inside Crimp
(Lead Style:K*)

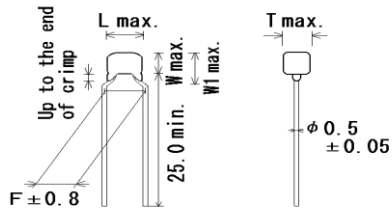

Unit : mm

Customer Part Number	Murata Part Number	T.C.	DC Rated Volt. (V)	Cap.	Cap. Tol.	Dimension (mm)					Dimension (LxW) Lead Style	Pack qty. (pcs)
						L	W	W1	F	T		
	RCE5C2A272J1K1H03B	C0G	100	2700pF	±5%	4.0	3.5	5.0	5.0	2.5	1K1	500
	RCE5C2A332J1K1H03B	C0G	100	3300pF	±5%	4.0	3.5	5.0	5.0	2.5	1K1	500
	RCE5C2A392J2K1H03B	C0G	100	3900pF	±5%	5.5	4.0	6.0	5.0	3.15	2K1	500
	RCE5C2A472J2K1H03B	C0G	100	4700pF	±5%	5.5	4.0	6.0	5.0	3.15	2K1	500
	RCE5C2A562J2K1H03B	C0G	100	5600pF	±5%	5.5	4.0	6.0	5.0	3.15	2K1	500
	RCE5C2A682J2K1H03B	C0G	100	6800pF	±5%	5.5	4.0	6.0	5.0	3.15	2K1	500
	RCE5C2A822J2K1H03B	C0G	100	8200pF	±5%	5.5	4.0	6.0	5.0	3.15	2K1	500
	RCE5C2A103J2K1H03B	C0G	100	10000pF	±5%	5.5	4.0	6.0	5.0	3.15	2K1	500

• Straight Taping
(Lead Style :DB)

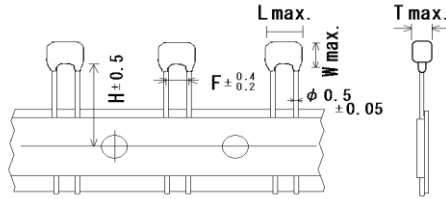

Unit : mm

Customer Part Number	Murata Part Number	T.C.	DC Rated Volt. (V)	Cap.	Cap. Tol.	Dimension (mm)						Dimension (LxW) Lead Style	Pack qty. (pcs)
						L	W	W1	F	T	H/H0		
	RCE5C1H1R0C0DBH03A	C0G	50	1pF	±0.25pF	3.6	3.5	-	2.5	2.5	16.0	0DB	2000
	RCE5C1H2R0C0DBH03A	C0G	50	2pF	±0.25pF	3.6	3.5	-	2.5	2.5	16.0	0DB	2000
	RCE5C1H3R0C0DBH03A	C0G	50	3pF	±0.25pF	3.6	3.5	-	2.5	2.5	16.0	0DB	2000
	RCE5C1H4R0C0DBH03A	C0G	50	4pF	±0.25pF	3.6	3.5	-	2.5	2.5	16.0	0DB	2000
	RCE5C1H5R0C0DBH03A	C0G	50	5pF	±0.25pF	3.6	3.5	-	2.5	2.5	16.0	0DB	2000
	RCE5C1H6R0D0DBH03A	C0G	50	6pF	±0.5pF	3.6	3.5	-	2.5	2.5	16.0	0DB	2000
	RCE5C1H7R0D0DBH03A	C0G	50	7pF	±0.5pF	3.6	3.5	-	2.5	2.5	16.0	0DB	2000
	RCE5C1H8R0D0DBH03A	C0G	50	8pF	±0.5pF	3.6	3.5	-	2.5	2.5	16.0	0DB	2000
	RCE5C1H9R0D0DBH03A	C0G	50	9pF	±0.5pF	3.6	3.5	-	2.5	2.5	16.0	0DB	2000
	RCE5C1H100J0DBH03A	C0G	50	10pF	±5%	3.6	3.5	-	2.5	2.5	16.0	0DB	2000
	RCE5C1H120J0DBH03A	C0G	50	12pF	±5%	3.6	3.5	-	2.5	2.5	16.0	0DB	2000
	RCE5C1H150J0DBH03A	C0G	50	15pF	±5%	3.6	3.5	-	2.5	2.5	16.0	0DB	2000
	RCE5C1H180J0DBH03A	C0G	50	18pF	±5%	3.6	3.5	-	2.5	2.5	16.0	0DB	2000
	RCE5C1H220J0DBH03A	C0G	50	22pF	±5%	3.6	3.5	-	2.5	2.5	16.0	0DB	2000
	RCE5C1H270J0DBH03A	C0G	50	27pF	±5%	3.6	3.5	-	2.5	2.5	16.0	0DB	2000
	RCE5C1H330J0DBH03A	C0G	50	33pF	±5%	3.6	3.5	-	2.5	2.5	16.0	0DB	2000
	RCE5C1H390J0DBH03A	C0G	50	39pF	±5%	3.6	3.5	-	2.5	2.5	16.0	0DB	2000
	RCE5C1H470J0DBH03A	C0G	50	47pF	±5%	3.6	3.5	-	2.5	2.5	16.0	0DB	2000
	RCE5C1H560J0DBH03A	C0G	50	56pF	±5%	3.6	3.5	-	2.5	2.5	16.0	0DB	2000
	RCE5C1H680J0DBH03A	C0G	50	68pF	±5%	3.6	3.5	-	2.5	2.5	16.0	0DB	2000
	RCE5C1H820J0DBH03A	C0G	50	82pF	±5%	3.6	3.5	-	2.5	2.5	16.0	0DB	2000
	RCE5C1H101J0DBH03A	C0G	50	100pF	±5%	3.6	3.5	-	2.5	2.5	16.0	0DB	2000
	RCE5C1H121J0DBH03A	C0G	50	120pF	±5%	3.6	3.5	-	2.5	2.5	16.0	0DB	2000
	RCE5C1H151J0DBH03A	C0G	50	150pF	±5%	3.6	3.5	-	2.5	2.5	16.0	0DB	2000
	RCE5C1H181J0DBH03A	C0G	50	180pF	±5%	3.6	3.5	-	2.5	2.5	16.0	0DB	2000
	RCE5C1H221J0DBH03A	C0G	50	220pF	±5%	3.6	3.5	-	2.5	2.5	16.0	0DB	2000
	RCE5C1H271J0DBH03A	C0G	50	270pF	±5%	3.6	3.5	-	2.5	2.5	16.0	0DB	2000
	RCE5C1H331J0DBH03A	C0G	50	330pF	±5%	3.6	3.5	-	2.5	2.5	16.0	0DB	2000
	RCE5C1H391J0DBH03A	C0G	50	390pF	±5%	3.6	3.5	-	2.5	2.5	16.0	0DB	2000
	RCE5C1H471J0DBH03A	C0G	50	470pF	±5%	3.6	3.5	-	2.5	2.5	16.0	0DB	2000
	RCE5C1H561J0DBH03A	C0G	50	560pF	±5%	3.6	3.5	-	2.5	2.5	16.0	0DB	2000
	RCE5C1H681J0DBH03A	C0G	50	680pF	±5%	3.6	3.5	-	2.5	2.5	16.0	0DB	2000
	RCE5C1H821J0DBH03A	C0G	50	820pF	±5%	3.6	3.5	-	2.5	2.5	16.0	0DB	2000
	RCE5C1H102J0DBH03A	C0G	50	1000pF	±5%	3.6	3.5	-	2.5	2.5	16.0	0DB	2000
	RCE5C1H122J0DBH03A	C0G	50	1200pF	±5%	3.6	3.5	-	2.5	2.5	16.0	0DB	2000
	RCE5C1H152J0DBH03A	C0G	50	1500pF	±5%	3.6	3.5	-	2.5	2.5	16.0	0DB	2000
	RCE5C1H182J0DBH03A	C0G	50	1800pF	±5%	3.6	3.5	-	2.5	2.5	16.0	0DB	2000
	RCE5C1H222J0DBH03A	C0G	50	2200pF	±5%	3.6	3.5	-	2.5	2.5	16.0	0DB	2000
	RCE5C1H272J0DBH03A	C0G	50	2700pF	±5%	3.6	3.5	-	2.5	2.5	16.0	0DB	2000
	RCE5C1H332J0DBH03A	C0G	50	3300pF	±5%	3.6	3.5	-	2.5	2.5	16.0	0DB	2000

• Straight Taping
(Lead Style :DB)

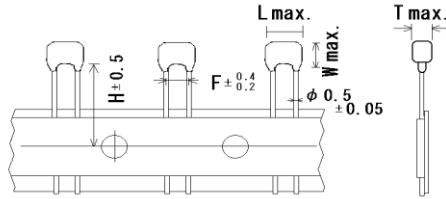

Unit : mm

Customer Part Number	Murata Part Number	T.C.	DC Rated Volt. (V)	Cap.	Cap. Tol.	Dimension (mm)						Dimension (LxW) Lead Style	Pack qty. (pcs)
						L	W	W1	F	T	H/H0		
	RCE5C1H392J0DBH03A	C0G	50	3900pF	±5%	3.6	3.5	-	2.5	2.5	16.0	0DB	2000
	RCE5C1H472J1DBH03A	C0G	50	4700pF	±5%	4.0	3.5	-	2.5	2.5	16.0	1DB	2000
	RCE5C1H562J1DBH03A	C0G	50	5600pF	±5%	4.0	3.5	-	2.5	2.5	16.0	1DB	2000
	RCE5C1H682J1DBH03A	C0G	50	6800pF	±5%	4.0	3.5	-	2.5	2.5	16.0	1DB	2000
	RCE5C1H822J1DBH03A	C0G	50	8200pF	±5%	4.0	3.5	-	2.5	2.5	16.0	1DB	2000
	RCE5C1H103J1DBH03A	C0G	50	10000pF	±5%	4.0	3.5	-	2.5	2.5	16.0	1DB	2000
	RCE5C1H123J1DBH03A	C0G	50	12000pF	±5%	4.0	3.5	-	2.5	2.5	16.0	1DB	2000
	RCE5C1H153J1DBH03A	C0G	50	15000pF	±5%	4.0	3.5	-	2.5	2.5	16.0	1DB	2000
	RCE5C1H183J1DBH03A	C0G	50	18000pF	±5%	4.0	3.5	-	2.5	2.5	16.0	1DB	2000
	RCE5C1H223J1DBH03A	C0G	50	22000pF	±5%	4.0	3.5	-	2.5	2.5	16.0	1DB	2000
	RCE5C1H273J2DBH03A	C0G	50	27000pF	±5%	5.5	4.0	-	2.5	3.15	16.0	2DB	2000
	RCE5C1H333J2DBH03A	C0G	50	33000pF	±5%	5.5	4.0	-	2.5	3.15	16.0	2DB	2000
	RCE5C1H393J2DBH03A	C0G	50	39000pF	±5%	5.5	4.0	-	2.5	3.15	16.0	2DB	2000
	RCE5C1H473J2DBH03A	C0G	50	47000pF	±5%	5.5	4.0	-	2.5	3.15	16.0	2DB	2000
	RCE5C1H563J2DBH03A	C0G	50	56000pF	±5%	5.5	4.0	-	2.5	3.15	16.0	2DB	2000
	RCE5C1H683J2DBH03A	C0G	50	68000pF	±5%	5.5	4.0	-	2.5	3.15	16.0	2DB	2000
	RCE5C1H823J2DBH03A	C0G	50	82000pF	±5%	5.5	4.0	-	2.5	3.15	16.0	2DB	2000
	RCE5C1H104J2DBH03A	C0G	50	0.1μF	±5%	5.5	4.0	-	2.5	3.15	16.0	2DB	2000
	RCE5C2A1R0C0DBH03A	C0G	100	1pF	±0.25pF	3.6	3.5	-	2.5	2.5	16.0	0DB	2000
	RCE5C2A2R0C0DBH03A	C0G	100	2pF	±0.25pF	3.6	3.5	-	2.5	2.5	16.0	0DB	2000
	RCE5C2A3R0C0DBH03A	C0G	100	3pF	±0.25pF	3.6	3.5	-	2.5	2.5	16.0	0DB	2000
	RCE5C2A4R0C0DBH03A	C0G	100	4pF	±0.25pF	3.6	3.5	-	2.5	2.5	16.0	0DB	2000
	RCE5C2A5R0C0DBH03A	C0G	100	5pF	±0.25pF	3.6	3.5	-	2.5	2.5	16.0	0DB	2000
	RCE5C2A6R0D0DBH03A	C0G	100	6pF	±0.5pF	3.6	3.5	-	2.5	2.5	16.0	0DB	2000
	RCE5C2A7R0D0DBH03A	C0G	100	7pF	±0.5pF	3.6	3.5	-	2.5	2.5	16.0	0DB	2000
	RCE5C2A8R0D0DBH03A	C0G	100	8pF	±0.5pF	3.6	3.5	-	2.5	2.5	16.0	0DB	2000
	RCE5C2A9R0D0DBH03A	C0G	100	9pF	±0.5pF	3.6	3.5	-	2.5	2.5	16.0	0DB	2000
	RCE5C2A100J0DBH03A	C0G	100	10pF	±5%	3.6	3.5	-	2.5	2.5	16.0	0DB	2000
	RCE5C2A120J0DBH03A	C0G	100	12pF	±5%	3.6	3.5	-	2.5	2.5	16.0	0DB	2000
	RCE5C2A150J0DBH03A	C0G	100	15pF	±5%	3.6	3.5	-	2.5	2.5	16.0	0DB	2000
	RCE5C2A180J0DBH03A	C0G	100	18pF	±5%	3.6	3.5	-	2.5	2.5	16.0	0DB	2000
	RCE5C2A220J0DBH03A	C0G	100	22pF	±5%	3.6	3.5	-	2.5	2.5	16.0	0DB	2000
	RCE5C2A270J0DBH03A	C0G	100	27pF	±5%	3.6	3.5	-	2.5	2.5	16.0	0DB	2000
	RCE5C2A330J0DBH03A	C0G	100	33pF	±5%	3.6	3.5	-	2.5	2.5	16.0	0DB	2000
	RCE5C2A390J0DBH03A	C0G	100	39pF	±5%	3.6	3.5	-	2.5	2.5	16.0	0DB	2000
	RCE5C2A470J0DBH03A	C0G	100	47pF	±5%	3.6	3.5	-	2.5	2.5	16.0	0DB	2000
	RCE5C2A560J0DBH03A	C0G	100	56pF	±5%	3.6	3.5	-	2.5	2.5	16.0	0DB	2000
	RCE5C2A680J0DBH03A	C0G	100	68pF	±5%	3.6	3.5	-	2.5	2.5	16.0	0DB	2000
	RCE5C2A820J0DBH03A	C0G	100	82pF	±5%	3.6	3.5	-	2.5	2.5	16.0	0DB	2000
	RCE5C2A101J0DBH03A	C0G	100	100pF	±5%	3.6	3.5	-	2.5	2.5	16.0	0DB	2000

• Straight Taping
(Lead Style:DB)

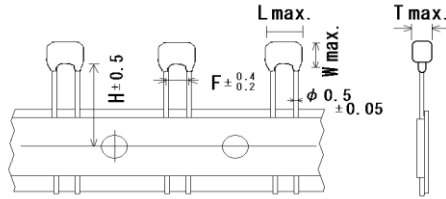

• Inside Crimp Taping
(Lead Style:M*)

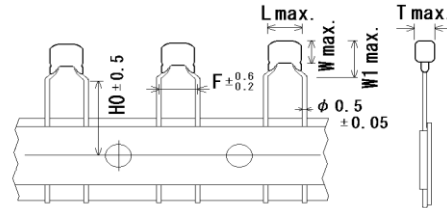

Unit : mm

Customer Part Number	Murata Part Number	T.C.	DC Rated Volt. (V)	Cap.	Cap. Tol.	Dimension (mm)						Dimension (LxW) Lead Style	Pack qty. (pcs)
						L	W	W1	F	T	H/H0		
	RCE5C2A121J0DBH03A	C0G	100	120pF	±5%	3.6	3.5	-	2.5	2.5	16.0	0DB	2000
	RCE5C2A151J0DBH03A	C0G	100	150pF	±5%	3.6	3.5	-	2.5	2.5	16.0	0DB	2000
	RCE5C2A181J0DBH03A	C0G	100	180pF	±5%	3.6	3.5	-	2.5	2.5	16.0	0DB	2000
	RCE5C2A221J0DBH03A	C0G	100	220pF	±5%	3.6	3.5	-	2.5	2.5	16.0	0DB	2000
	RCE5C2A271J0DBH03A	C0G	100	270pF	±5%	3.6	3.5	-	2.5	2.5	16.0	0DB	2000
	RCE5C2A331J0DBH03A	C0G	100	330pF	±5%	3.6	3.5	-	2.5	2.5	16.0	0DB	2000
	RCE5C2A391J0DBH03A	C0G	100	390pF	±5%	3.6	3.5	-	2.5	2.5	16.0	0DB	2000
	RCE5C2A471J0DBH03A	C0G	100	470pF	±5%	3.6	3.5	-	2.5	2.5	16.0	0DB	2000
	RCE5C2A561J0DBH03A	C0G	100	560pF	±5%	3.6	3.5	-	2.5	2.5	16.0	0DB	2000
	RCE5C2A681J0DBH03A	C0G	100	680pF	±5%	3.6	3.5	-	2.5	2.5	16.0	0DB	2000
	RCE5C2A821J0DBH03A	C0G	100	820pF	±5%	3.6	3.5	-	2.5	2.5	16.0	0DB	2000
	RCE5C2A102J0DBH03A	C0G	100	1000pF	±5%	3.6	3.5	-	2.5	2.5	16.0	0DB	2000
	RCE5C2A122J0DBH03A	C0G	100	1200pF	±5%	3.6	3.5	-	2.5	2.5	16.0	0DB	2000
	RCE5C2A152J0DBH03A	C0G	100	1500pF	±5%	3.6	3.5	-	2.5	2.5	16.0	0DB	2000
	RCE5C2A182J1DBH03A	C0G	100	1800pF	±5%	4.0	3.5	-	2.5	2.5	16.0	1DB	2000
	RCE5C2A222J1DBH03A	C0G	100	2200pF	±5%	4.0	3.5	-	2.5	2.5	16.0	1DB	2000
	RCE5C2A272J1DBH03A	C0G	100	2700pF	±5%	4.0	3.5	-	2.5	2.5	16.0	1DB	2000
	RCE5C2A332J1DBH03A	C0G	100	3300pF	±5%	4.0	3.5	-	2.5	2.5	16.0	1DB	2000
	RCE5C2A392J2DBH03A	C0G	100	3900pF	±5%	5.5	4.0	-	2.5	3.15	16.0	2DB	2000
	RCE5C2A472J2DBH03A	C0G	100	4700pF	±5%	5.5	4.0	-	2.5	3.15	16.0	2DB	2000
	RCE5C2A562J2DBH03A	C0G	100	5600pF	±5%	5.5	4.0	-	2.5	3.15	16.0	2DB	2000
	RCE5C2A682J2DBH03A	C0G	100	6800pF	±5%	5.5	4.0	-	2.5	3.15	16.0	2DB	2000
	RCE5C2A822J2DBH03A	C0G	100	8200pF	±5%	5.5	4.0	-	2.5	3.15	16.0	2DB	2000
	RCE5C2A103J2DBH03A	C0G	100	10000pF	±5%	5.5	4.0	-	2.5	3.15	16.0	2DB	2000
	RCE5C1H1ROC0M1H03A	C0G	50	1pF	±0.25pF	3.6	3.5	6.0	5.0	2.5	16.0	0M1	2000
	RCE5C1H2ROC0M1H03A	C0G	50	2pF	±0.25pF	3.6	3.5	6.0	5.0	2.5	16.0	0M1	2000
	RCE5C1H3ROC0M1H03A	C0G	50	3pF	±0.25pF	3.6	3.5	6.0	5.0	2.5	16.0	0M1	2000
	RCE5C1H4ROC0M1H03A	C0G	50	4pF	±0.25pF	3.6	3.5	6.0	5.0	2.5	16.0	0M1	2000
	RCE5C1H5ROC0M1H03A	C0G	50	5pF	±0.25pF	3.6	3.5	6.0	5.0	2.5	16.0	0M1	2000
	RCE5C1H6R0D0M1H03A	C0G	50	6pF	±0.5pF	3.6	3.5	6.0	5.0	2.5	16.0	0M1	2000
	RCE5C1H7R0D0M1H03A	C0G	50	7pF	±0.5pF	3.6	3.5	6.0	5.0	2.5	16.0	0M1	2000
	RCE5C1H8R0D0M1H03A	C0G	50	8pF	±0.5pF	3.6	3.5	6.0	5.0	2.5	16.0	0M1	2000
	RCE5C1H9R0D0M1H03A	C0G	50	9pF	±0.5pF	3.6	3.5	6.0	5.0	2.5	16.0	0M1	2000
	RCE5C1H100J0M1H03A	C0G	50	10pF	±5%	3.6	3.5	6.0	5.0	2.5	16.0	0M1	2000
	RCE5C1H120J0M1H03A	C0G	50	12pF	±5%	3.6	3.5	6.0	5.0	2.5	16.0	0M1	2000
	RCE5C1H150J0M1H03A	C0G	50	15pF	±5%	3.6	3.5	6.0	5.0	2.5	16.0	0M1	2000
	RCE5C1H180J0M1H03A	C0G	50	18pF	±5%	3.6	3.5	6.0	5.0	2.5	16.0	0M1	2000
	RCE5C1H220J0M1H03A	C0G	50	22pF	±5%	3.6	3.5	6.0	5.0	2.5	16.0	0M1	2000
	RCE5C1H270J0M1H03A	C0G	50	27pF	±5%	3.6	3.5	6.0	5.0	2.5	16.0	0M1	2000
	RCE5C1H330J0M1H03A	C0G	50	33pF	±5%	3.6	3.5	6.0	5.0	2.5	16.0	0M1	2000

• Inside Crimp Taping
(Lead Style: M*)

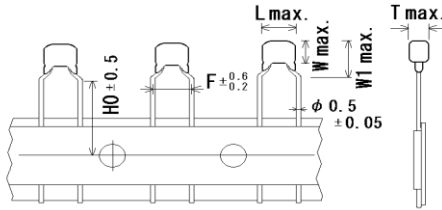

Unit : mm

Customer Part Number	Murata Part Number	T.C.	DC Rated Volt. (V)	Cap.	Cap. Tol.	Dimension (mm)						Dimension (LxW) Lead Style	Pack qty. (pcs)
						L	W	W1	F	T	H/H0		
	RCE5C1H390J0M1H03A	C0G	50	39pF	±5%	3.6	3.5	6.0	5.0	2.5	16.0	0M1	2000
	RCE5C1H470J0M1H03A	C0G	50	47pF	±5%	3.6	3.5	6.0	5.0	2.5	16.0	0M1	2000
	RCE5C1H560J0M1H03A	C0G	50	56pF	±5%	3.6	3.5	6.0	5.0	2.5	16.0	0M1	2000
	RCE5C1H680J0M1H03A	C0G	50	68pF	±5%	3.6	3.5	6.0	5.0	2.5	16.0	0M1	2000
	RCE5C1H820J0M1H03A	C0G	50	82pF	±5%	3.6	3.5	6.0	5.0	2.5	16.0	0M1	2000
	RCE5C1H101J0M1H03A	C0G	50	100pF	±5%	3.6	3.5	6.0	5.0	2.5	16.0	0M1	2000
	RCE5C1H121J0M1H03A	C0G	50	120pF	±5%	3.6	3.5	6.0	5.0	2.5	16.0	0M1	2000
	RCE5C1H151J0M1H03A	C0G	50	150pF	±5%	3.6	3.5	6.0	5.0	2.5	16.0	0M1	2000
	RCE5C1H181J0M1H03A	C0G	50	180pF	±5%	3.6	3.5	6.0	5.0	2.5	16.0	0M1	2000
	RCE5C1H221J0M1H03A	C0G	50	220pF	±5%	3.6	3.5	6.0	5.0	2.5	16.0	0M1	2000
	RCE5C1H271J0M1H03A	C0G	50	270pF	±5%	3.6	3.5	6.0	5.0	2.5	16.0	0M1	2000
	RCE5C1H331J0M1H03A	C0G	50	330pF	±5%	3.6	3.5	6.0	5.0	2.5	16.0	0M1	2000
	RCE5C1H391J0M1H03A	C0G	50	390pF	±5%	3.6	3.5	6.0	5.0	2.5	16.0	0M1	2000
	RCE5C1H471J0M1H03A	C0G	50	470pF	±5%	3.6	3.5	6.0	5.0	2.5	16.0	0M1	2000
	RCE5C1H561J0M1H03A	C0G	50	560pF	±5%	3.6	3.5	6.0	5.0	2.5	16.0	0M1	2000
	RCE5C1H681J0M1H03A	C0G	50	680pF	±5%	3.6	3.5	6.0	5.0	2.5	16.0	0M1	2000
	RCE5C1H821J0M1H03A	C0G	50	820pF	±5%	3.6	3.5	6.0	5.0	2.5	16.0	0M1	2000
	RCE5C1H102J0M1H03A	C0G	50	1000pF	±5%	3.6	3.5	6.0	5.0	2.5	16.0	0M1	2000
	RCE5C1H122J0M1H03A	C0G	50	1200pF	±5%	3.6	3.5	6.0	5.0	2.5	16.0	0M1	2000
	RCE5C1H152J0M1H03A	C0G	50	1500pF	±5%	3.6	3.5	6.0	5.0	2.5	16.0	0M1	2000
	RCE5C1H182J0M1H03A	C0G	50	1800pF	±5%	3.6	3.5	6.0	5.0	2.5	16.0	0M1	2000
	RCE5C1H222J0M1H03A	C0G	50	2200pF	±5%	3.6	3.5	6.0	5.0	2.5	16.0	0M1	2000
	RCE5C1H272J0M1H03A	C0G	50	2700pF	±5%	3.6	3.5	6.0	5.0	2.5	16.0	0M1	2000
	RCE5C1H332J0M1H03A	C0G	50	3300pF	±5%	3.6	3.5	6.0	5.0	2.5	16.0	0M1	2000
	RCE5C1H392J0M1H03A	C0G	50	3900pF	±5%	3.6	3.5	6.0	5.0	2.5	16.0	0M1	2000
	RCE5C1H472J1M1H03A	C0G	50	4700pF	±5%	4.0	3.5	5.0	5.0	2.5	16.0	1M1	2000
	RCE5C1H562J1M1H03A	C0G	50	5600pF	±5%	4.0	3.5	5.0	5.0	2.5	16.0	1M1	2000
	RCE5C1H682J1M1H03A	C0G	50	6800pF	±5%	4.0	3.5	5.0	5.0	2.5	16.0	1M1	2000
	RCE5C1H822J1M1H03A	C0G	50	8200pF	±5%	4.0	3.5	5.0	5.0	2.5	16.0	1M1	2000
	RCE5C1H103J1M1H03A	C0G	50	10000pF	±5%	4.0	3.5	5.0	5.0	2.5	16.0	1M1	2000
	RCE5C1H123J1M1H03A	C0G	50	12000pF	±5%	4.0	3.5	5.0	5.0	2.5	16.0	1M1	2000
	RCE5C1H153J1M1H03A	C0G	50	15000pF	±5%	4.0	3.5	5.0	5.0	2.5	16.0	1M1	2000
	RCE5C1H183J1M1H03A	C0G	50	18000pF	±5%	4.0	3.5	5.0	5.0	2.5	16.0	1M1	2000
	RCE5C1H223J1M1H03A	C0G	50	22000pF	±5%	4.0	3.5	5.0	5.0	2.5	16.0	1M1	2000
	RCE5C1H273J2M1H03A	C0G	50	27000pF	±5%	5.5	4.0	6.0	5.0	3.15	16.0	2M1	2000
	RCE5C1H333J2M1H03A	C0G	50	33000pF	±5%	5.5	4.0	6.0	5.0	3.15	16.0	2M1	2000
	RCE5C1H393J2M1H03A	C0G	50	39000pF	±5%	5.5	4.0	6.0	5.0	3.15	16.0	2M1	2000
	RCE5C1H473J2M1H03A	C0G	50	47000pF	±5%	5.5	4.0	6.0	5.0	3.15	16.0	2M1	2000
	RCE5C1H563J2M1H03A	C0G	50	56000pF	±5%	5.5	4.0	6.0	5.0	3.15	16.0	2M1	2000
	RCE5C1H683J2M1H03A	C0G	50	68000pF	±5%	5.5	4.0	6.0	5.0	3.15	16.0	2M1	2000

• Inside Crimp Taping
(Lead Style: M*)

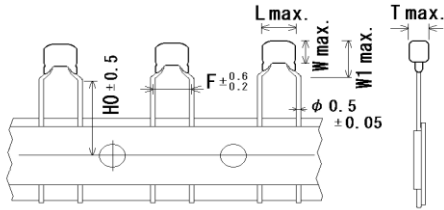

Unit : mm

Customer Part Number	Murata Part Number	T.C.	DC Rated Volt. (V)	Cap.	Cap. Tol.	Dimension (mm)						Dimension (LxW) Lead Style	Pack qty. (pcs)
						L	W	W1	F	T	H/H0		
	RCE5C1H823J2M1H03A	C0G	50	82000pF	±5%	5.5	4.0	6.0	5.0	3.15	16.0	2M1	2000
	RCE5C1H104J2M1H03A	C0G	50	0.1µF	±5%	5.5	4.0	6.0	5.0	3.15	16.0	2M1	2000
	RCE5C2A1R0C0M1H03A	C0G	100	1pF	±0.25pF	3.6	3.5	6.0	5.0	2.5	16.0	0M1	2000
	RCE5C2A2R0C0M1H03A	C0G	100	2pF	±0.25pF	3.6	3.5	6.0	5.0	2.5	16.0	0M1	2000
	RCE5C2A3R0C0M1H03A	C0G	100	3pF	±0.25pF	3.6	3.5	6.0	5.0	2.5	16.0	0M1	2000
	RCE5C2A4R0C0M1H03A	C0G	100	4pF	±0.25pF	3.6	3.5	6.0	5.0	2.5	16.0	0M1	2000
	RCE5C2A5R0C0M1H03A	C0G	100	5pF	±0.25pF	3.6	3.5	6.0	5.0	2.5	16.0	0M1	2000
	RCE5C2A6R0D0M1H03A	C0G	100	6pF	±0.5pF	3.6	3.5	6.0	5.0	2.5	16.0	0M1	2000
	RCE5C2A7R0D0M1H03A	C0G	100	7pF	±0.5pF	3.6	3.5	6.0	5.0	2.5	16.0	0M1	2000
	RCE5C2A8R0D0M1H03A	C0G	100	8pF	±0.5pF	3.6	3.5	6.0	5.0	2.5	16.0	0M1	2000
	RCE5C2A9R0D0M1H03A	C0G	100	9pF	±0.5pF	3.6	3.5	6.0	5.0	2.5	16.0	0M1	2000
	RCE5C2A100J0M1H03A	C0G	100	10pF	±5%	3.6	3.5	6.0	5.0	2.5	16.0	0M1	2000
	RCE5C2A120J0M1H03A	C0G	100	12pF	±5%	3.6	3.5	6.0	5.0	2.5	16.0	0M1	2000
	RCE5C2A150J0M1H03A	C0G	100	15pF	±5%	3.6	3.5	6.0	5.0	2.5	16.0	0M1	2000
	RCE5C2A180J0M1H03A	C0G	100	18pF	±5%	3.6	3.5	6.0	5.0	2.5	16.0	0M1	2000
	RCE5C2A220J0M1H03A	C0G	100	22pF	±5%	3.6	3.5	6.0	5.0	2.5	16.0	0M1	2000
	RCE5C2A270J0M1H03A	C0G	100	27pF	±5%	3.6	3.5	6.0	5.0	2.5	16.0	0M1	2000
	RCE5C2A330J0M1H03A	C0G	100	33pF	±5%	3.6	3.5	6.0	5.0	2.5	16.0	0M1	2000
	RCE5C2A390J0M1H03A	C0G	100	39pF	±5%	3.6	3.5	6.0	5.0	2.5	16.0	0M1	2000
	RCE5C2A470J0M1H03A	C0G	100	47pF	±5%	3.6	3.5	6.0	5.0	2.5	16.0	0M1	2000
	RCE5C2A560J0M1H03A	C0G	100	56pF	±5%	3.6	3.5	6.0	5.0	2.5	16.0	0M1	2000
	RCE5C2A680J0M1H03A	C0G	100	68pF	±5%	3.6	3.5	6.0	5.0	2.5	16.0	0M1	2000
	RCE5C2A820J0M1H03A	C0G	100	82pF	±5%	3.6	3.5	6.0	5.0	2.5	16.0	0M1	2000
	RCE5C2A101J0M1H03A	C0G	100	100pF	±5%	3.6	3.5	6.0	5.0	2.5	16.0	0M1	2000
	RCE5C2A121J0M1H03A	C0G	100	120pF	±5%	3.6	3.5	6.0	5.0	2.5	16.0	0M1	2000
	RCE5C2A151J0M1H03A	C0G	100	150pF	±5%	3.6	3.5	6.0	5.0	2.5	16.0	0M1	2000
	RCE5C2A181J0M1H03A	C0G	100	180pF	±5%	3.6	3.5	6.0	5.0	2.5	16.0	0M1	2000
	RCE5C2A221J0M1H03A	C0G	100	220pF	±5%	3.6	3.5	6.0	5.0	2.5	16.0	0M1	2000
	RCE5C2A271J0M1H03A	C0G	100	270pF	±5%	3.6	3.5	6.0	5.0	2.5	16.0	0M1	2000
	RCE5C2A331J0M1H03A	C0G	100	330pF	±5%	3.6	3.5	6.0	5.0	2.5	16.0	0M1	2000
	RCE5C2A391J0M1H03A	C0G	100	390pF	±5%	3.6	3.5	6.0	5.0	2.5	16.0	0M1	2000
	RCE5C2A471J0M1H03A	C0G	100	470pF	±5%	3.6	3.5	6.0	5.0	2.5	16.0	0M1	2000
	RCE5C2A561J0M1H03A	C0G	100	560pF	±5%	3.6	3.5	6.0	5.0	2.5	16.0	0M1	2000
	RCE5C2A681J0M1H03A	C0G	100	680pF	±5%	3.6	3.5	6.0	5.0	2.5	16.0	0M1	2000
	RCE5C2A821J0M1H03A	C0G	100	820pF	±5%	3.6	3.5	6.0	5.0	2.5	16.0	0M1	2000
	RCE5C2A102J0M1H03A	C0G	100	1000pF	±5%	3.6	3.5	6.0	5.0	2.5	16.0	0M1	2000
	RCE5C2A122J0M1H03A	C0G	100	1200pF	±5%	3.6	3.5	6.0	5.0	2.5	16.0	0M1	2000
	RCE5C2A152J0M1H03A	C0G	100	1500pF	±5%	3.6	3.5	6.0	5.0	2.5	16.0	0M1	2000
	RCE5C2A182J1M1H03A	C0G	100	1800pF	±5%	4.0	3.5	5.0	5.0	2.5	16.0	1M1	2000
	RCE5C2A222J1M1H03A	C0G	100	2200pF	±5%	4.0	3.5	5.0	5.0	2.5	16.0	1M1	2000

• Inside Crimp Taping
(Lead Style: M*)

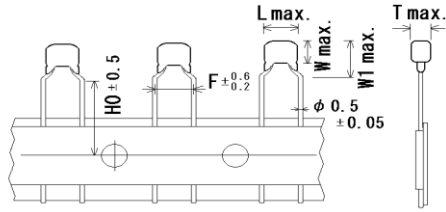

Unit : mm

Customer Part Number	Murata Part Number	T.C.	DC Rated Volt. (V)	Cap.	Cap. Tol.	Dimension (mm)						Dimension (LxW) Lead Style	Pack qty. (pcs)
						L	W	W1	F	T	H/H0		
	RCE5C2A272J1M1H03A	C0G	100	2700pF	±5%	4.0	3.5	5.0	5.0	2.5	16.0	1M1	2000
	RCE5C2A332J1M1H03A	C0G	100	3300pF	±5%	4.0	3.5	5.0	5.0	2.5	16.0	1M1	2000
	RCE5C2A392J2M1H03A	C0G	100	3900pF	±5%	5.5	4.0	6.0	5.0	3.15	16.0	2M1	2000
	RCE5C2A472J2M1H03A	C0G	100	4700pF	±5%	5.5	4.0	6.0	5.0	3.15	16.0	2M1	2000
	RCE5C2A562J2M1H03A	C0G	100	5600pF	±5%	5.5	4.0	6.0	5.0	3.15	16.0	2M1	2000
	RCE5C2A682J2M1H03A	C0G	100	6800pF	±5%	5.5	4.0	6.0	5.0	3.15	16.0	2M1	2000
	RCE5C2A822J2M1H03A	C0G	100	8200pF	±5%	5.5	4.0	6.0	5.0	3.15	16.0	2M1	2000
	RCE5C2A103J2M1H03A	C0G	100	10000pF	±5%	5.5	4.0	6.0	5.0	3.15	16.0	2M1	2000

Reference only

5. Specification				
No.	Test Item	Specification	Test Method (Compliant Standard:AEC-Q200)	
1	Pre-and Post-Stress Electrical Test		-	
2	High Temperature Exposure (Storage)	Appearance	No defects or abnormalities	
		Capacitance Change	Within $\pm 3\%$ or $\pm 0.3\text{pF}$ (Whichever is larger)	
		Q	$30\text{pF} \leq C : Q \geq 350$ $10\text{pF} \leq C < 30\text{pF} : Q \geq 275+5C/2$ $10\text{pF} > C : Q \geq 200+10C$ C : Nominal Capacitance (pF)	
		I.R.	More than $1,000\text{M}\Omega$ or $50\text{M}\Omega \cdot \mu\text{F}$ (Whichever is smaller)	
3	Temperature Cycling	Appearance	No defects or abnormalities	
		Capacitance Change	Within $\pm 5\%$ or $\pm 0.5\text{pF}$ (Whichever is larger)	
		Q	$30\text{pF} \leq C : Q \geq 350$ $10\text{pF} \leq C < 30\text{pF} : Q \geq 275+5C/2$ $10\text{pF} > C : Q \geq 200+10C$ C : Nominal Capacitance (pF)	
		I.R.	$1,000\text{M}\Omega$ or $50\text{M}\Omega \cdot \mu\text{F}$ min. (Whichever is smaller)	
4	Moisture Resistance	Appearance	No defects or abnormalities	
		Capacitance Change	Within $\pm 5\%$ or $\pm 0.5\text{pF}$ (Whichever is larger)	
		Q	$30\text{pF} \leq C : Q \geq 200$ $30\text{pF} > C : Q \geq 100+10C/3$ C : Nominal Capacitance (pF)	
		I.R.	$500\text{M}\Omega$ or $25\text{M}\Omega \cdot \mu\text{F}$ min. (Whichever is smaller)	
5	Biased Humidity	Appearance	No defects or abnormalities	
		Capacitance Change	Within $\pm 5\%$ or $\pm 0.5\text{pF}$ (Whichever is larger)	
		Q	$30\text{pF} \leq C : Q \geq 200$ $30\text{pF} > C : Q \geq 100+10C/3$ C : Nominal Capacitance (pF)	
		I.R.	$500\text{M}\Omega$ or $25\text{M}\Omega \cdot \mu\text{F}$ min. (Whichever is smaller)	
6	Operational Life	Appearance	No defects or abnormalities	
		Capacitance Change	Within $\pm 3\%$ or $\pm 0.3\text{pF}$ (Whichever is larger)	
		Q	$30\text{pF} \leq C : Q \geq 350$ $10\text{pF} \leq C < 30\text{pF} : Q \geq 275+5C/2$ $10\text{pF} > C : Q \geq 200+10C$ C : Nominal Capacitance (pF)	
		I.R.	$1,000\text{M}\Omega$ or $50\text{M}\Omega \cdot \mu\text{F}$ min. (Whichever is smaller)	
* "room condition" Temperature : 15 to 35°C, Relative humidity : 45 to 75%, Atmosphere pressure : 86 to 106kPa				

Sit the capacitor for $1000 \pm 12\text{h}$ at $150 \pm 3^\circ\text{C}$. Let sit for $24 \pm 2\text{h}$ at *room condition, then measure.

Perform the 1000 cycles according to the four heat treatments listed in the following table. Let sit for $24 \pm 2\text{h}$ at *room condition, then measure.

Step	1	2	3	4
Temp. (°C)	$-55 \pm 0/-3$	Room Temp.	$125 \pm 3/-0$	Room Temp.
Time (min.)	15 ± 3	1	15 ± 3	1

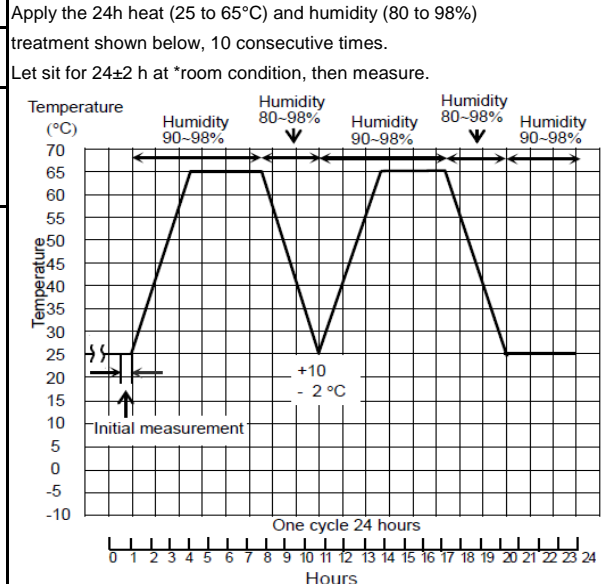

Apply the rated voltage and DC $1.3 \pm 0.2/-0\text{V}$ (add $100\text{k}\Omega$ resistor) at $85 \pm 3^\circ\text{C}$ and 80 to 85% humidity for $1,000 \pm 12\text{h}$. Remove and let sit for $24 \pm 2\text{h}$ at *room condition, then measure. The charge/discharge current is less than 50mA .

Apply 200% of the rated voltage for $1000 \pm 12\text{h}$ at $125 \pm 3^\circ\text{C}$. Let sit for $24 \pm 2\text{h}$ at *room condition, then measure. The charge/discharge current is less than 50mA .

Reference only

No.	Test Item	Specification	Test Method (Compliant Standard:AEC-Q200)									
7	External Visual	No defects or abnormalities.	Visual inspection.									
8	Physical Dimension	Within the specified dimensions.	Using calipers and micrometers.									
9	Marking	To be easily legible.	Visual inspection.									
10	Resistance to Solvents	Appearance	Per MIL-STD-202 Method 215. Solvent 1 : 1 part (by volume) of isopropyl alcohol 3 parts (by volume) of mineral spirits Solvent 2 : Terpene defluxer Solvent 3 : 42 parts (by volume) of water 1part (by volume) of propylene glycol monomethyl ether 1 part (by volume) of monoethanolamine									
		Capacitance										
		Q										
		I.R.										
11	Mechanical Shock	Appearance	Three shocks in each direction should be applied along 3 mutually perpendicular axes of the test specimen (18 shocks). The specified test pulse should be Half-sine and should have a duration : 0.5ms, peak value : 1500G and velocity change : 4.7m/s.									
		Capacitance										
		Q										
12	Vibration	Appearance	The capacitor should be subjected to a simple harmonic motion having a total amplitude of 1.5mm, the frequency being varied uniformly between the approximate limits of 10 and 2,000Hz. The frequency range, from 10 to 2000Hz and return to 10Hz, should be traversed in approximately 20 min. This motion should be applied for 12 items in each 3 mutually perpendicular directions (total of 36 times).									
		Capacitance										
		Q										
13-1	Resistance to Soldering Heat (Non-Preheat)	Appearance	The lead wires should be immersed in the melted solder 1.5 to 2.0mm from the root of terminal at 260±5°C for 10±1 seconds. • Post-treatment Capacitor should be stored for 24±2 hours at *room condition.									
		Capacitance										
		Change										
		Dielectric Strength (Between terminals)										
13-2	Resistance to Soldering Heat (On-Preheat)	Appearance	First the capacitor should be stored at 120+0/-5°C for 60+0/-5 seconds. Then, the lead wires should be immersed in the melted solder 1.5 to 2.0mm from the root of terminal at 260±5°C for 7.5+0/-1 seconds. • Post-treatment Capacitor should be stored for 24±2 hours at *room condition.									
		Capacitance										
		Change										
		Dielectric Strength (Between terminals)										
13-3	Resistance to Soldering Heat (soldering iron method)	Appearance	Test condition Temperature of iron-tip : 350±10°C Soldering time : 3.5±0.5 seconds Soldering position Straight Lead : 1.5 to 2.0mm from the root of terminal. Crimp Lead : 1.5 to 2.0mm from the end of lead bend. • Post-treatment Capacitor should be stored for 24±2 hours at *room condition.									
		Capacitance										
		Change										
		Dielectric Strength (Between terminals)										
14	Thermal Shock	Appearance	Perform the 300 cycles according to the two heat treatments listed in the following table (Maximum transfer time is 20s.). Let sit for 24±2 h at *room condition, then measure.									
		Capacitance										
		Change										
		Q										
		<table border="1"> <thead> <tr> <th>Step</th> <th>1</th> <th>2</th> </tr> </thead> <tbody> <tr> <td>Temp. (°C)</td> <td>-55+0/-3</td> <td>125+3/-0</td> </tr> <tr> <td>Time (min.)</td> <td>15±3</td> <td>15±3</td> </tr> </tbody> </table>		Step	1	2	Temp. (°C)	-55+0/-3	125+3/-0	Time (min.)	15±3	15±3
Step	1	2										
Temp. (°C)	-55+0/-3	125+3/-0										
Time (min.)	15±3	15±3										
		<table border="1"> <thead> <tr> <th>Step</th> <th>1</th> <th>2</th> </tr> </thead> <tbody> <tr> <td>Temp. (°C)</td> <td>-55+0/-3</td> <td>125+3/-0</td> </tr> <tr> <td>Time (min.)</td> <td>15±3</td> <td>15±3</td> </tr> </tbody> </table>		Step	1	2	Temp. (°C)	-55+0/-3	125+3/-0	Time (min.)	15±3	15±3
Step	1	2										
Temp. (°C)	-55+0/-3	125+3/-0										
Time (min.)	15±3	15±3										
		<table border="1"> <thead> <tr> <th>Step</th> <th>1</th> <th>2</th> </tr> </thead> <tbody> <tr> <td>Temp. (°C)</td> <td>-55+0/-3</td> <td>125+3/-0</td> </tr> <tr> <td>Time (min.)</td> <td>15±3</td> <td>15±3</td> </tr> </tbody> </table>		Step	1	2	Temp. (°C)	-55+0/-3	125+3/-0	Time (min.)	15±3	15±3
Step	1	2										
Temp. (°C)	-55+0/-3	125+3/-0										
Time (min.)	15±3	15±3										
		<table border="1"> <thead> <tr> <th>Step</th> <th>1</th> <th>2</th> </tr> </thead> <tbody> <tr> <td>Temp. (°C)</td> <td>-55+0/-3</td> <td>125+3/-0</td> </tr> <tr> <td>Time (min.)</td> <td>15±3</td> <td>15±3</td> </tr> </tbody> </table>		Step	1	2	Temp. (°C)	-55+0/-3	125+3/-0	Time (min.)	15±3	15±3
Step	1	2										
Temp. (°C)	-55+0/-3	125+3/-0										
Time (min.)	15±3	15±3										
		<table border="1"> <thead> <tr> <th>Step</th> <th>1</th> <th>2</th> </tr> </thead> <tbody> <tr> <td>Temp. (°C)</td> <td>-55+0/-3</td> <td>125+3/-0</td> </tr> <tr> <td>Time (min.)</td> <td>15±3</td> <td>15±3</td> </tr> </tbody> </table>		Step	1	2	Temp. (°C)	-55+0/-3	125+3/-0	Time (min.)	15±3	15±3
Step	1	2										
Temp. (°C)	-55+0/-3	125+3/-0										
Time (min.)	15±3	15±3										
		<table border="1"> <thead> <tr> <th>Step</th> <th>1</th> <th>2</th> </tr> </thead> <tbody> <tr> <td>Temp. (°C)</td> <td>-55+0/-3</td> <td>125+3/-0</td> </tr> <tr> <td>Time (min.)</td> <td>15±3</td> <td>15±3</td> </tr> </tbody> </table>		Step	1	2	Temp. (°C)	-55+0/-3	125+3/-0	Time (min.)	15±3	15±3
Step	1	2										
Temp. (°C)	-55+0/-3	125+3/-0										
Time (min.)	15±3	15±3										
		<table border="1"> <thead> <tr> <th>Step</th> <th>1</th> <th>2</th> </tr> </thead> <tbody> <tr> <td>Temp. (°C)</td> <td>-55+0/-3</td> <td>125+3/-0</td> </tr> <tr> <td>Time (min.)</td> <td>15±3</td> <td>15±3</td> </tr> </tbody> </table>		Step	1	2	Temp. (°C)	-55+0/-3	125+3/-0	Time (min.)	15±3	15±3
Step	1	2										
Temp. (°C)	-55+0/-3	125+3/-0										
Time (min.)	15±3	15±3										
		<table border="1"> <thead> <tr> <th>Step</th> <th>1</th> <th>2</th> </tr> </thead> <tbody> <tr> <td>Temp. (°C)</td> <td>-55+0/-3</td> <td>125+3/-0</td> </tr> <tr> <td>Time (min.)</td> <td>15±3</td> <td>15±3</td> </tr> </tbody> </table>		Step	1	2	Temp. (°C)	-55+0/-3	125+3/-0	Time (min.)	15±3	15±3
Step	1	2										
Temp. (°C)	-55+0/-3	125+3/-0										
Time (min.)	15±3	15±3										
		<table border="1"> <thead> <tr> <th>Step</th> <th>1</th> <th>2</th> </tr> </thead> <tbody> <tr> <td>Temp. (°C)</td> <td>-55+0/-3</td> <td>125+3/-0</td> </tr> <tr> <td>Time (min.)</td> <td>15±3</td> <td>15±3</td> </tr> </tbody> </table>		Step	1	2	Temp. (°C)	-55+0/-3	125+3/-0	Time (min.)	15±3	15±3
Step	1	2										
Temp. (°C)	-55+0/-3	125+3/-0										
Time (min.)	15±3	15±3										
		<table border="1"> <thead> <tr> <th>Step</th> <th>1</th> <th>2</th> </tr> </thead> <tbody> <tr> <td>Temp. (°C)</td> <td>-55+0/-3</td> <td>125+3/-0</td> </tr> <tr> <td>Time (min.)</td> <td>15±3</td> <td>15±3</td> </tr> </tbody> </table>		Step	1	2	Temp. (°C)	-55+0/-3	125+3/-0	Time (min.)	15±3	15±3
Step	1	2										
Temp. (°C)	-55+0/-3	125+3/-0										
Time (min.)	15±3	15±3										
		<table border="1"> <thead> <tr> <th>Step</th> <th>1</th> <th>2</th> </tr> </thead> <tbody> <tr> <td>Temp. (°C)</td> <td>-55+0/-3</td> <td>125+3/-0</td> </tr> <tr> <td>Time (min.)</td> <td>15±3</td> <td>15±3</td> </tr> </tbody> </table>		Step	1	2	Temp. (°C)	-55+0/-3	125+3/-0	Time (min.)	15±3	15±3
Step	1	2										
Temp. (°C)	-55+0/-3	125+3/-0										
Time (min.)	15±3	15±3										
		<table border="1"> <thead> <tr> <th>Step</th> <th>1</th> <th>2</th> </tr> </thead> <tbody> <tr> <td>Temp. (°C)</td> <td>-55+0/-3</td> <td>125+3/-0</td> </tr> <tr> <td>Time (min.)</td> <td>15±3</td> <td>15±3</td> </tr> </tbody> </table>		Step	1	2	Temp. (°C)	-55+0/-3	125+3/-0	Time (min.)	15±3	15±3
Step	1	2										
Temp. (°C)	-55+0/-3	125+3/-0										
Time (min.)	15±3	15±3										
		<table border="1"> <thead> <tr> <th>Step</th> <th>1</th> <th>2</th> </tr> </thead> <tbody> <tr> <td>Temp. (°C)</td> <td>-55+0/-3</td> <td>125+3/-0</td> </tr> <tr> <td>Time (min.)</td> <td>15±3</td> <td>15±3</td> </tr> </tbody> </table>		Step	1	2	Temp. (°C)	-55+0/-3	125+3/-0	Time (min.)	15±3	15±3
Step	1	2										
Temp. (°C)	-55+0/-3	125+3/-0										
Time (min.)	15±3	15±3										
		<table border="1"> <thead> <tr> <th>Step</th> <th>1</th> <th>2</th> </tr> </thead> <tbody> <tr> <td>Temp. (°C)</td> <td>-55+0/-3</td> <td>125+3/-0</td> </tr> <tr> <td>Time (min.)</td> <td>15±3</td> <td>15±3</td> </tr> </tbody> </table>		Step	1	2	Temp. (°C)	-55+0/-3	125+3/-0	Time (min.)	15±3	15±3
Step	1	2										
Temp. (°C)	-55+0/-3	125+3/-0										
Time (min.)	15±3	15±3										
		<table border="1"> <thead> <tr> <th>Step</th> <th>1</th> <th>2</th> </tr> </thead> <tbody> <tr> <td>Temp. (°C)</td> <td>-55+0/-3</td> <td>125+3/-0</td> </tr> <tr> <td>Time (min.)</td> <td>15±3</td> <td>15±3</td> </tr> </tbody> </table>		Step	1	2	Temp. (°C)	-55+0/-3	125+3/-0	Time (min.)	15±3	15±3
Step	1	2										
Temp. (°C)	-55+0/-3	125+3/-0										
Time (min.)	15±3	15±3										
		<table border="1"> <thead> <tr> <th>Step</th> <th>1</th> <th>2</th> </tr> </thead> <tbody> <tr> <td>Temp. (°C)</td> <td>-55+0/-3</td> <td>125+3/-0</td> </tr> <tr> <td>Time (min.)</td> <td>15±3</td> <td>15±3</td> </tr> </tbody> </table>		Step	1	2	Temp. (°C)	-55+0/-3	125+3/-0	Time (min.)	15±3	15±3
Step	1	2										
Temp. (°C)	-55+0/-3	125+3/-0										
Time (min.)	15±3	15±3										
		<table border="1"> <thead> <tr> <th>Step</th> <th>1</th> <th>2</th> </tr> </thead> <tbody> <tr> <td>Temp. (°C)</td> <td>-55+0/-3</td> <td>125+3/-0</td> </tr> <tr> <td>Time (min.)</td> <td>15±3</td> <td>15±3</td> </tr> </tbody> </table>		Step	1	2	Temp. (°C)	-55+0/-3	125+3/-0	Time (min.)	15±3	15±3
Step	1	2										
Temp. (°C)	-55+0/-3	125+3/-0										
Time (min.)	15±3	15±3										
		<table border="1"> <thead> <tr> <th>Step</th> <th>1</th> <th>2</th> </tr> </thead> <tbody> <tr> <td>Temp. (°C)</td> <td>-55+0/-3</td> <td>125+3/-0</td> </tr> <tr> <td>Time (min.)</td> <td>15±3</td> <td>15±3</td> </tr> </tbody> </table>		Step	1	2	Temp. (°C)	-55+0/-3	125+3/-0	Time (min.)	15±3	15±3
Step	1	2										
Temp. (°C)	-55+0/-3	125+3/-0										
Time (min.)	15±3	15±3										
		<table border="1"> <thead> <tr> <th>Step</th> <th>1</th> <th>2</th> </tr> </thead> <tbody> <tr> <td>Temp. (°C)</td> <td>-55+0/-3</td> <td>125+3/-0</td> </tr> <tr> <td>Time (min.)</td> <td>15±3</td> <td>15±3</td> </tr> </tbody> </table>		Step	1	2	Temp. (°C)	-55+0/-3	125+3/-0	Time (min.)	15±3	15±3
Step	1	2										
Temp. (°C)	-55+0/-3	125+3/-0										
Time (min.)	15±3	15±3										
		<table border="1"> <thead> <tr> <th>Step</th> <th>1</th> <th>2</th> </tr> </thead> <tbody> <tr> <td>Temp. (°C)</td> <td>-55+0/-3</td> <td>125+3/-0</td> </tr> <tr> <td>Time (min.)</td> <td>15±3</td> <td>15±3</td> </tr> </tbody> </table>		Step	1	2	Temp. (°C)	-55+0/-3	125+3/-0	Time (min.)	15±3	15±3
Step	1	2										
Temp. (°C)	-55+0/-3	125+3/-0										
Time (min.)	15±3	15±3										
		<table border="1"> <thead> <tr> <th>Step</th> <th>1</th> <th>2</th> </tr> </thead> <tbody> <tr> <td>Temp. (°C)</td> <td>-55+0/-3</td> <td>125+3/-0</td> </tr> <tr> <td>Time (min.)</td> <td>15±3</td> <td>15±3</td> </tr> </tbody> </table>		Step	1	2	Temp. (°C)	-55+0/-3	125+3/-0	Time (min.)	15±3	15±3
Step	1	2										
Temp. (°C)	-55+0/-3	125+3/-0										
Time (min.)	15±3	15±3										
		<table border="1"> <thead> <tr> <th>Step</th> <th>1</th> <th>2</th> </tr> </thead> <tbody> <tr> <td>Temp. (°C)</td> <td>-55+0/-3</td> <td>125+3/-0</td> </tr> <tr> <td>Time (min.)</td> <td>15±3</td> <td>15±3</td> </tr> </tbody> </table>		Step	1	2	Temp. (°C)	-55+0/-3	125+3/-0	Time (min.)	15±3	15±3
Step	1	2										
Temp. (°C)	-55+0/-3	125+3/-0										
Time (min.)	15±3	15±3										
		<table border="1"> <thead> <tr> <th>Step</th> <th>1</th> <th>2</th> </tr> </thead> <tbody> <tr> <td>Temp. (°C)</td> <td>-55+0/-3</td> <td>125+3/-0</td> </tr> <tr> <td>Time (min.)</td> <td>15±3</td> <td>15±3</td> </tr> </tbody> </table>		Step	1	2	Temp. (°C)	-55+0/-3	125+3/-0	Time (min.)	15±3	15±3
Step	1	2										
Temp. (°C)	-55+0/-3	125+3/-0										
Time (min.)	15±3	15±3										
		<table border="1"> <thead> <tr> <th>Step</th> <th>1</th> <th>2</th> </tr> </thead> <tbody> <tr> <td>Temp. (°C)</td> <td>-55+0/-3</td> <td>125+3/-0</td> </tr> <tr> <td>Time (min.)</td> <td>15±3</td> <td>15±3</td> </tr> </tbody> </table>		Step	1	2	Temp. (°C)	-55+0/-3	125+3/-0	Time (min.)	15±3	15±3
Step	1	2										
Temp. (°C)	-55+0/-3	125+3/-0										
Time (min.)	15±3	15±3										
		<table border="1"> <thead> <tr> <th>Step</th> <th>1</th> <th>2</th> </tr> </thead> <tbody> <tr> <td>Temp. (°C)</td> <td>-55+0/-3</td> <td>125+3/-0</td> </tr> <tr> <td>Time (min.)</td> <td>15±3</td> <td>15±3</td> </tr> </tbody> </table>		Step	1	2	Temp. (°C)	-55+0/-3	125+3/-0	Time (min.)	15±3	15±3
Step	1	2										
Temp. (°C)	-55+0/-3	125+3/-0										
Time (min.)	15±3	15±3										
		<table border="1"> <thead> <tr> <th>Step</th> <th>1</th> <th>2</th> </tr> </thead> <tbody> <tr> <td>Temp. (°C)</td> <td>-55+0/-3</td> <td>125+3/-0</td> </tr> <tr> <td>Time (min.)</td> <td>15±3</td> <td>15±3</td> </tr> </tbody> </table>		Step	1	2	Temp. (°C)	-55+0/-3	125+3/-0	Time (min.)	15±3	15±3
Step	1	2										
Temp. (°C)	-55+0/-3	125+3/-0										
Time (min.)	15±3	15±3										
		<table border="1"> <thead> <tr> <th>Step</th> <th>1</th> <th>2</th> </tr> </thead> <tbody> <tr> <td>Temp. (°C)</td> <td>-55+0/-3</td> <td>125+3/-0</td> </tr> <tr> <td>Time (min.)</td> <td>15±3</td> <td>15±3</td> </tr> </tbody> </table>		Step	1	2	Temp. (°C)	-55+0/-3	125+3/-0	Time (min.)	15±3	15±3
Step	1	2										
Temp. (°C)	-55+0/-3	125+3/-0										
Time (min.)	15±3	15±3										
		<table border="1"> <thead> <tr> <th>Step</th> <th>1</th> <th>2</th> </tr> </thead> <tbody> <tr> <td>Temp. (°C)</td> <td>-55+0/-3</td> <td>125+3/-0</td> </tr> <tr> <td>Time (min.)</td> <td>15±3</td> <td>15±3</td> </tr> </tbody> </table>		Step	1	2	Temp. (°C)	-55+0/-3	125+3/-0	Time (min.)	15±3	15±3
Step	1	2										
Temp. (°C)	-55+0/-3	125+3/-0										
Time (min.)	15±3	15±3										
		<table border="1"> <thead> <tr> <th>Step</th> <th>1</th> <th>2</th> </tr> </thead> <tbody> <tr> <td>Temp. (°C)</td> <td>-55+0/-3</td> <td>125+3/-0</td> </tr> <tr> <td>Time (min.)</td> <td>15±3</td> <td>15±3</td> </tr> </tbody> </table>		Step	1	2	Temp. (°C)	-55+0/-3	125+3/-0	Time (min.)	15±3	15±3
Step	1	2										
Temp. (°C)	-55+0/-3	125+3/-0										
Time (min.)	15±3	15±3										
		<table border="1"> <thead> <tr> <th>Step</th> <th>1</th> <th>2</th> </tr> </thead> <tbody> <tr> <td>Temp. (°C)</td> <td>-55+0/-3</td> <td>125+3/-0</td> </tr> <tr> <td>Time (min.)</td> <td>15±3</td> <td>15±3</td> </tr> </tbody> </table>		Step	1	2	Temp. (°C)	-55+0/-3	125+3/-0	Time (min.)	15±3	15±3
Step	1	2										
Temp. (°C)	-55+0/-3	125+3/-0										
Time (min.)	15±3	15±3										
		<table border="1"> <thead> <tr> <th>Step</th> <th>1</th> <th>2</th> </tr> </thead> <tbody> <tr> <td>Temp. (°C)</td> <td>-55+0/-3</td> <td>125+3/-0</td> </tr> <tr> <td>Time (min.)</td> <td>15±3</td> <td>15±3</td> </tr> </tbody> </table>		Step	1	2	Temp. (°C)	-55+0/-3	125+3/-0	Time (min.)	15±3	15±3
Step	1	2										
Temp. (°C)	-55+0/-3	125+3/-0										
Time (min.)	15±3	15±3										
		<table border="1"> <thead> <tr> <th>Step</th> <th>1</th> <th>2</th> </tr> </thead> <tbody> <tr> <td>Temp. (°C)</td> <td>-55+0/-3</td> <td>125+3/-0</td> </tr> <tr> <td>Time (min.)</td> <td>15±3</td> <td>15±3</td> </tr> </tbody> </table>		Step	1	2	Temp. (°C)	-55+0/-3	125+3/-0	Time (min.)	15±3	15±3
Step	1	2										
Temp. (°C)	-55+0/-3	125+3/-0										
Time (min.)	15±3	15±3										
		<table border="1"> <thead> <tr> <th>Step</th> <th>1</th> <th>2</th> </tr> </thead> <tbody> <tr> <td>Temp. (°C)</td> <td>-55+0/-3</td> <td>125+3/-0</td> </tr> <tr> <td>Time (min.)</td> <td>15±3</td> <td>15±3</td> </tr> </tbody> </table>		Step	1	2	Temp. (°C)	-55+0/-3	125+3/-0	Time (min.)	15±3	15±3
Step	1	2										
Temp. (°C)	-55+0/-3	125+3/-0										
Time (min.)	15±3	15±3										
		<table border="1"> <thead> <tr> <th>Step</th> <th>1</th> <th>2</th> </tr> </thead> <tbody> <tr> <td>Temp. (°C)</td> <td>-55+0/-3</td> <td>125+3/-0</td> </tr> <tr> <td>Time (min.)</td> <td>15±3</td> <td>15±3</td> </tr> </tbody> </table>		Step	1	2	Temp. (°C)	-55+0/-3	125+3/-0	Time (min.)	15±3	15±3
Step	1	2										
Temp. (°C)	-55+0/-3	125+3/-0										
Time (min.)	15±3	15±3										
		<table border="1"> <thead> <tr> <th>Step</th> <th>1</th> <th>2</th> </tr> </thead> <tbody> <tr> <td>Temp. (°C)</td> <td>-55+0/-3</td> <td>125+3/-0</td> </tr> <tr> <td>Time (min.)</td> <td>15±3</td> <td>15±3</td> </tr> </tbody> </table>		Step	1	2	Temp. (°C)	-55+0/-3	125+3/-0	Time (min.)	15±3	15±3
Step	1	2										
Temp. (°C)	-55+0/-3	125+3/-0										
Time (min.)	15±3	15±3										
		<table border="1"> <thead> <tr> <th>Step</th> <th>1</th> <th>2</th> </tr> </thead> <tbody> <tr> <td>Temp. (°C)</td> <td>-55+0/-3</td> <td>125+3/-0</td> </tr> <tr> <td>Time (min.)</td> <td>15±3</td> <td>15±3</td> </tr> </tbody> </table>		Step	1	2	Temp. (°C)	-55+0/-3	125+3/-0	Time (min.)	15±3	15±3
Step	1	2										
Temp. (°C)	-55+0/-3	125+3/-0										
Time (min.)	15±3	15±3										
		<table border="1"> <thead> <tr> <th>Step</th> <th>1</th> <th>2</th> </tr> </thead> <tbody> <tr> <td>Temp. (°C)</td> <td>-55+0/-3</td> <td>125+3/-0</td> </tr> <tr> <td>Time (min.)</td> <td>15±3</td> <td>15±3</td> </tr> </tbody> </table>		Step	1	2	Temp. (°C)	-55+0/-3	125+3/-0	Time (min.)	15±3	15±3
Step	1	2										
Temp. (°C)	-55+0/-3	125+3/-0										
Time (min.)	15±3	15±3										
		<table border="1"> <thead> <tr> <th>Step</th> <th>1</th> <th>2</th> </tr> </thead> <tbody> <tr> <td>Temp. (°C)</td> <td>-55+0/-3</td> <td>125+3/-0</td> </tr> <tr> <td>Time (min.)</td> <td>15±3</td> <td>15±3</td> </tr> </tbody> </table>		Step	1	2	Temp. (°C)	-55+0/-3	125+3/-0	Time (min.)	15±3	15±3
Step	1	2										
Temp. (°C)	-55+0/-3	125+3/-0										
Time (min.)	15±3	15±3										
		<table border="1"> <thead> <tr> <th>Step</th> <th>1</th> <th>2</th> </tr> </thead> <tbody> <tr> <td>Temp. (°C)</td> <td>-55+0/-3</td> <td>125+3/-0</td> </tr> <tr> <td>Time (min.)</td> <td>15±3</td> <td>15±3</td> </tr> </tbody> </table>		Step	1	2	Temp. (°C)	-55+0/-3	125+3/-0	Time (min.)	15±3	15±3
Step	1	2										
Temp. (°C)	-55+0/-3	125+3/-0										
Time (min.)	15±3	15±3										
		<table border="1"> <thead> <tr> <th>Step</th> <th>1</th> <th>2</th> </tr> </thead> <tbody> <tr> <td>Temp. (°C)</td> <td>-55+0/-3</td> <td>125+3/-0</td> </tr> <tr> <td>Time (min.)</td> <td>15±3</td> <td>15±3</td> </tr> </tbody> </table>		Step	1	2	Temp. (°C)	-55+0/-3	125+3/-0	Time (min.)	15±3	15±3
Step	1	2										
Temp. (°C)	-55+0/-3	125+3/-0										
Time (min.)	15±3	15±3										
		<table border="1"> <thead> <tr> <th>Step</th> <th>1</th> <th>2</th> </tr> </thead> <tbody> <tr> <td>Temp. (°C)</td> <td>-55+0/-3</td> <td>125+3/-0</td> </tr> <tr> <td>Time (min.)</td> <td>15±3</td> <td>15±3</td> </tr> </tbody> </table>		Step	1	2	Temp. (°C)	-55+0/-3	125+3/-0	Time (min.)	15±3	15±3
Step	1	2										
Temp. (°C)	-55+0/-3	125+3/-0										
Time (min.)	15±3	15±3										
		<table border="1"> <thead> <tr> <th>Step</th> <th>1</th> <th>2</th> </tr> </thead> <tbody> <tr> <td>Temp. (°C)</td> <td>-55+0/-3</td> <td>125+3/-0</td> </tr> <tr> <td>Time (min.)</td> <td>15±3</td> <td>15±3</td> </tr> </tbody> </table>		Step	1	2	Temp. (°C)	-55+0/-3	125+3/-0	Time (min.)	15±3	15±3
Step	1	2										
Temp. (°C)	-55+0/-3	125+3/-0										
Time (min.)	15±3	15±3										
		<table border="1"> <thead> <tr> <th>Step</th> <th>1</th> <th>2</th> </tr> </thead> <tbody> <tr> <td>Temp. (°C)</td> <td>-55+0/-3</td> <td>125+3/-0</td> </tr> <tr> <td>Time (min.)</td> <td>15±3</td> <td>15±3</td> </tr> </tbody> </table>		Step	1	2	Temp. (°C)	-55+0/-3	125+3/-0	Time (min.)	15±3	15±3
Step	1	2										
Temp. (°C)	-55+0/-3	125+3/-0										
Time (min.)	15±3	15±3										
		<table border="1"> <thead> <tr> <th>Step</th> <th>1</th> <th>2</th> </tr> </thead> <tbody> <tr> <td>Temp. (°C)</td> <td>-55+0/-3</td> <td>125+3/-0</td> </tr> <tr> <td>Time (min.)</td> <td>15±3</td> <td>15±3</td> </tr> </tbody> </table>		Step	1	2	Temp. (°C)	-55+0/-3	125+3/-0	Time (min.)	15±3	15±3
Step	1	2										
Temp. (°C)	-55+0/-3	125+3/-0										
Time (min.)	15±3	15±3										
		<table border="1"> <thead> <tr> <th>Step</th> <th>1</th> <th>2</th> </tr> </thead> <tbody> <tr> <td>Temp. (°C)</td> <td>-55+0/-3</td> <td>125+3/-0</td> </tr> <tr> <td>Time (min.)</td> <td>15±3</td> <td>15±3</td> </tr> </tbody> </table>		Step	1	2	Temp. (°C)	-55+0/-3	125+3/-0	Time (min.)	15±3	15±3
Step	1	2										
Temp. (°C)	-55+0/-3	125+3/-0										
Time (min.)	15±3	15±3										
		<table border="1"> <thead> <tr> <th>Step</th> <th>1</th> <th>2</th> </tr> </thead> <tbody> <tr> <td>Temp. (°C)</td> <td>-55+0/-3</td> <td>125+3/-0</td> </tr> <tr> <td>Time (min.)</td> <td>15±3</td> <td>15±3</td> </tr> </tbody> </table>		Step	1	2	Temp. (°C)	-55+0/-3	125+3/-0	Time (min.)	15±3	15±3
Step	1	2										
Temp. (°C)	-55+0/-3	125+3/-0										
Time (min.)	15±3	15±3										
		<table border="1"> <thead> <tr> <th>Step</th> <th>1</th> <th>2</th> </tr> </thead> <tbody> <tr> <td>Temp. (°C)</td> <td>-55+0/-3</td> <td>125+3/-0</td> </tr> <tr> <td>Time (min.)</td> <td>15±3</td> <td>15±3</td> </tr> </tbody> </table>		Step	1	2	Temp. (°C)	-55+0/-3	125+3/-0	Time (min.)	15±3	15±3
Step	1	2										
Temp. (°C)	-55+0/-3	125+3/-0										
Time (min.)	15±3	15±3										
		<table border="1"> <thead> <tr> <th>Step</th> <th>1</th> <th>2</th> </tr> </thead> <tbody> <tr> <td>Temp. (°C)</td> <td>-55+0/-3</td> <td>125+3/-0</td> </tr> <tr> <td>Time (min.)</td> <td>15±3</td> <td>15±3</td> </tr> </tbody> </table>		Step	1	2	Temp. (°C)	-55+0/-3	125+3/-0	Time (min.)	15±3	15±3
Step	1	2										
Temp. (°C)	-55+0/-3	125+3/-0										
Time (min.)	15±3	15±3										
		<table border="1"> <thead> <tr> <th>Step</th> <th>1</th> <th>2</th> </tr> </thead> <tbody> <tr> <td>Temp. (°C)</td> <td>-55+0/-3</td> <td>125+3/-0</td> </tr> <tr> <td>Time (min.)</td> <td>15±3</td> <td>15±3</td> </tr> </tbody> </table>		Step	1	2	Temp. (°C)	-55+0/-3	125+3/-0	Time (min.)	15±3	15±3
Step	1	2										
Temp. (°C)	-55+0/-3	125+3/-0										
Time (min.)	15±3	15±3										
		<table border="1"> <thead> <tr> <th>Step</th> <th>1</th> <th>2</th> </tr> </thead> <tbody> <tr> <td>Temp. (°C)</td> <td>-55+0/-3</td> <td>125+3/-0</td> </tr> <tr> <td>Time (min.)</td> <td>15±3</td> <td>15±3</td> </tr> </tbody> </table>		Step	1	2	Temp. (°C)	-55+0/-3	125+3/-0	Time (min.)	15±3	15±3
Step	1	2										
Temp. (°C)	-55+0/-3	125+3/-0										
Time (min.)	15±3	15±3										
		<table border="1"> <thead> <tr> <th>Step</th> <th>1</th> <th>2</th> </tr> </thead> <tbody> <tr> <td>Temp. (°C)</td> <td>-55+0/-3</td> <td>125+3/-0</td> </tr> <tr> <td>Time (min.)</td> <td>15±3</td> <td>15±3</td> </tr> </tbody> </table>		Step	1	2	Temp. (°C)	-55+0/-3	125+3/-0	Time (min.)	15±3	15±3
Step	1	2										
Temp. (°C)	-55+0/-3	125+3/-0										
Time (min.)	15±3	15±3										
		<table border="1"> <thead> <tr> <th>Step</th> <th>1</th> <th>2</th> </tr> </thead> <tbody> <tr> <td>Temp. (°C)</td> <td>-55+0/-3</td> <td>125+3/-0</td> </tr> <tr> <td>Time (min.)</td> <td>15±3</td> <td>15±3</td> </tr> </tbody> </table>		Step	1	2	Temp. (°C)	-55+0/-3	125+3/-0	Time (min.)	15±3	15±3
Step	1	2										
Temp. (°C)	-55+0/-3	125+3/-0										
Time (min.)	15±3	15±3										
		<table border="1"> <thead> <tr> <th>Step</th> <th>1</th> <th>2</th> </tr> </thead> <tbody> <tr> <td>Temp. (°C)</td> <td>-55+0/-3</td> <td>125+3/-0</td> </tr> <tr> <td>Time (min.)</td> <td>15±3</td> <td>15±3</td> </tr> </tbody> </table>		Step	1	2	Temp. (°C)	-55+0/-3	125+3/-0	Time (min.)	15±3	15±3
Step	1	2										
Temp. (°C)	-55+0/-3	125+3/-0										
Time (min.)	15±3	15±3										
		<table border="1"> <thead> <tr> <th>Step</th> <th>1</th> <th>2</th> </tr> </thead> <tbody> <tr> <td>Temp. (°C)</td> <td>-55+0/-3</td> <td>125+3/-0</td> </tr> <tr> <td>Time (min.)</td> <td>15±3</td> <td>15±3</td> </tr> </tbody> </table>		Step	1	2	Temp. (°C)	-55+0/-3	125+3/-0	Time (min.)	15±3	15±3
Step	1	2										
Temp. (°C)	-55+0/-3	125+3/-0										
Time (min.)	15±3	15±3										
		<table border="1"> <thead> <tr> <th>Step</th> <th>1</th> <th>2</th> </tr> </thead> <tbody> <tr> <td>Temp. (°C)</td> <td>-55+0/-3</td> <td>125+3/-0</td> </tr> <tr> <td>Time (min.)</td> <td>15±3</td> <td>15±3</td> </tr> </tbody> </table>		Step	1	2	Temp. (°C)	-55+0/-3	125+3/-0	Time (min.)	15±3	15±3
Step	1	2										
Temp. (°C)	-55+0/-3	125+3/-0										
Time (min.)	15±3	15±3										
		<table border="1"> <thead> <tr> <th>Step</th> <th>1</th> <th>2</th> </tr> </thead> <tbody> <tr> <td>Temp. (°C)</td> <td>-55+0/-3</td> <td>125+3/-0</td> </tr> <tr> <td>Time (min.)</td> <td>15±3</td> <td>15±3</td> </tr> </tbody> </table>		Step	1	2	Temp. (°C)	-55+0/-3	125+3/-0	Time (min.)	15±3	15±3
Step	1	2										
Temp. (°C)	-55+0/-3	125+3/-0										
Time (min.)	15±3	15±3										
		<table border="1"> <thead> <tr> <th>Step</th> <th>1</th> <th>2</th> </tr> </thead> <tbody> <tr> <td>Temp. (°C)</td> <td>-55+0/-3</td> <td>125+3/-0</td> </tr> <tr> <td>Time (min.)</td> <td>15±3</td> <td>15±3</td> </tr> </tbody> </table>		Step	1	2	Temp. (°C)	-55+0/-3	125+3/-0	Time (min.)	15±3	15±3
Step	1	2										
Temp. (°C)	-55+0/-3	125+3/-0										
Time (min.)	15±3	15±3										
		<table border="1"> <thead> <tr> <th>Step</th> <th>1</th> <th>2</th> </tr> </thead> <tbody> <tr> <td>Temp. (°C)</td> <td>-55+0/-3</td> <td>125+3/-0</td> </tr> <tr> <td>Time (min.)</td> <td>15±3</td> <td>15±3</td> </tr> </tbody> </table>		Step	1	2	Temp. (°C)	-55+0/-3	125+3/-0	Time (min.)	15±3	15±3
Step	1	2										
Temp. (°C)	-55+0/-3	125+3/-0										
Time (min.)	15±3	15±3										
		<table border="1"> <thead> <tr> <th>Step</th> <th>1</th> <th>2</th> </tr> </thead> <tbody> <tr> <td>Temp. (°C)</td> <td>-55+0/-3</td> <td>125+3/-0</td> </tr> <tr> <td>Time (min.)</td> <td>15±3</td> <td>15±3</td> </tr> </tbody> </table>		Step	1	2	Temp. (°C)	-55+0/-3	125+3/-0	Time (min.)	15±3	15±3
Step	1	2										
Temp. (°C)	-55+0/-3	125+3/-0										
Time (min.)	15±3	15±3										
		<table border="1"> <thead> <tr> <th>Step</th> <th>1</th> <th>2</th> </tr> </thead> <tbody> <tr> <td>Temp. (°C)</td> <td>-55+0/-3</td> <td>125+3/-0</td> </tr> <tr> <td>Time (min.)</td> <td>15±3</td> <td>15±3</td> </tr> </tbody> </table>		Step	1	2	Temp. (°C)	-55+0/-3	125+3/-0	Time (min.)	15±3	15±3
Step	1	2										
Temp. (°C)	-55+0/-3	125+3/-0										
Time (min.)	15±3	15±3										
		<table border="1"> <thead> <tr> <th>Step</th> <th>1</th> <th>2</th> </tr> </thead> <tbody> <tr> <td>Temp. (°C)</td> <td>-55+0/-3</td> <td>125+3/-0</td> </tr> <tr> <td>Time (min.)</td> <td>15±3</td> <td>15±3</td> </tr> </tbody> </table>		Step	1	2	Temp. (°C)	-55+0/-3	125+3/-0	Time (min.)	15±3	15±3
Step	1	2										
Temp. (°C)	-55+0/-3	125+3/-0										
Time (min.)	15±3	15±3										
		<table border="1"> <thead> <tr> <th>Step</th> <th>1</th> <th>2</th> </tr> </thead> <tbody> <tr> <td>Temp. (°C)</td> <td>-55+0/-3</td> <td>125+3/-0</td> </tr> <tr> <td>Time (min.)</td> <td>15±3</td> <td>15±3</td> </tr> </tbody> </table>		Step	1	2	Temp. (°C)	-55+0/-3	125+3/-0	Time (min.)	15±3	15±3
Step	1	2										
Temp. (°C)	-55+0/-3	125+3/-0										
Time (min.)	15±3	15±3										
		<table border="1"> <thead> <tr> <th>Step</th> <th>1</th> <th>2</th> </tr> </thead> <tbody> <tr> <td>Temp. (°C)</td> <td>-55+0/-3</td> <td>125+3/-0</td> </tr> <tr> <td>Time (min.)</td> <td>15±3</td> <td>15±3</td> </tr> </tbody> </table>		Step	1	2	Temp. (°C)	-55+0/-3	125+3/-0	Time (min.)	15±3	15±3
Step	1	2										
Temp. (°C)	-55+0/-3	125+3/-0										
Time (min.)	15±3	15±3										
		<table border="1"> <thead> <tr> <th>Step</th> <th>1</th> <th>2</th> </tr> </thead> <tbody> <tr> <td>Temp. (°C)</td> <td>-55+0/-3</td> <td>125+3/-0</td> </tr> <tr> <td>Time (min.)</td> <td>15±3</td> <td>15±3</td> </tr> </tbody> </table>		Step	1	2	Temp. (°C)	-55+0/-3	125+3/-0	Time (min.)	15±3	15±3
Step	1	2										
Temp. (°C)	-55+0/-3	125+3/-0										
Time (min.)	15±3	15±3										
		<table border="1"> <thead> <tr> <th>Step</th> <th>1</th> <th>2</th> </tr> </thead> <tbody> <tr> <td>Temp. (°C)</td> <td>-55+0/-3</td> <td>125+3/-0</td> </tr> <tr> <td>Time (min.)</td> <td>15±3</td> <td>15±3</td> </tr> </tbody> </table>		Step	1	2	Temp. (°C)	-55+0/-3	125+3/-0	Time (min.)	15±3	15±3
Step	1	2										
Temp. (°C)	-55+0/-3	125+3/-0										
Time (min.)	15±3	15±3										
		<table border="1"> <thead> <tr> <th>Step</th> <th>1</th> <th>2</th> </tr> </thead> <tbody> <tr> <td>Temp. (°C)</td> <td>-55+0/-3</td> <td>125+3/-0</td> </tr> <tr> <td>Time (min.)</td> <td>15±3</td> <td>15±3</td> </tr> </tbody> </table>		Step	1	2	Temp. (°C)	-55+0/-3	125+3/-0	Time (min.)	15±3	15±3
Step	1	2										
Temp. (°C)	-55+0/-3	125+3/-0										
Time (min.)	15±3	15±3										
		<table border="1"> <thead> <tr> <th>Step</th> <th>1</th> <th>2</th> </tr> </thead> <tbody> <tr> <td>Temp. (°C)</td> <td>-55+0/-3</td> <td>125+3/-0</td> </tr> <tr> <td>Time (min.)</td> <td>15±3</td> <td>15±3</td> </tr> </tbody> </table>		Step	1	2	Temp. (°C)	-55+0/-3	125+3/-0	Time (min.)	15±3	15±3
Step	1	2										
Temp. (°C)	-55+0/-3	125+3/-0										
Time (min.)	15±3	15±3										
		<table border="1"> <thead> <tr> <th>Step</th> <th>1</th> <th>2</th> </tr> </thead> <tbody> <tr> <td>Temp. (°C)</td> <td>-55+0/-3</td> <td>125+3/-0</td> </tr> <tr> <td>Time (min.)</td> <td>15±3</td> <td>15±3</td> </tr> </tbody> </table>		Step	1	2	Temp. (°C)	-55+0/-3	125+3/-0	Time (min.)	15±3	15±3
Step	1	2										
Temp. (°C)	-55+0/-3	125+3/-0										
Time (min.)	15±3	15±3										
		<table border="1"> <thead> <tr> <th>Step</th> <th>1</th> <th>2</th> </tr> </thead> <tbody> <tr> <td>Temp. (°C)</td> <td>-55+0/-3</td> <td>125+3/-0</td> </tr> <tr> <td>Time (min.)</td> <td>15±3</td> <td>15±3</td> </tr> </tbody> </table>		Step	1	2	Temp. (°C)	-55+0/-3	125+3/-0	Time (min.)	15±3	15±3
Step	1	2										
Temp. (°C)	-55+0/-3	125+3/-0										
Time (min.)	15±3	15±3										
		<table border="1"> <thead> <tr> <th>Step</th> <th>1</th> <th></th></tr></thead></table>		Step	1							
Step	1											

Reference only

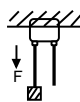
No.	Test Item		Specification	Test Method (Compliant Standard:AEC-Q200)												
15	ESD	Appearance	No defects or abnormalities.	Per AEC-Q200-002												
		Capacitance	Within the specified tolerance.													
		Q	$30\text{pF} \leq C : Q \geq 1,000$ $30\text{pF} > C : Q \geq 400+20C$ C : Nominal Capacitance (pF)													
		I.R.	More than 10,000MΩ or 500 MΩ·μF (Whichever is smaller)													
16	Solderability		Lead wire should be soldered with uniform coating on the axial direction over 95% of the circumferential direction.	Should be placed into steam aging for 8h±15 min. The terminal of capacitor is dipped into a solution of rosin ethanol (25% rosin in weight proportion). Immerse in solder solution for 2±0.5 seconds. In both cases the depth of dipping is up to about 1.5 to 2mm from the terminal body. Temp. of solder : 245±5°C (Sn-3.0Ag-0.5Cu)												
17	Electrical Characterization	Appearance	No defects or abnormalities.	Visual inspection.												
		Capacitance	Within the specified tolerance.	The capacitance, Q should be measured at 25°C at the frequency and voltage shown in the table. <table border="1" style="margin-left: auto; margin-right: auto;"> <thead> <tr> <th>Nominal Cap.</th> <th>Frequency</th> <th>Voltage</th> </tr> </thead> <tbody> <tr> <td>C ≤ 1000pF</td> <td>1±0.1MHz</td> <td>AC0.5 to 5V(r.m.s.)</td> </tr> <tr> <td>C > 1000pF</td> <td>1±0.1kHz</td> <td>AC1±0.2V(r.m.s.)</td> </tr> </tbody> </table>	Nominal Cap.	Frequency	Voltage	C ≤ 1000pF	1±0.1MHz	AC0.5 to 5V(r.m.s.)	C > 1000pF	1±0.1kHz	AC1±0.2V(r.m.s.)			
		Nominal Cap.	Frequency		Voltage											
		C ≤ 1000pF	1±0.1MHz		AC0.5 to 5V(r.m.s.)											
		C > 1000pF	1±0.1kHz	AC1±0.2V(r.m.s.)												
Q	$30\text{pF} \leq C : Q \geq 1,000$ $30\text{pF} > C : Q \geq 400+20C$ C : Nominal Capacitance (pF)															
I.R.	Between Terminals	10,000MΩ or 500MΩ·μF min. (Whichever is smaller)	The insulation resistance should be measured with a DC voltage not exceeding the rated voltage at 25 °C within 2 min. of charging.													
Dielectric Strength	Between Terminals	No defects or abnormalities.	The capacitor should not be damaged when DC voltage of 300% of the rated voltage is applied between the terminations for 1 to 5 seconds. (Charge/Discharge current ≤ 50mA.)													
Terminal To External Resin	Terminal To External Resin	No defects or abnormalities.	The capacitor is placed in a container with metal balls of 1mm diameter so that each terminal, short-circuit is kept approximately 2mm from the balls, and 250% of the rated DC voltage is impressed for 1 to 5 seconds between capacitor terminals and metal balls. (Charge/Discharge current ≤ 50mA.)													
18	Terminal Strength	Tensile Strength	Termination not to be broken or loosened.	As in the figure, fix the capacitor body, apply the force gradually to each lead in the radial direction of the capacitor until reaching 10N and then keep the force applied for 10±1 seconds. 												
		Bending Strength	Termination not to be broken or loosened.	Each lead wire should be subjected to a force of 2.5N and then be bent 90° at the point of egress in one direction. Each wire is then returned to the original position and bent 90° in the opposite direction at the rate of one bend per 2 to 3 seconds.												
19	Capacitance Temperature Characteristics		Within the specified Tolerance 25°C to 125°C : 0±30ppm/°C -55°C to 25°C : 0+30/-72ppm/°C	The capacitance change should be measured after 5min. at each specified temperature step. <table border="1" style="margin-left: auto; margin-right: auto;"> <thead> <tr> <th>Step</th> <th>Temperature(°C)</th> </tr> </thead> <tbody> <tr> <td>1</td> <td>25±2</td> </tr> <tr> <td>2</td> <td>-55±3</td> </tr> <tr> <td>3</td> <td>25±2</td> </tr> <tr> <td>4</td> <td>125±3</td> </tr> <tr> <td>5</td> <td>25±2</td> </tr> </tbody> </table> <p>The temperature coefficient is determined using the capacitance measured in step 3 as a reference. When cycling the temperature sequentially from step 1 through 5 (-55°C to 125°C) the capacitance should be within the specified tolerance for the temperature coefficient and capacitance change as Table A. The capacitance drift is calculated by dividing the differences between the maximum and minimum measured values in the step 1, 3 and 5 by the capacitance value in step 3.</p>	Step	Temperature(°C)	1	25±2	2	-55±3	3	25±2	4	125±3	5	25±2
Step	Temperature(°C)															
1	25±2															
2	-55±3															
3	25±2															
4	125±3															
5	25±2															

* "room condition" Temperature : 15 to 35°C, Relative humidity : 45 to 75%, Atmosphere pressure : 86 to 106kPa

6. Packing specification

- Bulk type (Package : B)

The size of packing case and packing way



$$\text{The number of packing} = {}^*1 \text{ Packing quantity} \times {}^*2 n$$

*1 : Please refer to [Part number list].

*2 : Standard n = 20 (bag)

Note)

The outer package and the number of outer packing be changed by the order getting amount.

• Ammo pack taping type (Package : A)

- The tape with capacitors is packed zigzag into a case.
- There should be 3 pitches and over without capacitors in leader and trailer.

The size of packing case and packing way

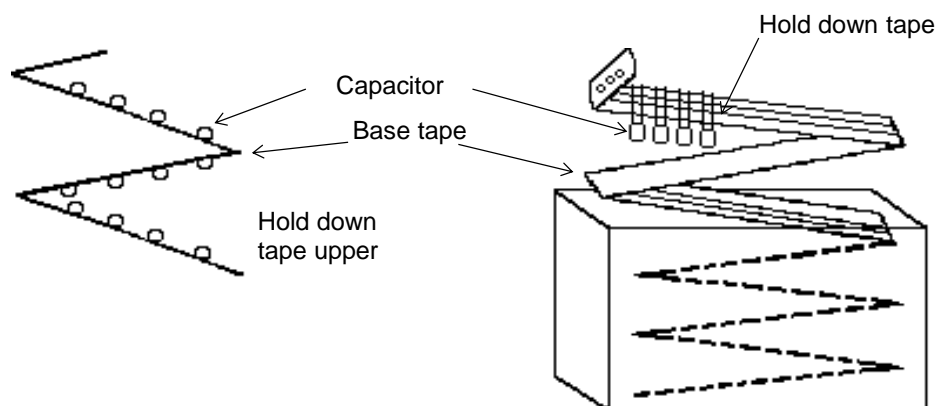

7. Taping specification

7-1. Dimension of capacitors on tape

Straight taping type < Lead Style : DB >

Pitch of component 12.7mm / Lead spacing 2.5mm

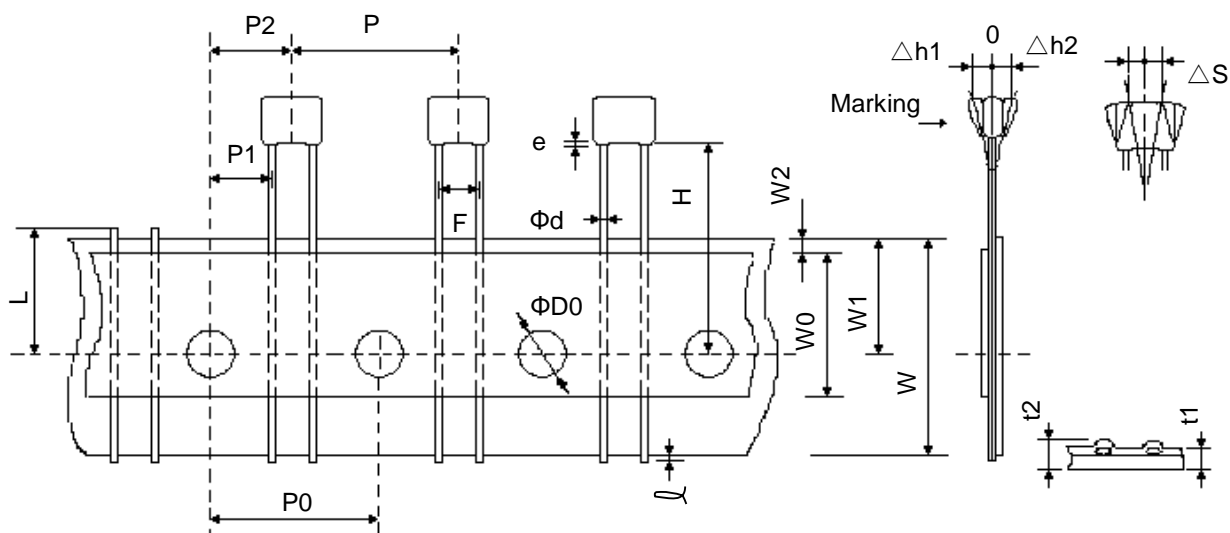

Unit : mm

Item	Code	Dimensions	Remarks
Pitch of component	P	12.7+/-1.0	
Pitch of sprocket hole	P0	12.7+/-0.2	
Lead spacing	F	2.5+0.4/-0.2	
Length from hole center to component center	P2	6.35+/-1.3	Deviation of progress direction
Length from hole center to lead	P1	5.1+/-0.7	
Deviation along tape, left or right defect	ΔS	0+/-2.0	They include deviation by lead bend
Carrier tape width	W	18.0+/-0.5	
Position of sprocket hole	W1	9.0+0/-0.5	Deviation of tape width direction
Lead distance between reference and bottom plane	H	16.0+/-0.5	
Protrusion length	ℓ	0.5 max.	
Diameter of sprocket hole	ΦD0	4.0+/-0.1	
Lead diameter	Φd	0.5+/-0.05	
Total tape thickness	t1	0.6+/-0.3	They include hold down tape thickness
Total thickness of tape and lead wire	t2	1.5 max.	
Deviation across tape	Δh1	1.0 max.	
	Δh2		
Portion to cut in case of defect	L	11.0+0/-1.0	
Hold down tape width	W0	9.5 min.	
Hold down tape position	W2	1.5+/-1.5	
Coating extension on lead	e	1.5 max.	

Inside crimp taping type < Lead Style : M1 >

Pitch of component 12.7mm / Lead spacing 5.0mm



Unit : mm

Item	Code	Dimensions	Remarks
Pitch of component	P	12.7+/-1.0	
Pitch of sprocket hole	P0	12.7+/-0.2	
Lead spacing	F	5.0+0.6/-0.2	
Length from hole center to component center	P2	6.35+/-1.3	Deviation of progress direction
Length from hole center to lead	P1	3.85+/-0.7	
Deviation along tape, left or right defect	ΔS	0+/-2.0	They include deviation by lead bend
Carrier tape width	W	18.0+/-0.5	
Position of sprocket hole	W1	9.0+0/-0.5	Deviation of tape width direction
Lead distance between reference and bottom plane	H0	16.0+/-0.5	
Protrusion length	ℓ	0.5 max.	
Diameter of sprocket hole	ΦD0	4.0+/-0.1	
Lead diameter	Φd	0.5+/-0.05	
Total tape thickness	t1	0.6+/-0.3	They include hold down tape thickness
Total thickness of tape and lead wire	t2	1.5 max.	
Deviation across tape	Δh1	2.0 max. (Dimension code : W)	
	Δh2	1.0 max. (except as above)	
Portion to cut in case of defect	L	11.0+0/-1.0	
Hold down tape width	W0	9.5 min.	
Hold down tape position	W2	1.5+/-1.5	
Coating extension on lead	e	Up to the end of crimp	

7-2. Splicing way of tape

- 1) Adhesive force of tape is over 3N at test condition as below.



2) Splicing of tape

- (a) When base tape is spliced

- Base tape shall be spliced by cellophane tape.
- (Total tape thickness shall be less than 1.05mm.)

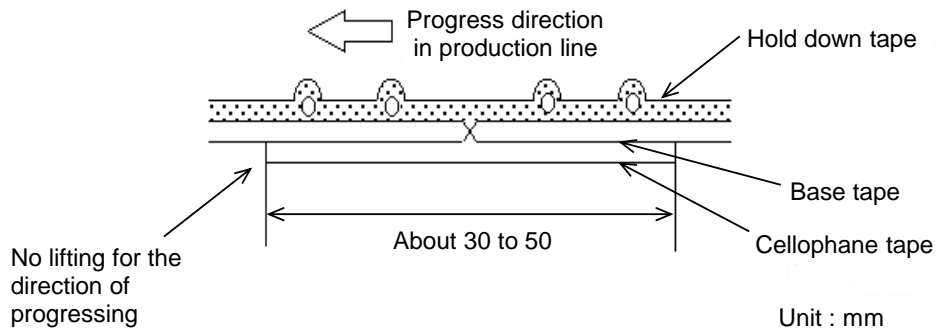

- (b) When hold down tape is spliced

- Hold down tape shall be spliced with overlapping.
- (Total tape thickness shall be less than 1.05mm.)

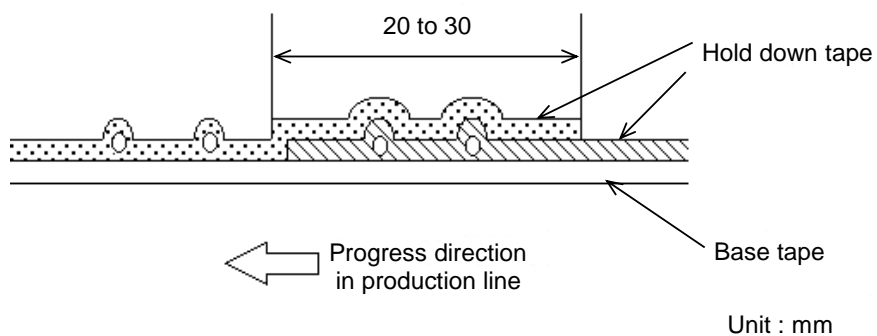

- (c) When both tape are spliced

- Base tape and hold down tape shall be spliced with splicing tape.

3) Missing components

- There should be no consecutive missing of more than three components.
- The number of missing components should be not more than 0.5 % of total components that should be present in a Ammo pack.

⚠ CAUTION**1. OPERATING VOLTAGE**

Do not apply a voltage to the capacitor that exceeds the rated voltage as called out in the specifications.

1-1. Applied voltage between the terminals of a capacitor shall be less than or equal to the rated voltage.

- (1) When AC voltage is superimposed on DC voltage, the zero-to-peak voltage shall not exceed the rated DC voltage. When AC voltage or pulse voltage is applied, the peak-to-peak voltage shall not exceed the rated DC voltage.
- (2) Abnormal voltages (surge voltage, static electricity, pulse voltage, etc.) shall not exceed the rated DC voltage.

Typical Voltage Applied to the DC Capacitor

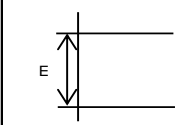
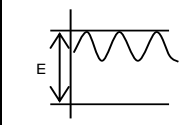
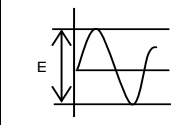
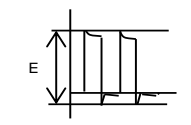
DC Voltage	DC+AC Voltage	AC Voltage	Pulse Voltage
			

(E: Maximum possible applied voltage.)

1-2. Influence of over voltage

Over voltage that is applied to the capacitor may result in an electrical short circuit caused by the breakdown of the internal dielectric layers. The time duration until breakdown depends on the applied voltage and the ambient temperature.

Use a safety standard certified capacitor in a power supply input circuit (AC filter), as it is also necessary to consider the withstand voltage and impulse withstand voltage defined for each device.

2. OPERATING TEMPERATURE AND SELF-GENERATED HEAT

Keep the surface temperature of a capacitor below the upper limit of its rated operating temperature range. Be sure to take into account the heat generated by the capacitor itself.

When the capacitor is used in a high-frequency current, pulse current or the like, it may have the self-generated heat due to dielectric-loss.

In case of Class 2 capacitors (Temp.Char. : X7R,X7S,X8L, etc.), applied voltage should be the load such as self-generated heat is within 20 °C on the condition of atmosphere temperature 25 °C.

Since the self-heating is low in the Class 1 capacitors (Temp.Char.: C0G,U2J,X8G, etc.), the allowable power becomes extremely high compared to the Class 2 capacitors.

However, when a load with self-heating of 20°C is applied at the rated voltage, the allowable power may be exceeded. Please confirm that there is no rising trend of the capacitor's surface temperature and that the surface temperature of the capacitor does not exceed the maximum operating temperature.

Excessive generation of heat may cause deterioration of the characteristics and reliability of the capacitor.

When measuring the self-heating temperature, be aware that accurate measurement may not be possible due to the following effects.

- The heat generated by other parts
- Air flow such as convection and cooling fans
- Temperature sensor used for measuring surface temperature of capacitor

In the case using a thermocouple, it is recommended that use a K thermocouple of $\Phi 0.1\text{mm}$ with less heat capacity.

3. FAIL-SAFE

Capacitors that are cracked by dropping or bending of the board may cause deterioration of the insulation resistance, and result in a short.

If the circuit being used may cause an electrical shock, smoke or fire when a capacitor is shorted, be sure to install fail-safe functions, such as a fuse, to prevent secondary accidents.

4. OPERATING AND STORAGE ENVIRONMENT

The insulating coating of capacitors does not form a perfect seal; therefore, do not use or store capacitors in a corrosive atmosphere, especially where chloride gas, sulfide gas, acid, alkali, salt or the like are present. And avoid exposure to moisture. Before cleaning, bonding, or molding this product, verify that these processes do not affect product quality by testing the performance of a cleaned, bonded or molded product in the intended equipment. Store the capacitors where the temperature and relative humidity do not exceed 5 to 40 °C and 20 to 70%. Use capacitors within 6 months.

Use capacitors within 6 months after delivered. Check the solderability after 6 months or more.

Due to moisture condensation caused by rapid humidity changes, or the photochemical change caused by direct sunlight on the terminal electrodes, the solderability and electrical performance may deteriorate. Do not store capacitors under direct sunlight or in high humidity conditions.

5. VIBRATION AND IMPACT

Do not expose a capacitor or its leads to excessive shock or vibration during use.

5-1. Mechanical shock due to being dropped may cause damage or a crack in the dielectric material of the capacitor.

Do not use a dropped capacitor because the quality and reliability may be deteriorated.

5-2. Excessive shock or vibration may cause to fatigue destruction of lead wires mounted on the circuit board. If necessary, take measures to hold a capacitor on the circuit boards by adhesive, molding resin or coating and other.

Please confirm there is no influence of holding measures on the product with an intended equipment.

6. SOLDERING

When soldering this product to a PCB/PWB, do not exceed the solder heat resistance specification of the capacitor. Subjecting this product to excessive heating could melt the internal junction solder and may result in thermal shocks that can crack the ceramic element.

Please verify that the soldering process does not affect the quality of capacitors.

6-1. Flow Soldering

Soldering temperature	: 260 °C max.
Soldering time	: 7.5 s max.
Preheating temperature	: 120 °C max.
Preheating time	: 60 s max.

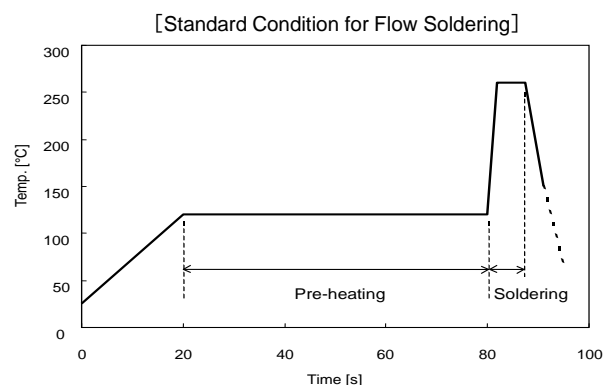

6-2. Reflow Soldering

Do not apply reflow soldering.

6-3. Soldering Iron

Temperature of iron-tip	: 350 °C max.
Soldering iron wattage	: 60 W max.
Soldering time	: 3.5 s max.

7. BONDING AND RESIN MOLDING, RESIN COAT

In case of bonding, molding or coating this product, verify that these processes do not affect the quality of capacitor by testing the performance of a bonded or molded product in the intended equipment.

In case of the amount of applications, dryness / hardening conditions of adhesives and molding resins containing organic solvents (ethyl acetate, methyl ethyl ketone, toluene, etc.) are unsuitable, the outer coating resin of a capacitor is damaged by the organic solvents and it may result, worst case, in a short circuit.

The variation in thickness of adhesive or molding resin may cause a outer coating resin cracking and/or ceramic element cracking of a capacitor in a temperature cycling.

8. TREATMENT AFTER BONDING AND RESIN MOLDING, RESIN COAT

When the outer coating is hot (over 100 °C) after soldering, it becomes soft and fragile.

So please be careful not to give it mechanical stress.

Failure to follow the above cautions may result, worst case, in a short circuit and cause fuming or partial dispersion when the product is used.

9. LIMITATION OF APPLICATIONS

The products listed in the specification(hereinafter the product(s) is called as the "Product(s)") are designed and manufactured for applications specified in the specification. (hereinafter called as the "Specific Application")

We shall not warrant anything in connection with the Products including fitness, performance, adequateness, safety, or quality, in the case of applications listed in from (1) to (11) written at the end of this precautions, which may generally require high performance, function, quality, management of production or safety.

Therefore, the Product shall be applied in compliance with the specific application.

WE DISCLAIM ANY LOSS AND DAMAGES ARISING FROM OR IN CONNECTION WITH THE PRODUCTS INCLUDING BUT NOT LIMITED TO THE CASE SUCH LOSS AND DAMAGES CAUSED BY THE UNEXPECTED ACCIDENT, IN EVENT THAT (i) THE PRODUCT IS APPLIED FOR THE PURPOSE WHICH IS NOT SPECIFIED AS THE SPECIFIC APPLICATION FOR THE PRODUCT, AND/OR (ii) THE PRODUCT IS APPLIED FOR ANY FOLLOWING APPLICATION PURPOSES FROM (1) TO (11) (EXCEPT THAT SUCH APPLICATION PURPOSE IS UNAMBIGUOUSLY SPECIFIED AS SPECIFIC APPLICATION FOR THE PRODUCT IN THE SPECIFICATION.*)

1. Aircraft equipment
2. Aerospace equipment
3. Undersea equipment
4. Power plant control equipment
5. Medical equipment
6. Transportation equipment
7. Traffic control equipment
8. Disaster prevention/security equipment
9. Industrial data-processing equipment
10. Combustion/explosion control equipment
11. Equipment with complexity and/or required reliability equivalent to the applications listed in the above.

For exploring information of the Products which will be compatible with the particular purpose other than those specified in the specification, please contact our sales offices, distribution agents, or trading companies with which you make a deal, or via our web contact form.

Contact form: <https://www.murata.com/contactform>

*We may design and manufacture particular Products for applications listed in (1) to (11). Provided that, in such case we shall unambiguously specify such Specific Application in the specification without any exception.

Therefore, any other documents and/or performances, whether exist or non-exist, shall not be deemed as the evidence to imply that we accept the applications listed in (1) to (11).

NOTICE**1. CLEANING**

- 1-1. Please evaluate the capacitor using actual cleaning equipment and conditions to confirm the quality, and select the solvent for cleaning.
- 1-2. Unsuitable cleaning may leave residual flux or other foreign substances, causing deterioration of electrical characteristics and the reliability of the capacitors.
- 1-3. To perform ultrasonic cleaning, observe the following conditions.
 - Rinse bath capacity : Output of 20 watts per liter or less.
 - Rinsing time : 5 min maximum.
 - Do not vibrate the PCB/PWB directly.
 - Excessive ultrasonic cleaning may lead to fatigue destruction of the lead wires.

2. SOLDERING AND MOUNTING

- 2-1. Insert the lead wire into the PCB with a distance appropriate to the lead space.
If the lead wires are inserted into different spacing holes, cracks may occur in the outer resin or the internal element.
- 2-2. When bending the lead wire, excessive force applied to the capacitor body may cause cracks in the outer resin or the internal element. Hold the lead wire closer to the capacitor body than the lead wire bending position with the fixture, then bend it.

(See the right figure)

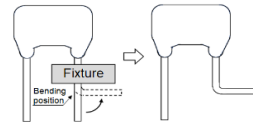

- 2-3. When cutting and clinching the lead wire, do not apply excessive force to the capacitor body.
- 2-4. When soldering, insert the lead wire into the PCB without mechanically stressing the lead wire.

3. CAPACITANCE CHANGE OF CAPACITORS

- Class 2 capacitors (Temp.Char. : X7R,X7S,X8L etc.)
Class 2 capacitors an aging characteristic, whereby the capacitor continually decreases its capacitance slightly if the capacitor leaves for a long time. Moreover, capacitance might change greatly depending on a surrounding temperature or an applied voltage. So, it is not likely to be able to use for the time constant circuit.
Please contact us if you need a detail information.

4. CHARACTERISTICS EVALUATION IN THE ACTUAL SYSTEM

- 4-1. Evaluate the capacitor in the actual system, to confirm that there is no problem with the performance and specification values in a finished product before using.
- 4-2. Since a voltage dependency and temperature dependency exists in the capacitance of Class 2 ceramic capacitors, the capacitance may change depending on the operating conditions in the actual system. Therefore, be sure to evaluate the various characteristics, such as the leakage current and noise absorptivity, which will affect the capacitance value of the capacitor.
- 4-3. In addition, voltages exceeding the predetermined surge may be applied to the capacitor by the inductance in the actual system.
Evaluate the surge resistance in the actual system as required.
- 4-4. When using Class 2 ceramic capacitors in AC or pulse circuits, the capacitor itself vibrates at specific frequencies and noise may be generated. Moreover, when the mechanical vibration or shock is added to capacitor, noise may occur.

⚠ NOTE

1. Please make sure that your product has been evaluated in view of your specifications with our product being mounted to your product.
2. You are requested not to use our product deviating from this product specification.

Looking for pricing, stock, or lifecycle information?

Click below to explore more details on WIN SOURCE:

-  [View RCE5C1H332J0M1H03A on WIN SOURCE](#)
-  [Murata Electronics North America Information](#)

Optimize Your Supply Chain with WIN SOURCE Solutions

-  Global Sourcing Solution
-  Obsolete Management
-  Cost Control Management
-  Shortage Management
-  Alternative Solution
-  Excess Inventory Management