



**THE DATASHEET OF
C566C-AFE-CV0W0342**



Screen Master® 5-mm Oval LEDs: C566C-RFF/RFE/AFF/AFE



PRODUCT DESCRIPTION

These oval LEDs are specifically designed for full-color video screens, digital billboards and passenger-information signs. The oval-shaped radiation pattern and high luminous intensity ensure that these devices are excellent for bright sunlight or low power consumption outdoor applications.

These lamps are made with an advanced optical-grade epoxy that offers superior high-temperature and high-moisture-resistance performance in outdoor signal and sign applications. The encapsulation resin contains anti-UV material in order to reduce the effects of long-term exposure to direct sunlight.

FEATURES

- Size (mm): 5
- Color and Typical Dominant Wavelength:
Red (621nm)
Amber(591nm)
- Luminous Intensity (mcd)
C566C-RFF/RFE: (1520-4180)
C566C-AFF/AFE: (1520-4180)
- Viewing angle:
70 X 35 degree
- Lead - Free
- RoHS Compliant

APPLICATIONS

- Electronic Signs & Signals (ESS)
- Full Color Video Screen
- Digital Billboards
- Motorway Signs
- Variable Message Sign (VMS)
- Advertising Signs
- Petrol Signs

ABSOLUTE MAXIMUM RATINGS ($T_A = 25^\circ\text{C}$)

Items	Symbol	Absolute Maximum Rating	Unit
		Red and Amber	
Forward Current	I_F	50 ^{Note1}	mA
Peak Forward Current ^{Note2}	I_{FP}	200	mA
Reverse Voltage	V_R	5	V
Power Dissipation	P_D	130	mW
Operation Temperature	T_{opr}	-40 ~ +95	$^\circ\text{C}$
Storage Temperature	T_{stg}	-40 ~ +100	$^\circ\text{C}$
Lead Soldering Temperature	T_{sol}	Max. 260 $^\circ\text{C}$ for 3 sec. max. (3 mm from the base of the epoxy bulb)	
Electrostatic Discharge Classification (MIL-STD-883E)	ESD	Class 2	

Note:

- For long term performance the drive currents between 10mA and 30mA are recommended. Please contact Cree LED sales representative for more information on recommended drive conditions.
- Pulse width ≤ 0.1 msec, duty $\leq 1/10$.

TYPICAL ELECTRICAL & OPTICAL CHARACTERISTICS ($T_A = 25^\circ\text{C}$)

Characteristics	Color	Symbol	Condition	Unit	Minimum	Typical	Maximum
Forward Voltage	Red/Amber	V_F	$I_F = 20$ mA	V		2.1	2.6
Reverse Current	Red/Amber	I_R	$V_R = 5$ V	μA			100
Dominant Wavelength	Red	λ_D	$I_F = 20$ mA	nm	619	621	624
	Amber	λ_D	$I_F = 20$ mA	nm	584	591	596
Luminous Intensity	Red	I_V	$I_F = 20$ mA	mcd	1520	2200	
	Amber	I_V	$I_F = 20$ mA	mcd	1520	2200	

- * Continuous reverse voltage can cause LED damage.

INTENSITY BIN LIMIT

Red (20 mA) - C566C-RFF/RFE			Amber (20 mA) - C566C-AFF/AFE		
Bin Code	Min.(mcd)	Max.(mcd)	Bin Code	Min.(mcd)	Max.(mcd)
U0	1520	2130	U0	1520	2130
V0	2130	3000	V0	2130	3000
W0	3000	4180	W0	3000	4180

* Tolerance of measurement of luminous intensity is $\pm 15\%$

COLOR BIN LIMIT

Red (20 mA) - C566C-RFF/RFE			Amber (20 mA) - C566C-AFF/AFE		
Bin Code	Min.(nm)	Max.(nm)	Bin Code	Min.(nm)	Max.(nm)
RB	619	624	A2	584	587
			A3	587	590
			A4	590	593
			A5	593	596

* Tolerance of measurement of dominant wavelength is ± 1 nm.

ORDER CODE TABLE

C566C-RFF/RFE

Color	Kit Number	Luminous Intensity (mcd)		Dominant Wavelength				Package	Standoff
		Min.	Max.	Color Bin	Min. (nm)	Color Bin	Max. (nm)		
Red	C566C-RFF-CU0W0BB1	1520	4180	RB	619	RB	624	Bulk	Yes
Red	C566C-RFF-CU0V0BB1	1520	3000	RB	619	RB	624	Bulk	Yes
Red	C566C-RFF-CV0W0BB1	2130	4180	RB	619	RB	624	Bulk	Yes
Red	C566C-RFE-CU0W0BB1	1520	4180	RB	619	RB	624	Bulk	No
Red	C566C-RFE-CU0V0BB1	1520	3000	RB	619	RB	624	Bulk	No
Red	C566C-RFE-CV0W0BB1	2130	4180	RB	619	RB	624	Bulk	No
Red	C566C-RFF-CU0W0BB2	1520	4180	RB	619	RB	624	Ammo	Yes
Red	C566C-RFF-CU0V0BB2	1520	3000	RB	619	RB	624	Ammo	Yes
Red	C566C-RFF-CV0W0BB2	2130	4180	RB	619	RB	624	Ammo	Yes
Red	C566C-RFE-CU0W0BB2	1520	4180	RB	619	RB	624	Ammo	No
Red	C566C-RFE-CU0V0BB2	1520	3000	RB	619	RB	624	Ammo	No
Red	C566C-RFE-CV0W0BB2	2130	4180	RB	619	RB	624	Ammo	No

C566C-AFF/AFE

Color	Kit Number	Luminous Intensity (mcd)		Dominant Wavelength				Package	Standoff
		Min.	Max.	Color Bin	Min. (nm)	Color Bin	Max. (nm)		
Amber	C566C-AFF-CU0W0251	1520	4180	A2	584	A5	596	Bulk	Yes
Amber	C566C-AFF-CU0V0341	1520	3000	A3	587	A4	593	Bulk	Yes
Amber	C566C-AFF-CV0W0341	2130	4180	A3	587	A4	593	Bulk	Yes
Amber	C566C-AFE-CU0W0251	1520	4180	A2	584	A5	596	Bulk	No
Amber	C566C-AFE-CU0V0341	1520	3000	A3	587	A4	593	Bulk	No
Amber	C566C-AFE-CV0W0341	2130	4180	A3	587	A4	593	Bulk	No
Amber	C566C-AFF-CU0W0252	1520	4180	A2	584	A5	596	Ammo	Yes
Amber	C566C-AFF-CU0V0342	1520	3000	A3	587	A4	593	Ammo	Yes
Amber	C566C-AFF-CV0W0342	2130	4180	A3	587	A4	593	Ammo	Yes
Amber	C566C-AFE-CU0W0252	1520	4180	A2	584	A5	596	Ammo	No
Amber	C566C-AFE-CU0V0342	1520	3000	A3	587	A4	593	Ammo	No
Amber	C566C-AFE-CV0W0342	2130	4180	A3	587	A4	593	Ammo	No

Notes:

- The above kit numbers represent order codes that include multiple intensity-bin and color-bin codes. Only one intensity-bin code and one color-bin code will be shipped on each reel. single intensity-bin, single color-bin codes will not be orderable.
- Please refer to the [HB LED Lamp Reliability Test Standards](#) document for reliability test conditions.
- Please refer to the [HB LED Lamp Soldering & Handling](#) document for information about how to use this LED product safely.

GRAPHS

The data below are collected from statistical figures that do not necessarily correspond to the actual parameters of each single LED. Hence, these data will be changed without further notice.

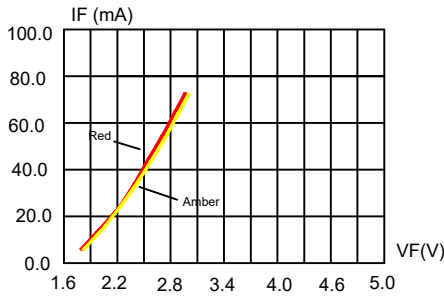

FIG.1 FORWARD CURRENT VS. FORWARD VOLTAGE.

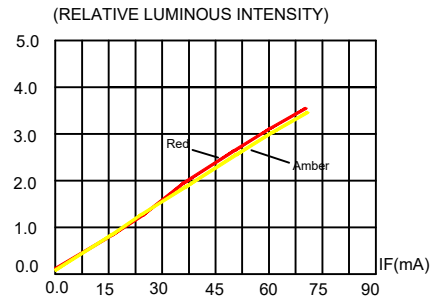

FIG.2 RELATIVE LUMINOUS INTENSITY VS. FORWARD CURRENT

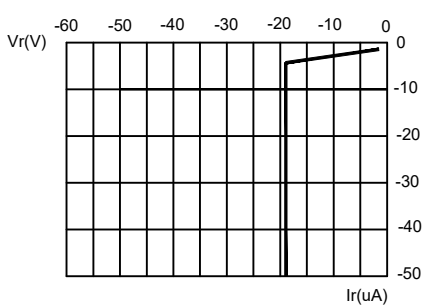

FIG.3a BLUE & GREEN REVERSE CURRENT VS. REVERSE VOLTAGE.

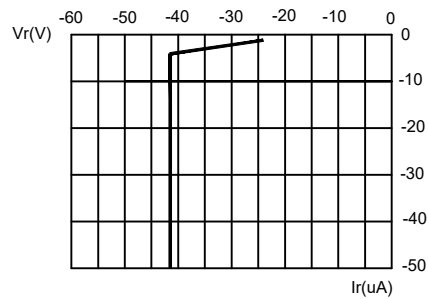

FIG.3b RED & AMBER REVERSE CURRENT VS. REVERSE VOLTAGE.

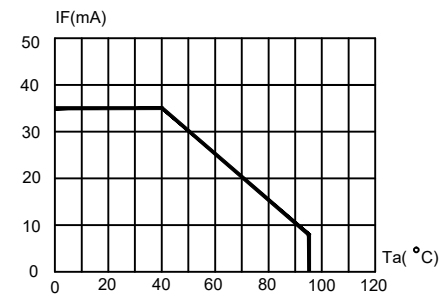

FIG.4a BLUE & GREEN MAXIMUM FORWARD DC CURRENT VS AMBIENT TEMPERATURE (Tjmax=105 C)

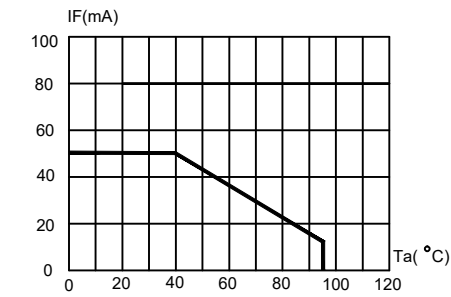

FIG.4b RED & AMBER MAXIMUM FORWARD DC CURRENT VS AMBIENT TEMPERATURE (Tjmax=105 C)

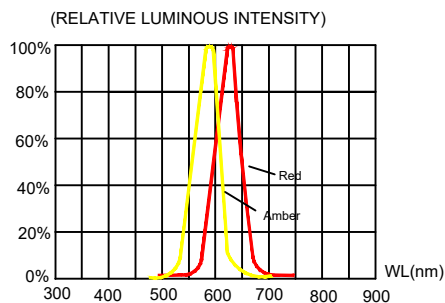

FIG.5 RELATIVE LUMINOUS INTENSITY VS. WAVELENGTH.

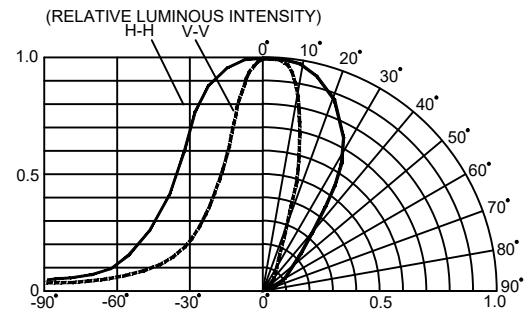

FIG.6 FAR FIELD PATTERN

MECHANICAL DIMENSIONS

All dimensions are in mm. Tolerance is ±0.25 mm unless otherwise noted.

An epoxy meniscus may extend about 1.5 mm down the leads.

Burr around bottom of epoxy may be 0.5 mm max.

C566C-RFF/AFF:

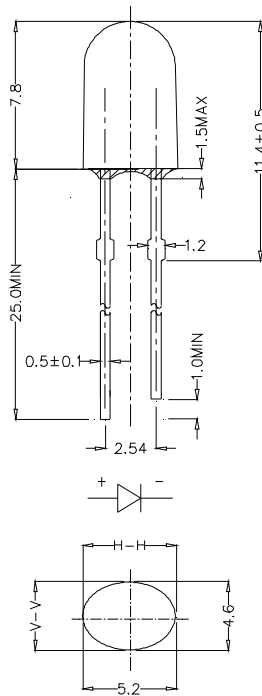

C566C-RFE/AFE:

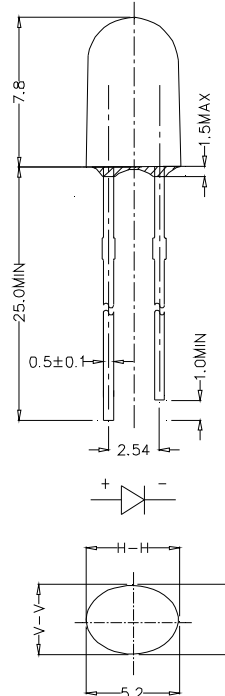

NOTES

Lead Frame Materials

Ag-plated and Lead-free Solder-plated iron.

RoHS Compliance

The levels of RoHS restricted materials in this product are below the maximum concentration values (also referred to as the threshold limits) permitted for such substances, or are used in an exempted application, in accordance with EU Directive 2011/65/EC (RoHS2), as implemented January 2, 2013. RoHS Declarations for this product can be obtained from your Cree LED representative or from the [Product Ecology](#) section of the Cree LED website.

Vision Advisory

WARNING: Do not look at an exposed lamp in operation. Eye injury can result.

KIT NUMBER SYSTEM

Cree LED lamps are tested and sorted into performance bins. A bin is specified by ranges of color, forward voltage, and brightness. Sorted LEDs are packaged for shipping in various convenient options.

Cree LEDs are sold by order codes in combinations of bins called kits. Order codes are configured in the following manner:

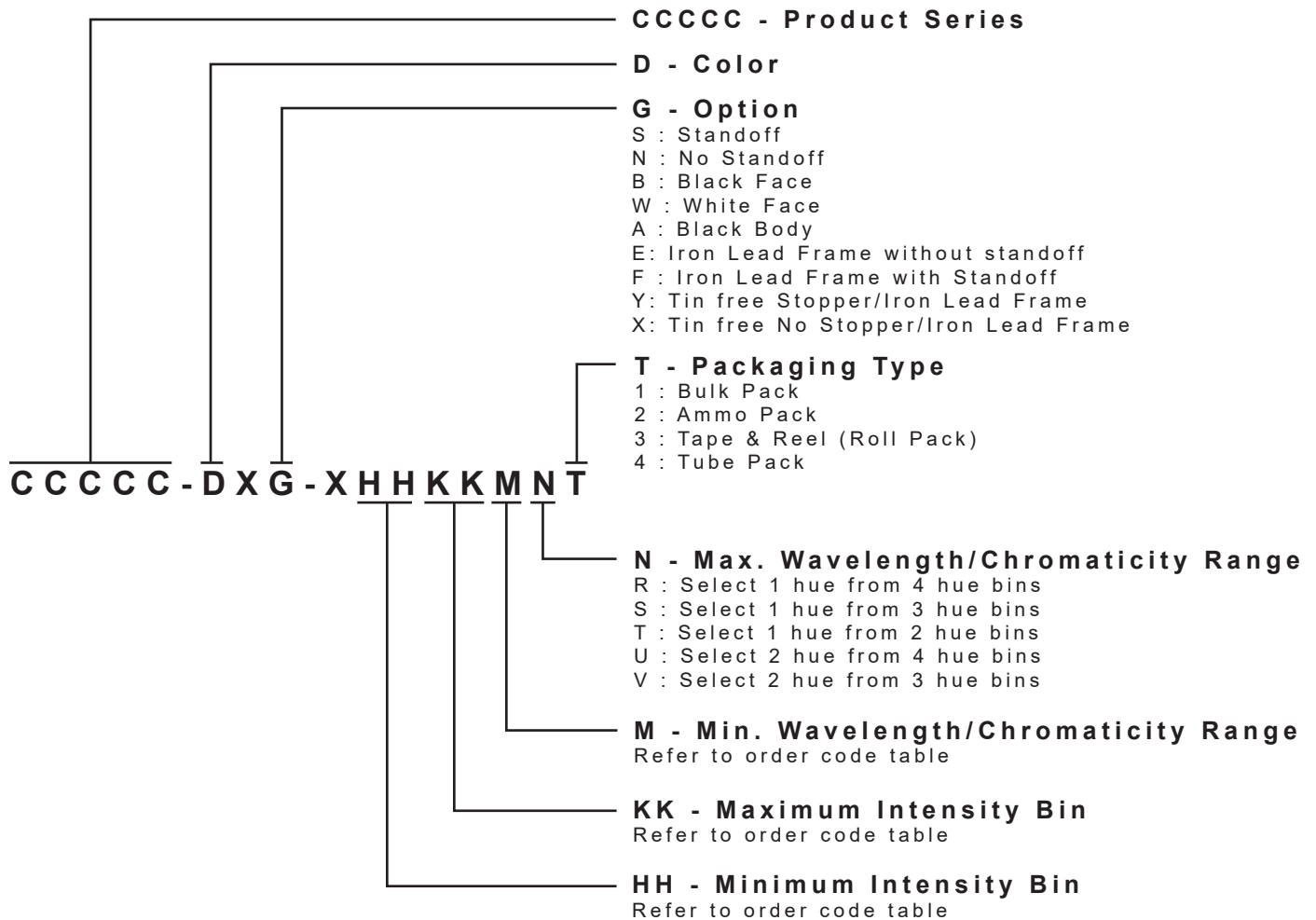

* Please contact our sales representative for ordering information.

SOLDERING GUIDELINES

The LED soldering specification is shown below (suitable for both leaded solder & lead-free solder):

Manual Soldering		Solder Dipping	
Soldering iron	35 W max	Preheat	110 °C max
Temperature	300 °C max	Preheat time	60 seconds max
		Solder-bath temperature	260 °C Max
Soldering time	3 seconds max	Dipping time	5 seconds max
Position	Not less than 3 mm from the base of the package.	Position	Not less than 3 mm from the base of the package.

- Manual soldering onto the PCB is not recommended because soldering time is uncontrollable.
- The recommended wave soldering is as below:

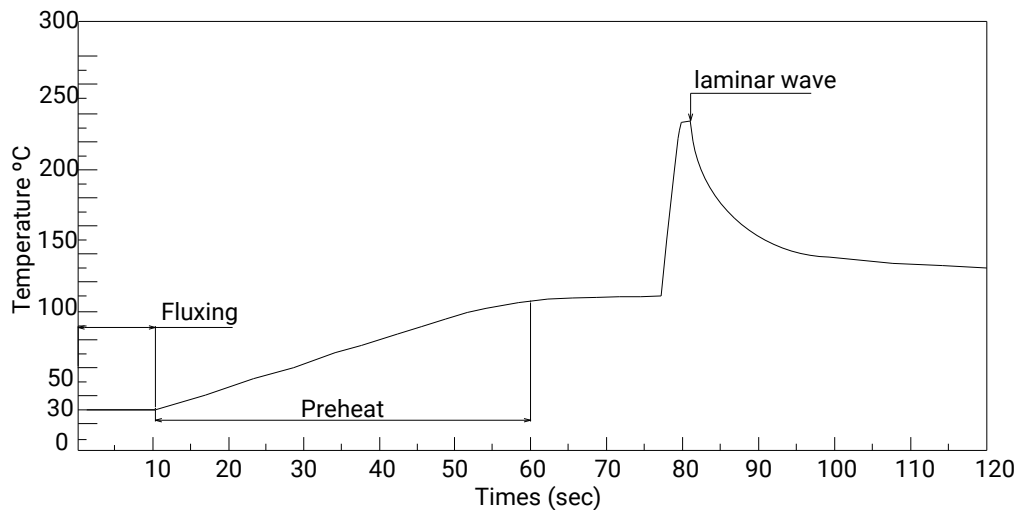

- Do not apply any stress to the LED package, particularly when heated.
- Only bottom preheat is suggested & should not preheat on top in order to reduce thermal stress experienced by the LEDs.
- The LEDs must not be re used once they have been extracted from PCB.
- After soldering the LEDs, the package should be protected from mechanical shock or vibration until the LEDs have reached 40 °C or below.
- Precautions must be taken as mechanical stress on the LEDs may be caused by PCB warpage or from the clinching and cutting of the LED leads.
- When it is necessary to clamp the LEDs during soldering, it is important to ensure no mechanical stress is exerted on the LEDs.
- Cut the LED lead at normal room temperature. Lead cutting at high temperature may cause failure of the LEDs.
- Please refer to the [HB LED Lamp Soldering & Handling](#) document for information about how to use this LED product safely.

PACKAGING

- The LEDs are packed in cardboard boxes after packaging in normal or anti-electrostatic bags.
- Cardboard boxes will be used to protect the LEDs from mechanical shock during transportation.
- The boxes are not water resistant, and they must be kept away from water and moisture.
- Max 500 pcs per bulk and Max 2500 pcs per ammo.

Bulk Pack Packaging Type:

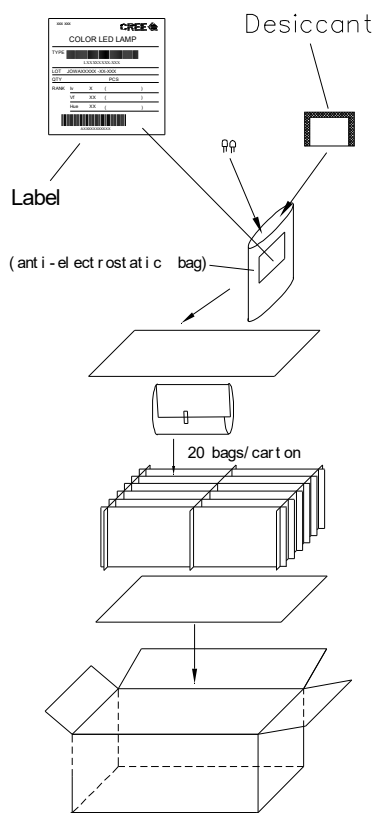

Ammo Pack Packaging Type:

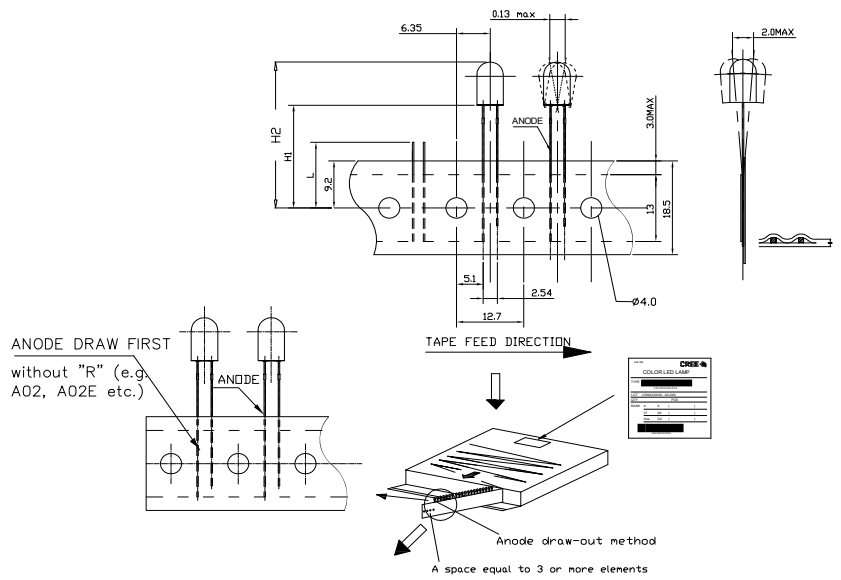

Looking for pricing, stock, or lifecycle information?

Click below to explore more details on WIN SOURCE:

 [View C566C-AFE-CV0W0342 on WIN SOURCE](#)

 [Cree Inc. Information](#)

Optimize Your Supply Chain with WIN SOURCE Solutions

-  Global Sourcing Solution
-  Obsolete Management
-  Cost Control Management
-  Shortage Management
-  Alternative Solution
-  Excess Inventory Management