



**THE DATASHEET OF
RLP2-600-800**



REV.	DESCRIPTION	DATE	APPROVED
A	Engineering Release	11/06/09	T. Y.
B	Added Overall Height "K" Dim	03/04/11	T. Y.
C	Added Overall Snap Height Dimension	08/15/12	T. Y.
D	Added Color Options, Sheet #3	02/02/16	J. C.
E	ECO-1066: Updated Mounting Hole Dimensions	08/11/20	A. V.

REV.	DESCRIPTION	DATE	APPROVED
A	Engineering Release	11/06/09	T. Y.
B	Added Overall Height "K" Dim	03/04/11	T. Y.
C	Added Overall Snap Height Dimension	08/15/12	T. Y.
D	Added Color Options, Sheet #3	02/02/16	J. C.
E	ECO-1066: Updated Mounting Hole Dimensions	08/11/20	A. V.

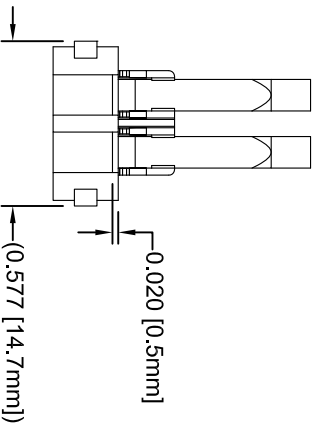
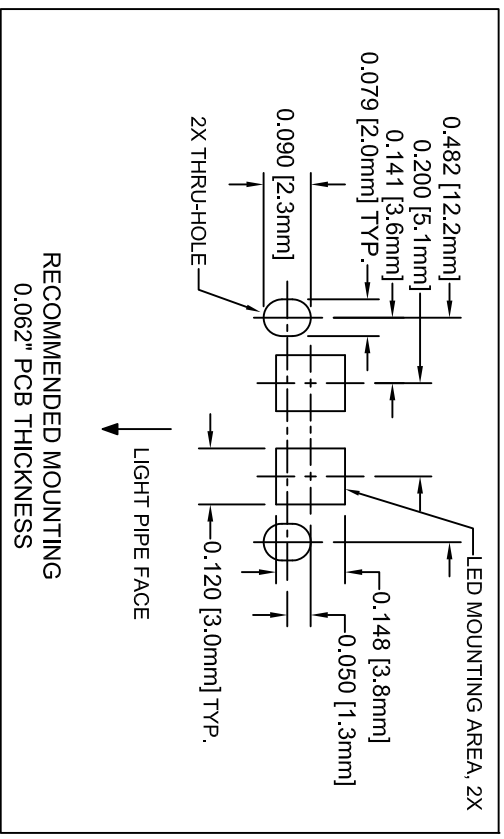
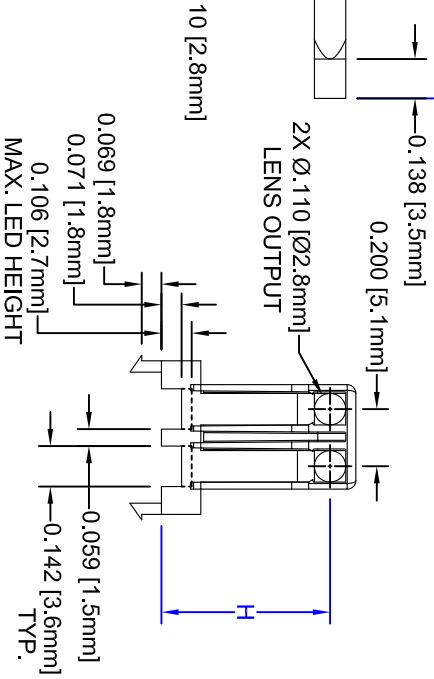
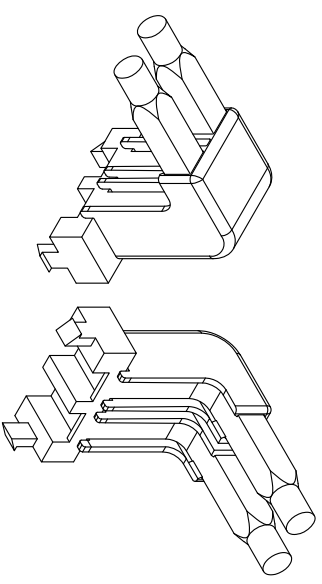
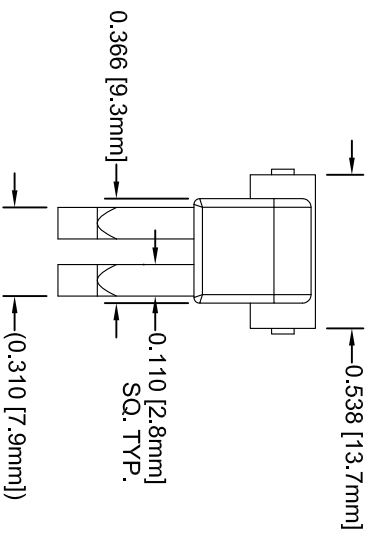

STANDARD TOLERANCE
(UNLESS OTHERWISE SPECIFIED)

DECIMALS
.X ±.1
.XX ±.01
.XXX ±.010

BVVR

4 THOMAS, IRVINE, CA, 92618
TEL: (949) 951-8808 FAX: (949) 951-3974





TITLE: RIGHT ANGLE LIGHT PIPE,
2.8MM, 2 STATION

DESIGNED:	DATE:	PART NO.:	REVISION:
R. Paje	11/06/09	RLP2-XXX-XXX	E
REVISION:	DATE:	SHEET SIZE	CAGE CODE:
K. Baron	08/11/20	A	32559
CHECKED:	DATE:	SCALE:	SHEET # 1 OF 3
A. Valdez	08/11/20	1:1	

CAO GENERATED DOCUMENT, DO NOT MEASURE DRAWING

REV.	DESCRIPTION	DATE	APPROVED
SEE SHEET #1			

RLP2-XXX-XXX

N	H	L	K	LPR2-XXX-XXX	RLPH2-XXX	FIGURE
650	0.197 [5.0mm]	0.551 [14.0mm]	0.287 [7.3mm]	LPR2-200-500	RLPH2-200	
800		0.669 [17.0mm]		LPR2-200-800	RLPH2-200	
500	0.394 [10.0mm]	0.551 [14.0mm]	0.484 [12.3mm]	LPR2-400-500	RLPH2-400	
650		0.669 [17.0mm]		LPR2-400-650	RLPH2-400	
800		0.787 [20.0mm]		LPR2-400-800	RPH2-400	
500	0.591 [15.0mm]	0.551 [14.0mm]	0.681 [17.3mm]	LPR2-600-500	RLPH2-600	
650		0.669 [17.0mm]		LPR2-600-650	RLPH2-600	
800		0.787 [20.0mm]		LPR2-600-800	RLPH2-600	

CAGE CODE:	32559	PART NO.:	RLP2-XXX-XXX	REVISION:	E
SHEET SIZE:	A	SCALE:	1:1	SHEET #	2 OF 3
CAD GENERATED DOCUMENT. DO NOT MEASURE DRAWING.					



RRS
INFORMATION

REV.	DESCRIPTION	DATE	APPROVED
	SEE SHEET #1		

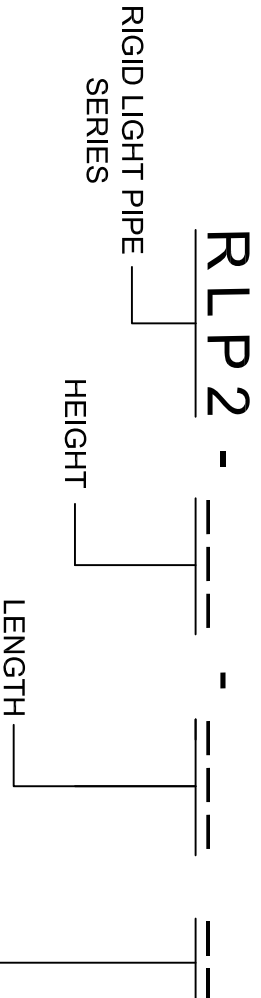

RLP2

COLOR	Order Code
BLUE	BE
BLACK	BK
GREEN	GN
GRAY	GY
RED	RD
YELLOW	YW

NOTE: LEAVE ORDER CODE BLANK
 IF NO COLOR IS DESIRED.



EMBLIES WILL BE DYED.
 OR UPON REQUEST.

CAGE CODE:	32559
SHEET SIZE:	A

BVVR		PART NO:	RLP2-XXX-XXX	REVISION:	E
		SCALE:	1:1	SHEET #	3 OF 3
CAD GENERATED DOCUMENT. DO NOT MEASURE DRAWING.					

Looking for pricing, stock, or lifecycle information?

Click below to explore more details on WIN SOURCE:

-  [View RLP2-600-800 on WIN SOURCE](#)
-  [Bivar Inc. Information](#)

Optimize Your Supply Chain with WIN SOURCE Solutions

-  Global Sourcing Solution
-  Obsolete Management
-  Cost Control Management
-  Shortage Management
-  Alternative Solution
-  Excess Inventory Management