



**THE DATASHEET OF**  
**1101**





## "18350" LITHIUM-ION BATTERY HOLDERS

THM Leaf Springs

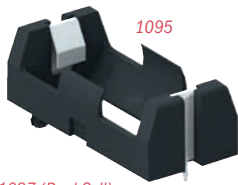

1095  
1097 (Dual Cell)  
Not Shown

THM Polarized



1095P  
1097P (Dual Cell)  
Not Shown

Solder Lugs\*



1101  
1102 (Dual Cell)  
Not Shown

SMT Leaf Springs



1096  
1098 (Dual Cell)  
Not Shown

SMT Polarized



1096P  
1098P (Dual Cell)  
Not Shown

### FEATURES

- Low profile surface mount holder for Cylindrical Lithium and alkaline batteries
- UL 94V-0 heat resistant nylon housing well suited for reflow soldering
- Battery installation and removal does not require tools
- Securely holds battery in place

- Accommodates cells with or without built-in PCB protection circuits
- Polarity clearly marked for orientation
- Polarized holders available for protection against improper battery installation

**Operating Temp Range:**  
-60°F to +290°F (-50°C to +145°C)

### APPLICATIONS

- Computer memory, power backup systems
- Digital readers
- Laptop and touch pad computers
- PLC and industrial controls
- Electronic cigarette/vapor industry



PC Battery Clip  
Available  
See Page 11.

### THRU HOLE MOUNT

### SURFACE MOUNT

#### SINGLE CELL

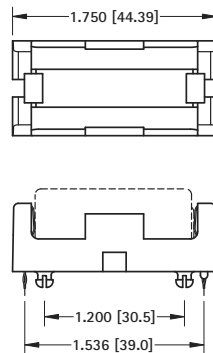
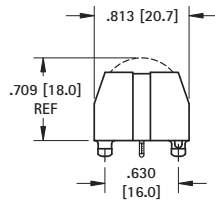

#### Mounting Detail

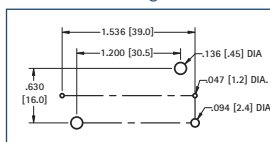

### SPECIFICATIONS

**Base:** High Temp Nylon 46, UL 94V-0  
**Contacts:** .012 (.30) Stainless Steel, Tin-Nickel Plate

**CAT. NO. 1095** Leaf Springs

**CAT. NO. 1095P** Polarized Holder

**CAT. NO. 1101** Solder Lugs \*see image above

**Packaging Spec's:** 50 pieces per tray

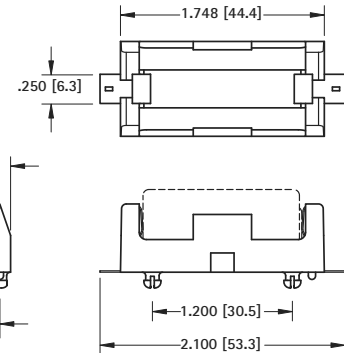
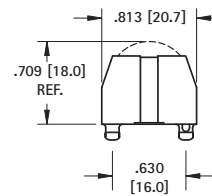

#### Pad Layout

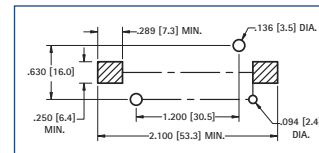

### SPECIFICATIONS

**Base:** High Temp Nylon 46, UL 94V-0  
**Contacts:** .012 (.30) Stainless Steel, Gold Plate (Flash)

**CAT. NO. 1096** Leaf Springs

**CAT. NO. 1096P** Polarized Holder

**Packaging Spec's:** 50 pieces per tray

#### DUAL CELL

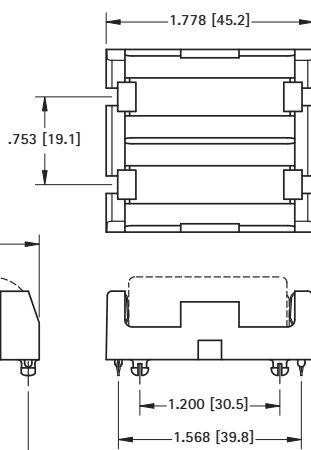
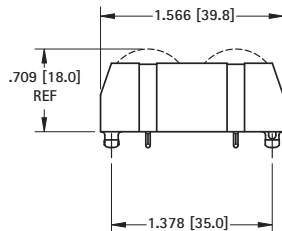
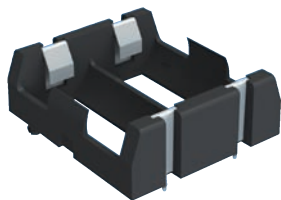

#### Mounting Detail

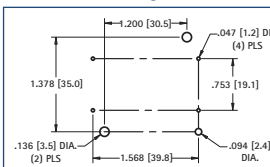

### SPECIFICATIONS

**Base:** High Temp Nylon 46, UL 94V-0  
**Contacts:** .012 (.30) Stainless Steel, Tin-Nickel Plate

**CAT. NO. 1097** Leaf Springs

**CAT. NO. 1097P** Polarized Holder

**CAT. NO. 1102** Solder Lugs \*see image above

**Packaging Spec's:** 25 pieces per tray

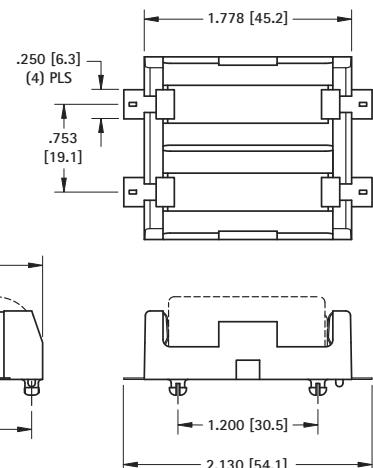
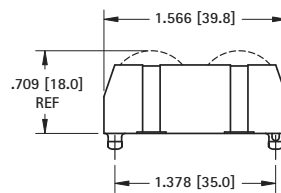
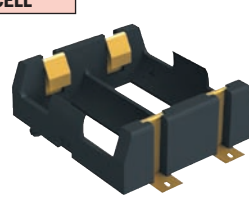

#### Pad Layout

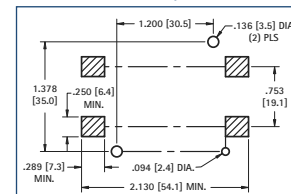

### SPECIFICATIONS

**Base:** High Temp Nylon 46, UL 94V-0  
**Contacts:** .012 (.30) Stainless Steel, Gold Plate (Flash)

**CAT. NO. 1098** Leaf Springs

**CAT. NO. 1098P** Polarized Holder



**Packaging Spec's:** 25 pieces per tray

"18350" LITHIUM-ION BATTERY HOLDERS



## Looking for pricing, stock, or lifecycle information?

Click below to explore more details on WIN SOURCE:

-  [View 1101 on WIN SOURCE](#)
-  [Keystone Electronics Information](#)

## Optimize Your Supply Chain with WIN SOURCE Solutions

-  Global Sourcing Solution
-  Obsolete Management
-  Cost Control Management
-  Shortage Management
-  Alternative Solution
-  Excess Inventory Management