



THE DATASHEET OF
4400.0593



Circuit Breaker for Equipment thermal, Drop-in type, Reset type, Quick connect terminals



See below:

Approvals and Compliances

Description

- Drop-in type
- Thermal circuit breaker
- 1-pole
- Reset type
- Quick connect terminals 6.3 x 0.8 mm

Unique Selling Proposition

- Compact design
- Positively trip-free release
- Available with cover
- Different mounting possibilities

Applications

- Power tools
- Household Equipment
- Power supplies and chargers
- Industrial appliances

Weblinks

[pdf data sheet](#), [html datasheet](#), [General Product Information](#), [Distributor-Stock-Check](#), [Detailed request for product](#), [Product News](#)

Technical Data

| | |
|--|--|
| Rated Voltage AC | AC 240 VAC |
| Rated Voltage DC | 48 VDC |
| Rated current range AC | 0.05 - 16 A |
| Conditional short circuit capacity I _{nc} | IEC 60934: PC1, AC 240 V: 2 kA |
| Short circuit capacity I _{cn} | IEC 60934: at I _n < 6.5 A/240 VAC : 8 x I _n IEC 60934: at I _n ≥ 6.5 A/240 VAC : 96 A |
| Degree of Protection | front side IP40 acc. to IEC 60529 |
| Dielectric Strength | 50Hz: > 1.5kV Impulse 1.2/50 μs: > 2.5kV |
| Insulation Resistance | 500VDC > 100 MΩ |
| Endurance typical | 2 x I _r : 500 switching cycles |
| Endurance minimum | Reset type AC : 2 x I _r , cos φ 0.6 : DC : 2 x I _r , L/R = 2 - 3 ms : 50 switching cycles |

| | |
|---------------------------|--|
| Overload | IEC: min. 40 trips @ 6 x I _r , cos φ 0.6 UL / CSA: min. 50 trips @ 1.5 x I _r , cos φ 0.75 |
| Allowable Operation Temp. | -5 °C to 60 °C |
| Vibration Resistance | ± 1.5 mm @ 10 - 60 Hz acc. to IEC 60068-2-6, test Fc 5 G @ 60 - 500 Hz acc. to IEC 60068-2-6, test Fc |
| Shock Resistance | 100 G / 6ms acc. to IEC 60068-2-27, test Ea |
| Tripping Type | Thermal |
| Actuation Type | Reset type |
| Weight | ca. 10g |

Approvals and Compliances



Detailed information on product approvals, code requirements, usage instructions and detailed test conditions can be looked up in [Details about Approvals](#)

SCHURTER products are designed for use in industrial environments. They have approvals from independent testing bodies according to national and international standards. Products with specific characteristics and requirements such as required in the automotive sector according to IATF 16949, medical technology according to ISO 13485 or in the aerospace industry can be offered exclusively with customer-specific, individual agreements by SCHURTER.

Approvals

The approval mark is used by the testing authorities to certify compliance with the safety requirements placed on electronic products.

Approval Reference Type: T11

| Approval Logo | Certificates | Certification Body | Description |
|--|-------------------------------|--------------------|--|
|  | VDE Approvals | VDE | VDE Certificate Number: 99759 |
|  | UL Approvals | UL | UR File Number: E71572 |
|  | CCC Approvals | CCC | CCC Certificate Number: 2024010307710413 |

Product standards

Product standards that are referenced

| Organization | Design | Standard | Description |
|--|-----------------------|-------------------|---|
|  | Designed according to | IEC 60934 | Circuit-breakers for equipment (CBE) |
|  | Designed according to | UL 1077 | Standard for Supplementary Protectors for Use in Electrical Equipment |
|  | Designed according to | CSA C22.2 No. 235 | Supplementary Protectors |
|  | Designed according to | GB 17701 | Circuit-breaker for equipment |





Application standards

Application standards where the product can be used

| Organization | Design | Standard | Description |
|---|--------------------------------|----------------|---|
|  | Suitable for applications acc. | IEC/UL 62368-1 | Audio/video, information and communication technology equipment - Part 1: Safety requirements |

Compliances

The product complies with following Guide Lines

| Identification | Details | Initiator | Description |
|--|--|-------------|---|
|  | CE declaration of conformity | SCHURTER AG | The CE marking declares that the product complies with the applicable requirements laid down in the harmonisation of Community legislation on its affixing in accordance with EU Regulation 765/2008. |
|  | UKCA declaration of conformity | SCHURTER AG | The UKCA marking declares that the product complies with the applicable requirements laid down in the British Amendment of Regulation (EC) 765/2008. |
|  | RoHS | SCHURTER AG | Directive RoHS 2011/65/EU, Amendment (EU) 2015/863 |
|  | China RoHS | SCHURTER AG | The law SJ / T 11363-2006 (China RoHS) has been in force since 1 March 2007. It is similar to the EU directive RoHS. |
|  | REACH | SCHURTER AG | On 1 June 2007, Regulation (EC) No 1907/2006 on the Registration, Evaluation, Authorization and Restriction of Chemicals 1 (abbreviated as "REACH") entered into force. |

Dimension [mm]

T11-811 $\leq 7,5A$

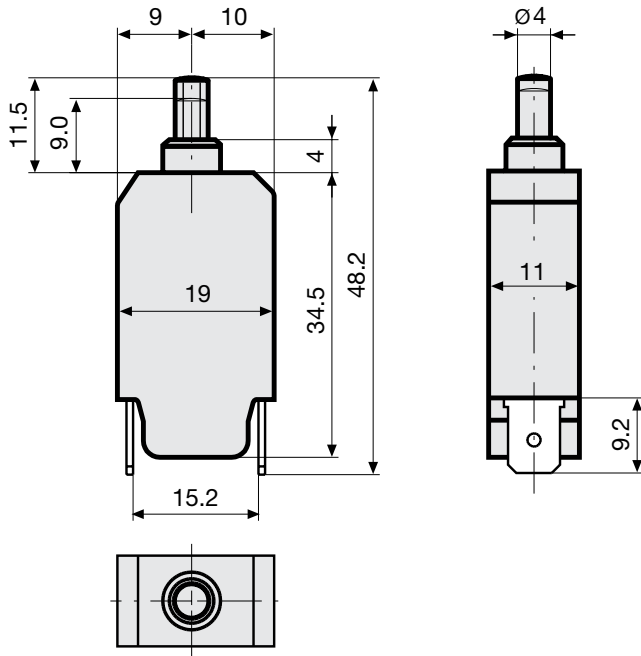

T11-811 $> 7,5 A$

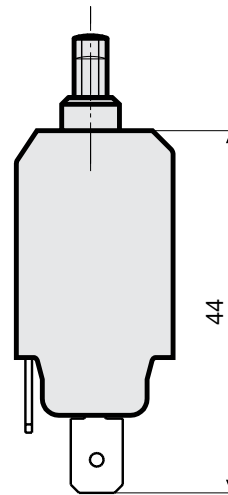

T11-811N

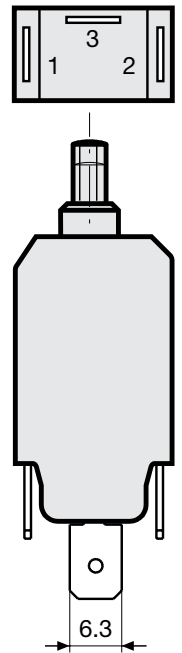

Diagrams

Rated current $\leq 7,5 A$

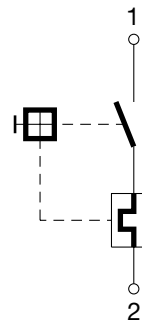

Rated current $> 7,5 A$

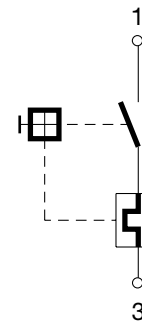

Shunt terminal T11-...N $\leq 6,5 A$

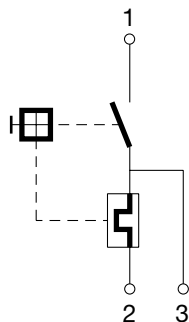

Typical internal resistance per pole

| Rated Current [A] | Internal Resistance [Ω] |
|-------------------|----------------------------------|
| 0.05 | 380.000 |
| 0.50 | 5.200 |
| 1.00 | 1.350 |
| 2.00 | 0.300 |
| 3.00 | 0.130 |
| 4.00 | 0.080 |
| 5.00 | 0.040 |
| 6.00 | 0.040 |
| 7.00 | 0.020 |
| 8.00 | 0.012 |
| 9.00 | 0.012 |
| 10.00 | 0.011 |
| 11.00 | 0.0095 |
| 12.00 | 0.0095 |
| 13.00 | 0.0085 |
| 14.00 | 0.0085 |
| 15.00 | 0.0075 |
| 16.00 | 0.0075 |

Effect of ambient temperature

The units are calibrated for an ambient temperature of +23°C. To determine the rated current for a lower or higher ambient temperature, use a correction factor (typical value) from the table below:

| Ambient Temperature [°C] | Correction factor |
|--------------------------|-------------------|
| -5 | 0.87 |
| 0 | 0.90 |
| +10 | 0.95 |
| +23 | 1.00 |
| +30 | 1.04 |
| +40 | 1.10 |
| +50 | 1.15 |
| +60 | 1.20 |

Example: Rated current = 5 A, Environmental temperature = 40 °C, --> Correction factor = 1.1, Resulting current = 5.5 A --> Round to next higher rated current: 6 A

Time-Current-Curves

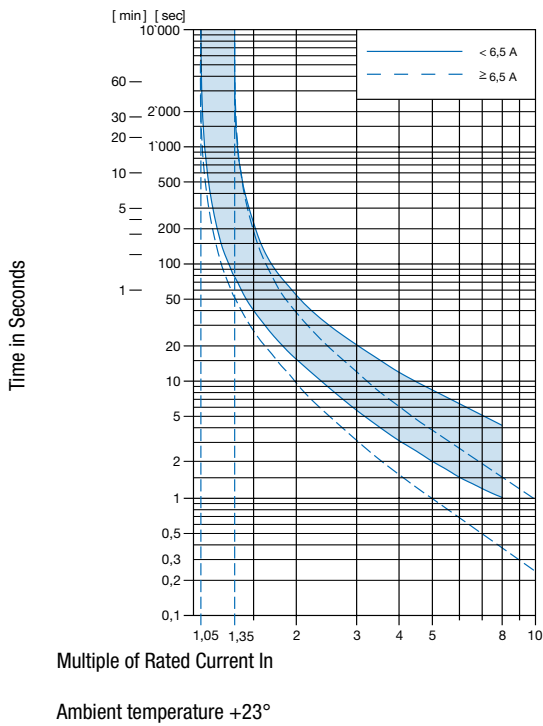

Config. Code

T11 - 1 2 3 A B - 1.23

The characters are placeholders for the correspondingly keys of selections from the key tables.

T11 - **1** 2 3 A B - 1.23 = Mounting

| Mounting | Configuration key |
|--------------|-------------------|
| Drop-in type | 8 |

T11 - 1 **2** 3 A B - 1.23 = Actuation Type

| Actuation Type | Configuration key |
|----------------|-------------------|
| Reset type | 1 |

T11 - 1 2 **3** A B - 1.23 = Terminal

| Terminal | Configuration key |
|----------------------------------|-------------------|
| Quick connect terminal 6.3x0.8mm | 1 |

T11 - 1 2 3 **A** B - 1.23 = Shunt terminal

| Shunt terminal | Configuration key |
|----------------|-------------------|
| Shunt terminal | N |

T11 - 1 2 3 A **B** - 1.23 = Setting indication

| Setting indication | Configuration key |
|--------------------|-------------------|
| Setting indication | R |

T11 - 1 2 3 A B - **1.23** = Rated current

| Rated current | Configuration key |
|---------------|-------------------|
| | |

Other rated currents on request

Variants

| Rated current | Construction variants | | Config. Code | Order Number |
|---------------|-----------------------|--------------------|--------------|--------------|
| | Shunt terminal | Setting indication | | |
| 2.5 A | - | - | - | 4400.0178 |
| 3.0 A | - | - | - | 4400.0112 |
| 5.0 A | - | - | - | 4400.0114 |
| 5.5 A | - | - | - | 4400.0120 |
| 6.0 | - | - | - | 4400.0179 |

| Rated current | Construction variants | | Config. Code | Order Number |
|---------------|-----------------------|--------------------|--------------|--------------|
| | Shunt terminal | Setting indication | | |

Availability for all products can be searched real-time: <https://www.schurter.com/en/info-center/support-tools/stock-check-distributors>

| | |
|-----------------------|---------|
| Packaging Unit | 100 Pcs |
|-----------------------|---------|

Looking for pricing, stock, or lifecycle information?

Click below to explore more details on WIN SOURCE:

 [View 4400.0593 on WIN SOURCE](#)

 [Schurter Inc. Information](#)

Optimize Your Supply Chain with WIN SOURCE Solutions

-  Global Sourcing Solution
-  Obsolete Management
-  Cost Control Management
-  Shortage Management
-  Alternative Solution
-  Excess Inventory Management