



**THE DATASHEET OF
IDT71V3576S150PF**





128K x 36, 256K x 18
3.3V Synchronous SRAMs
3.3V I/O, Pipelined Outputs
Burst Counter, Single Cycle Deselect

IDT71V3576S
IDT71V3578S

Features

- ◆ 128K x 36, 256K x 18 memory configurations
- ◆ Supports high system speed:
Commercial and Industrial:
 - 150MHz 3.8ns clock access time
 - 133MHz 4.2ns clock access time
- ◆ $\overline{\text{LBO}}$ input selects interleaved or linear burst mode
- ◆ Self-timed write cycle with global write control ($\overline{\text{GW}}$), byte write enable ($\overline{\text{BWE}}$), and byte writes ($\overline{\text{BWx}}$)
- ◆ 3.3V core power supply
- ◆ Power down controlled by ZZ input
- ◆ 3.3V I/O
- ◆ Packaged in a JEDEC Standard 100-pin plastic thin quad flatpack (TQFP)

Description

The IDT71V3576/78 are high-speed SRAMs organized as 128K x 36/256K x 18. The IDT71V3576/78 SRAMs contain write, data, address and control registers. Internal logic allows the SRAM to generate a self-timed write based upon a decision which can be left until the end of the write cycle.

The burst mode feature offers the highest level of performance to the system designer, as the IDT71V3576/78 can provide four cycles of data for a single address presented to the SRAM. An internal burst address counter accepts the first cycle address from the processor, initiating the access sequence. The first cycle of output data will be pipelined for one cycle before it is available on the next rising clock edge. If burst mode operation is selected ($\overline{\text{ADV}}=\text{LOW}$), the subsequent three cycles of output data will be available to the user on the next three rising clock edges. The order of these three addresses are defined by the internal burst counter and the $\overline{\text{LBO}}$ input pin.

The IDT71V3576/78 SRAMs utilize the latest high-performance CMOS process and are packaged in a JEDEC standard 14mm x 20mm 100-pin thin plastic quad flatpack (TQFP).

Pin Description Summary

A0-A17	Address Inputs	Input	Synchronous
$\overline{\text{CE}}$	Chip Enable	Input	Synchronous
CS0, $\overline{\text{CS}}_1$	Chip Selects	Input	Synchronous
$\overline{\text{OE}}$	Output Enable	Input	Asynchronous
$\overline{\text{GW}}$	Global Write Enable	Input	Synchronous
$\overline{\text{BWE}}$	Byte Write Enable	Input	Synchronous
$\overline{\text{BW}}_1, \overline{\text{BW}}_2, \overline{\text{BW}}_3, \overline{\text{BW}}_4^{(1)}$	Individual Byte Write Selects	Input	Synchronous
CLK	Clock	Input	N/A
$\overline{\text{ADV}}$	Burst Address Advance	Input	Synchronous
$\overline{\text{ADSC}}$	Address Status (Cache Controller)	Input	Synchronous
$\overline{\text{ADSP}}$	Address Status (Processor)	Input	Synchronous
$\overline{\text{LBO}}$	Linear / Interleaved Burst Order	Input	DC
ZZ	Sleep Mode	Input	Asynchronous
I/O0-I/O31, I/OP1-I/OP4	Data Input / Output	I/O	Synchronous
VDD, VDDQ	Core Power, I/O Power	Supply	N/A
VSS	Ground	Supply	N/A

5279 tbl 01

NOTE:

1. $\overline{\text{BW}}_3$ and $\overline{\text{BW}}_4$ are not applicable for the IDT71V3578.

Pin Definitions⁽¹⁾

Symbol	Pin Function	I/O	Active	Description
A0-A17	Address Inputs	I	N/A	Synchronous Address inputs. The address register is triggered by a combination of the rising edge of CLK and $\overline{\text{ADSC}}$ Low or $\overline{\text{ADSP}}$ Low and $\overline{\text{CE}}$ Low.
$\overline{\text{ADSC}}$	Address Status (Cache Controller)	I	LOW	Synchronous Address Status from Cache Controller. $\overline{\text{ADSC}}$ is an active LOW input that is used to load the address registers with new addresses.
$\overline{\text{ADSP}}$	Address Status (Processor)	I	LOW	Synchronous Address Status from Processor. $\overline{\text{ADSP}}$ is an active LOW input that is used to load the address registers with new addresses. $\overline{\text{ADSP}}$ is gated by $\overline{\text{CE}}$.
$\overline{\text{ADV}}$	Burst Address Advance	I	LOW	Synchronous Address Advance. $\overline{\text{ADV}}$ is an active LOW input that is used to advance the internal burst counter, controlling burst access after the initial address is loaded. When the input is HIGH the burst counter is not incremented; that is, there is no address advance.
$\overline{\text{BWE}}$	Byte Write Enable	I	LOW	Synchronous byte write enable gates the byte write inputs $\overline{\text{BW1}}\text{-}\overline{\text{BW4}}$. If $\overline{\text{BWE}}$ is LOW at the rising edge of CLK then $\overline{\text{BWx}}$ inputs are passed to the next stage in the circuit. If $\overline{\text{BWE}}$ is HIGH then the byte write inputs are blocked and only $\overline{\text{GW}}$ can initiate a write cycle.
$\overline{\text{BW1}}\text{-}\overline{\text{BW4}}$	Individual Byte Write Enables	I	LOW	Synchronous byte write enables. $\overline{\text{BW1}}$ controls I/O0-7, I/OP1, $\overline{\text{BW2}}$ controls I/O8-15, I/OP2, etc. Any active byte write causes all outputs to be disabled.
$\overline{\text{CE}}$	Chip Enable	I	LOW	Synchronous chip enable. $\overline{\text{CE}}$ is used with $\overline{\text{CS0}}$ and $\overline{\text{CS1}}$ to enable the IDT71V3576/78. $\overline{\text{CE}}$ also gates $\overline{\text{ADSP}}$.
CLK	Clock	I	N/A	This is the clock input. All timing references for the device are made with respect to this input.
$\overline{\text{CS0}}$	Chip Select 0	I	HIGH	Synchronous active HIGH chip select. $\overline{\text{CS0}}$ is used with $\overline{\text{CE}}$ and $\overline{\text{CS1}}$ to enable the chip.
$\overline{\text{CS1}}$	Chip Select 1	I	LOW	Synchronous active LOW chip select. $\overline{\text{CS1}}$ is used with $\overline{\text{CE}}$ and $\overline{\text{CS0}}$ to enable the chip.
$\overline{\text{GW}}$	Global Write Enable	I	LOW	Synchronous global write enable. This input will write all four 9-bit data bytes when LOW on the rising edge of CLK. $\overline{\text{GW}}$ supersedes individual byte write enables.
I/O0-I/O31 I/OP1-I/OP4	Data Input/Output	I/O	N/A	Synchronous data input/output (I/O) pins. Both the data input path and data output path are registered and triggered by the rising edge of CLK.
$\overline{\text{LBO}}$	Linear Burst Order	I	LOW	Asynchronous burst order selection input. When $\overline{\text{LBO}}$ is HIGH, the interleaved burst sequence is selected. When $\overline{\text{LBO}}$ is LOW the Linear burst sequence is selected. $\overline{\text{LBO}}$ is a static input and must not change state while the device is operating.
$\overline{\text{OE}}$	Output Enable	I	LOW	Asynchronous output enable. When $\overline{\text{OE}}$ is LOW the data output drivers are enabled on the I/O pins if the chip is also selected. When $\overline{\text{OE}}$ is HIGH the I/O pins are in a high-impedance state.
ZZ	Sleep Mode	I	HIGH	Asynchronous sleep mode input. ZZ HIGH will gate the CLK internally and power down the IDT71V3576/78 to its lowest power consumption level. Data retention is guaranteed in Sleep Mode. This pin has an internal pull down.
VDD	Power Supply	N/A	N/A	3.3V core power supply.
VDDQ	Power Supply	N/A	N/A	3.3V I/O Supply.
VSS	Ground	N/A	N/A	Ground.
NC	No Connect	N/A	N/A	NC pins are not electrically connected to the device.

5279 tbl 02

NOTE:

1. All synchronous inputs must meet specified setup and hold times with respect to CLK.

Functional Block Diagram

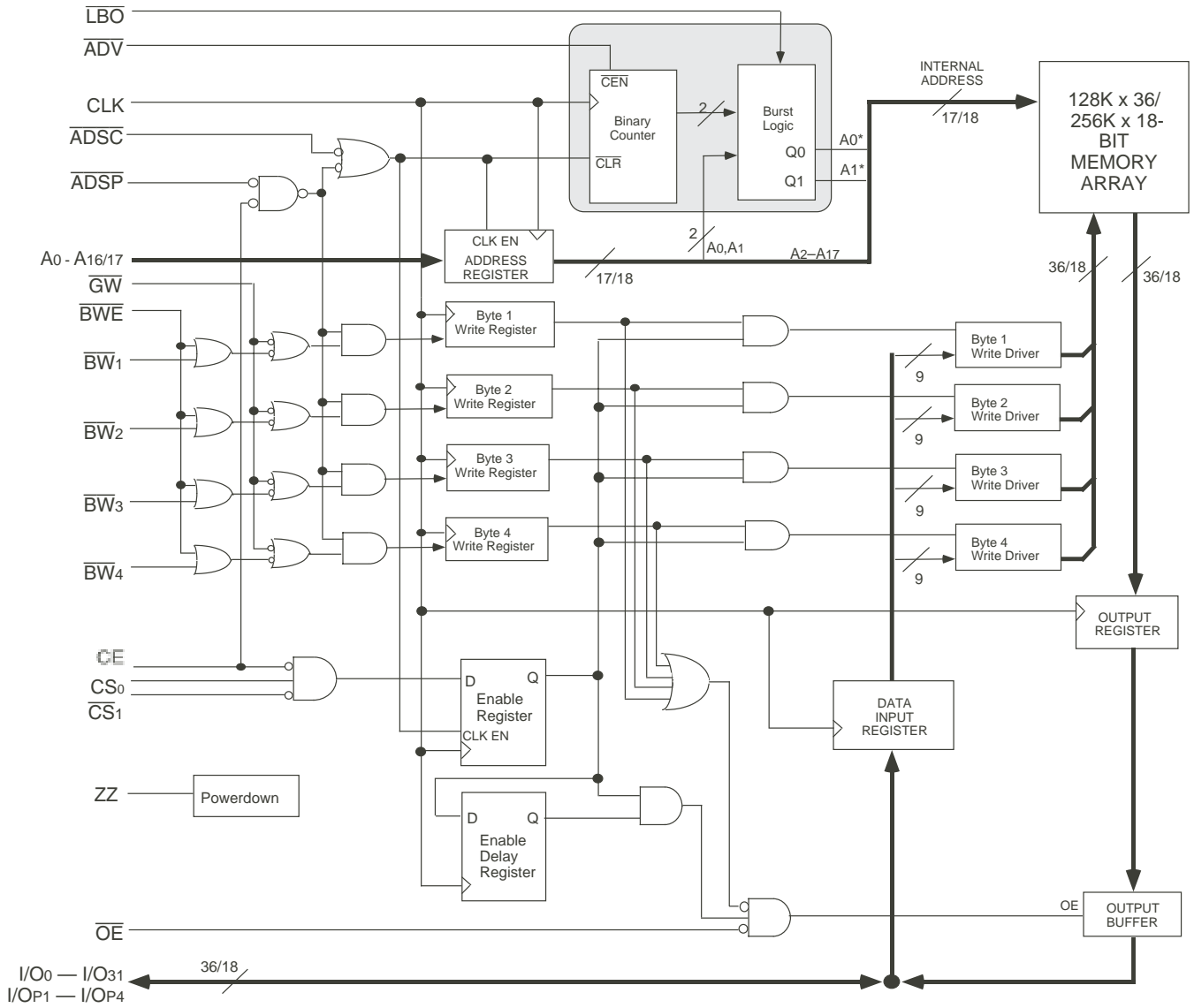

5279 drw 01

Absolute Maximum Ratings⁽¹⁾

Symbol	Rating	Commercial & Industrial	Unit
V _{TERM} ⁽²⁾	Terminal Voltage with Respect to GND	-0.5 to +4.6	V
V _{TERM} ^(3,6)	Terminal Voltage with Respect to GND	-0.5 to V _{DD}	V
V _{TERM} ^(4,6)	Terminal Voltage with Respect to GND	-0.5 to V _{DD} + 0.5	V
V _{TERM} ^(5,6)	Terminal Voltage with Respect to GND	-0.5 to V _{DDQ} + 0.5	V
T _A ⁽⁷⁾	Commercial Operating Temperature	-0 to +70	°C
	Industrial Operating Temperature	-40 to +85	°C
T _{BIAS}	Temperature Under Bias	-55 to +125	°C
T _{STG}	Storage Temperature	-55 to +125	°C
P _T	Power Dissipation	2.0	W
I _{OUT}	DC Output Current	50	mA

5279 tbl 03

NOTES:

- Stresses greater than those listed under ABSOLUTE MAXIMUM RATINGS may cause permanent damage to the device. This is a stress rating only and functional operation of the device at these or any other conditions above those indicated in the operational sections of this specification is not implied. Exposure to absolute maximum rating conditions for extended periods may affect reliability.
- V_{DD} terminals only.
- V_{DDQ} terminals only.
- Input terminals only.
- I/O terminals only.
- This is a steady-state DC parameter that applies after the power supplies have ramped up. Power supply sequencing is not necessary; however, the voltage on any input or I/O pin cannot exceed V_{DDQ} during power supply ramp up.
- T_A is the "instant on" case temperature.

Recommended Operating Temperature and Supply Voltage

Grade	Temperature ⁽¹⁾	V _{SS}	V _{DD}	V _{DDQ}
Commercial	0°C to +70°C	0V	3.3V±5%	3.3V±5%
Industrial	-40°C to +85°C	0V	3.3V±5%	3.3V±5%

5279 tbl 04

NOTES:

- T_A is the "instant on" case temperature.

Recommended DC Operating Conditions

Symbol	Parameter	Min.	Typ.	Max.	Unit
V _{DD}	Core Supply Voltage	3.135	3.3	3.465	V
V _{DDQ}	I/O Supply Voltage	3.135	3.3	3.465	V
V _{SS}	Supply Voltage	0	0	0	V
V _{IH}	Input High Voltage - Inputs	2.0	—	V _{DD} + 0.3	V
V _{IH}	Input High Voltage - I/O	2.0	—	V _{DDQ} + 0.3 ⁽¹⁾	V
V _{IL}	Input Low Voltage	-0.3 ⁽²⁾	—	0.8	V

5279 tbl 06

NOTES:

- V_{IH} (max) = V_{DDQ} + 1.0V for pulse width less than t_{CYC2}, once per cycle.
- V_{IL} (min) = -1.0V for pulse width less than t_{CYC2}, once per cycle.

100 Pin TQFP Capacitance

(T_A = +25°C, f = 1.0MHz)

Symbol	Parameter ⁽¹⁾	Conditions	Max.	Unit
C _{IN}	Input Capacitance	V _{IN} = 3dV	5	pF
C _{I/O}	I/O Capacitance	V _{OUT} = 3dV	7	pF

5279 tbl 07

NOTE:

- This parameter is guaranteed by device characterization, but not production tested.

Pin Configuration – 128K x 36

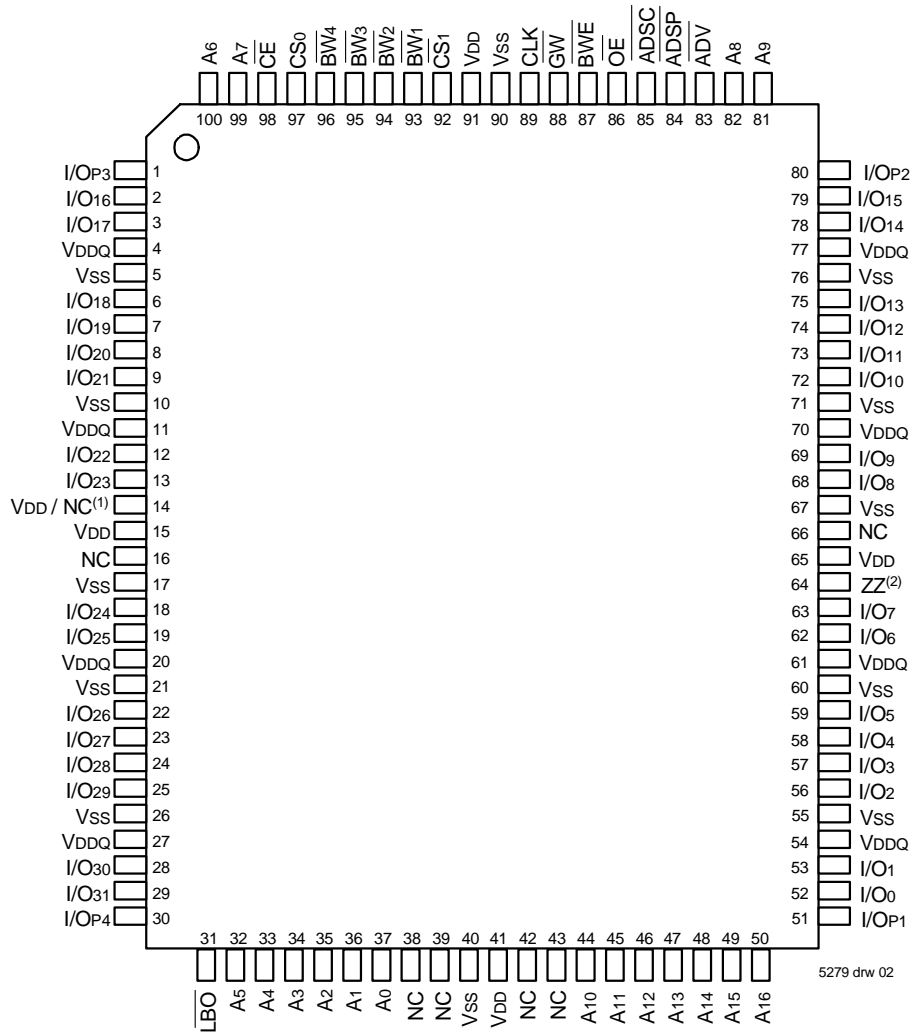

TQFP
Top View

NOTES:

1. Pin 14 can either be directly connected to V_{DD}, or connected to an input voltage $\geq V_{IH}$, or left unconnected.
2. Pin 64 can be left unconnected and the device will always remain in active mode.

Pin Configuration – 256K x 18

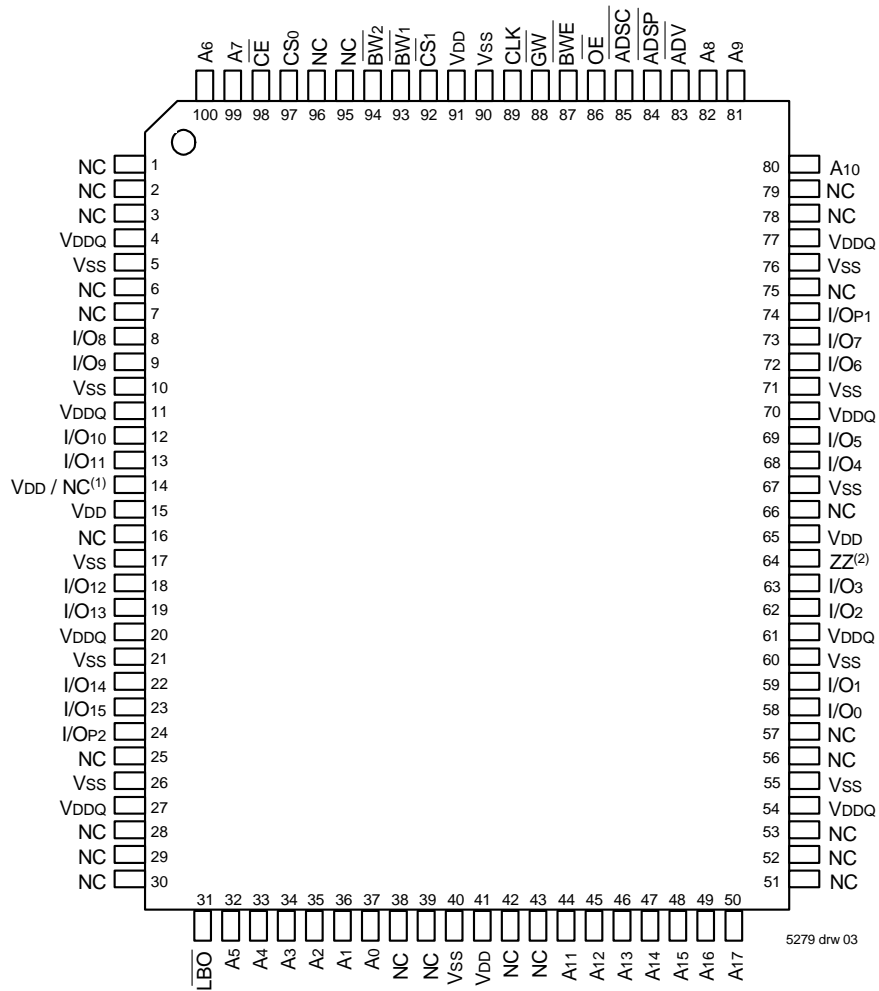

TQFP
Top View

NOTES:

1. Pin 14 can either be directly connected to V_{DD}, or connected to an input voltage $\geq V_{IH}$, or left unconnected.
2. Pin 64 can be left unconnected and the device will always remain in active mode.

DC Electrical Characteristics Over the Operating Temperature and Supply Voltage Range ($V_{DD} = 3.3V \pm 5\%$)

Symbol	Parameter	Test Conditions	Min.	Max.	Unit
$ I_{LI} $	Input Leakage Current	$V_{DD} = \text{Max.}, V_{IN} = 0V \text{ to } V_{DD}$	—	5	μA
$ I_{LZZ} $	ZZ and $\overline{LB0}$ Input Leakage Current ⁽¹⁾	$V_{DD} = \text{Max.}, V_{IN} = 0V \text{ to } V_{DD}$	—	30	μA
$ I_{LO} $	Output Leakage Current	$V_{OUT} = 0V \text{ to } V_{DD0}, \text{ Device Deselected}$	—	5	μA
V_{OL}	Output Low Voltage	$I_{OL} = +8mA, V_{DD} = \text{Min.}$	—	0.4	V
V_{OH}	Output High Voltage	$I_{OH} = -8mA, V_{DD} = \text{Min.}$	2.4	—	V

5279 tbl 08

NOTE:

1. The $\overline{LB0}$ pin will be internally pulled to V_{DD} and the ZZ pin will be internally pulled to V_{SS} if they are not actively driven in the application.

DC Electrical Characteristics Over the Operating Temperature and Supply Voltage Range⁽¹⁾

Symbol	Parameter	Test Conditions	150MHz		133MHz		Unit
			Com'l	Ind	Com'l	Ind	
I_{DD}	Operating Power Supply Current	Device Selected, Outputs Open, $V_{DD} = \text{Max.}, V_{DD0} = \text{Max.}, V_{IN} \geq V_{IH} \text{ or } \leq V_{IL}, f = f_{MAX}^{(2)}$	295	305	250	260	mA
I_{SB1}	CMOS Standby Power Supply Current	Device Deselected, Outputs Open, $V_{DD} = \text{Max.}, V_{DD0} = \text{Max.}, V_{IN} \geq V_{HD} \text{ or } \leq V_{LD}, f = 0^{(2,3)}$	30	35	30	35	mA
I_{SB2}	Clock Running Power Supply Current	Device Deselected, Outputs Open, $V_{DD} = \text{Max.}, V_{DD0} = \text{Max.}, V_{IN} \geq V_{HD} \text{ or } \leq V_{LD}, f = f_{MAX}^{(2,3)}$	105	115	100	110	mA
I_{ZZ}	Full Sleep Mode Supply Current	$ZZ \geq V_{HD}, V_{DD} = \text{Max.}$	30	35	30	35	mA

5279 tbl 09

NOTES:

1. All values are maximum guaranteed values.
2. At $f = f_{MAX}$, inputs are cycling at the maximum frequency of read cycles of $1/t_{CYC}$ while $\overline{ADSC} = \text{LOW}$; $f=0$ means no input lines are changing.
3. For I/Os $V_{HD} = V_{DD0} - 0.2V, V_{LD} = 0.2V$. For other inputs $V_{HD} = V_{DD} - 0.2V, V_{LD} = 0.2V$.

AC Test Conditions ($V_{DD0} = 3.3V$)

Input Pulse Levels	0 to 3V
Input Rise/Fall Times	2ns
Input Timing Reference Levels	1.5V
Output Timing Reference Levels	1.5V
AC Test Load	See Figure 1

5279 tbl 10

AC Test Load

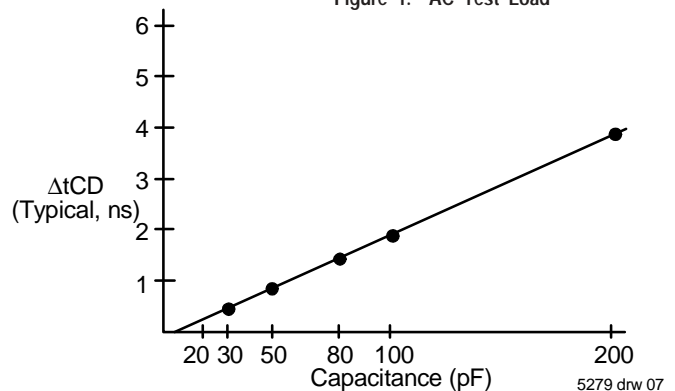
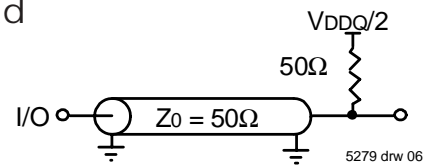

Figure 2. Lumped Capacitive Load, Typical Derating

Synchronous Truth Table^(1,3)

Operation	Address Used	\overline{CE}	CS ₀	\overline{CS}_1	ADSP	ADSC	ADV	GW	BWE	BW _x	\overline{OE} (2)	CLK	I/O
Deselected Cycle, Power Down	None	H	X	X	X	L	X	X	X	X	X	-	HI-Z
Deselected Cycle, Power Down	None	L	X	H	L	X	X	X	X	X	X	-	HI-Z
Deselected Cycle, Power Down	None	L	L	X	L	X	X	X	X	X	X	-	HI-Z
Deselected Cycle, Power Down	None	L	X	H	X	L	X	X	X	X	X	-	HI-Z
Deselected Cycle, Power Down	None	L	L	X	X	L	X	X	X	X	X	-	HI-Z
Read Cycle, Begin Burst	External	L	H	L	L	X	X	X	X	X	L	-	DOUT
Read Cycle, Begin Burst	External	L	H	L	L	X	X	X	X	X	H	-	HI-Z
Read Cycle, Begin Burst	External	L	H	L	H	L	X	H	H	X	L	-	DOUT
Read Cycle, Begin Burst	External	L	H	L	H	L	X	H	L	H	L	-	DOUT
Read Cycle, Begin Burst	External	L	H	L	H	L	X	H	L	H	H	-	HI-Z
Write Cycle, Begin Burst	External	L	H	L	H	L	X	H	L	L	X	-	DIN
Write Cycle, Begin Burst	External	L	H	L	H	L	X	L	X	X	X	-	DIN
Read Cycle, Continue Burst	Next	X	X	X	H	H	L	H	H	X	L	-	DOUT
Read Cycle, Continue Burst	Next	X	X	X	H	H	L	H	H	X	H	-	HI-Z
Read Cycle, Continue Burst	Next	X	X	X	H	H	L	H	X	H	L	-	DOUT
Read Cycle, Continue Burst	Next	X	X	X	H	H	L	H	X	H	H	-	HI-Z
Read Cycle, Continue Burst	Next	H	X	X	X	H	L	H	H	X	L	-	DOUT
Read Cycle, Continue Burst	Next	H	X	X	X	H	L	H	H	X	H	-	HI-Z
Read Cycle, Continue Burst	Next	H	X	X	X	H	L	H	X	H	L	-	DOUT
Read Cycle, Continue Burst	Next	H	X	X	X	H	L	H	X	H	H	-	HI-Z
Write Cycle, Continue Burst	Next	X	X	X	H	H	L	H	L	L	X	-	DIN
Write Cycle, Continue Burst	Next	X	X	X	H	H	L	L	X	X	X	-	DIN
Write Cycle, Continue Burst	Next	H	X	X	X	H	L	H	L	L	X	-	DIN
Write Cycle, Continue Burst	Next	H	X	X	X	H	L	L	X	X	X	-	DIN
Read Cycle, Suspend Burst	Current	X	X	X	H	H	H	H	H	X	L	-	DOUT
Read Cycle, Suspend Burst	Current	X	X	X	H	H	H	H	H	X	H	-	HI-Z
Read Cycle, Suspend Burst	Current	X	X	X	H	H	H	H	X	H	L	-	DOUT
Read Cycle, Suspend Burst	Current	X	X	X	H	H	H	H	X	H	H	-	HI-Z
Read Cycle, Suspend Burst	Current	H	X	X	X	H	H	H	H	X	L	-	DOUT
Read Cycle, Suspend Burst	Current	H	X	X	X	H	H	H	H	X	H	-	HI-Z
Read Cycle, Suspend Burst	Current	H	X	X	X	H	H	H	X	H	L	-	DOUT
Read Cycle, Suspend Burst	Current	H	X	X	X	H	H	H	X	H	H	-	HI-Z
Write Cycle, Suspend Burst	Current	X	X	X	H	H	H	H	L	L	X	-	DIN
Write Cycle, Suspend Burst	Current	X	X	X	H	H	H	L	X	X	X	-	DIN
Write Cycle, Suspend Burst	Current	H	X	X	X	H	H	H	L	L	X	-	DIN
Write Cycle, Suspend Burst	Current	H	X	X	X	H	H	L	X	X	X	-	DIN

- NOTES:
 1. L = V_{IL}, H = V_{IH}, X = Don't Care.
 2. \overline{OE} is an asynchronous input.
 3. ZZ = low for this table.

Synchronous Write Function Truth Table^(1, 2)

Operation	\overline{GW}	BWE	BW ₁	BW ₂	BW ₃	BW ₄
Read	H	H	X	X	X	X
Read	H	L	H	H	H	H
Write all Bytes	L	X	X	X	X	X
Write all Bytes	H	L	L	L	L	L
Write Byte 1 ⁽³⁾	H	L	L	H	H	H
Write Byte 2 ⁽³⁾	H	L	H	L	H	H
Write Byte 3 ⁽³⁾	H	L	H	H	L	H
Write Byte 4 ⁽³⁾	H	L	H	H	H	L

5279 tbl 12

NOTES:

1. L = V_{IL}, H = V_{IH}, X = Don't Care.
2. $\overline{BW_3}$ and $\overline{BW_4}$ are not applicable for the IDT71V3578.
3. Multiple bytes may be selected during the same cycle.

Asynchronous Truth Table⁽¹⁾

Operation ⁽²⁾	\overline{OE}	ZZ	I/O Status	Power
Read	L	L	Data Out	Active
Read	H	L	High-Z	Active
Write	X	L	High-Z - Data In	Active
Deselected	X	L	High-Z	Standby
Sleep Mode	X	H	High-Z	Sleep

5279 tbl 13

NOTES:

1. L = V_{IL}, H = V_{IH}, X = Don't Care.
2. Synchronous function pins must be biased appropriately to satisfy operation requirements.

Interleaved Burst Sequence Table ($\overline{LBO}=V_{DD}$)

	Sequence 1		Sequence 2		Sequence 3		Sequence 4	
	A1	A0	A1	A0	A1	A0	A1	A0
First Address	0	0	0	1	1	0	1	1
Second Address	0	1	0	0	1	1	1	0
Third Address	1	0	1	1	0	0	0	1
Fourth Address ⁽¹⁾	1	1	1	0	0	1	0	0

5279 tbl 14

NOTE:

1. Upon completion of the Burst sequence the counter wraps around to its initial state.

Linear Burst Sequence Table ($\overline{LBO}=V_{SS}$)

	Sequence 1		Sequence 2		Sequence 3		Sequence 4	
	A1	A0	A1	A0	A1	A0	A1	A0
First Address	0	0	0	1	1	0	1	1
Second Address	0	1	1	0	1	1	0	0
Third Address	1	0	1	1	0	0	0	1
Fourth Address ⁽¹⁾	1	1	0	0	0	1	1	0

5279 tbl 15

NOTE:

1. Upon completion of the Burst sequence the counter wraps around to its initial state.

AC Electrical Characteristics

(VDD = 3.3V ±5%, Commercial and Industrial Temperature Ranges)

Symbol	Parameter	150MHz		133MHz		Unit
		Min.	Max.	Min.	Max.	
t _{CYC}	Clock Cycle Time	6.7	—	7.5	—	ns
t _{CH} ⁽¹⁾	Clock High Pulse Width	2.6	—	3	—	ns
t _{CL} ⁽¹⁾	Clock Low Pulse Width	2.6	—	3	—	ns
Output Parameters						
t _{CD}	Clock High to Valid Data	—	3.8	—	4.2	ns
t _{DC}	Clock High to Data Change	1.5	—	1.5	—	ns
t _{CLZ} ⁽²⁾	Clock High to Output Active	0	—	0	—	ns
t _{CHZ} ⁽²⁾	Clock High to Data High-Z	1.5	3.8	1.5	4.2	ns
t _{OE}	Output Enable Access Time	—	3.8	—	4.2	ns
t _{OLZ} ⁽²⁾	Output Enable Low to Output Active	0	—	0	—	ns
t _{OHZ} ⁽²⁾	Output Enable High to Output High-Z	—	3.8	—	4.2	ns
Set Up Times						
t _{SA}	Address Setup Time	1.5	—	1.5	—	ns
t _{SS}	Address Status Setup Time	1.5	—	1.5	—	ns
t _{SD}	Data In Setup Time	1.5	—	1.5	—	ns
t _{SW}	Write Setup Time	1.5	—	1.5	—	ns
t _{SAV}	Address Advance Setup Time	1.5	—	1.5	—	ns
t _{SC}	Chip Enable/Select Setup Time	1.5	—	1.5	—	ns
Hold Times						
t _{HA}	Address Hold Time	0.5	—	0.5	—	ns
t _{HS}	Address Status Hold Time	0.5	—	0.5	—	ns
t _{HD}	Data In Hold Time	0.5	—	0.5	—	ns
t _{HW}	Write Hold Time	0.5	—	0.5	—	ns
t _{HAV}	Address Advance Hold Time	0.5	—	0.5	—	ns
t _{HC}	Chip Enable/Select Hold Time	0.5	—	0.5	—	ns
Sleep Mode and Configuration Parameters						
t _{ZZPW}	ZZ Pulse Width	100	—	100	—	ns
t _{ZZR} ⁽³⁾	ZZ Recovery Time	100	—	100	—	ns
t _{CFG} ⁽⁴⁾	Configuration Set-up Time	27	—	30	—	ns

5279 tbl 16

NOTES:

1. Measured as HIGH above V_{IH} and LOW below V_{IL}.
2. Transition is measured ±200mV from steady-state.
3. Device must be deselected when powered-up from sleep mode.
4. t_{CFG} is the minimum time required to configure the device based on the $\overline{\text{LBO}}$ input. $\overline{\text{LBO}}$ is a static input and must not change during normal operation.

Timing Waveform of Pipelined Read Cycle^(1,2)

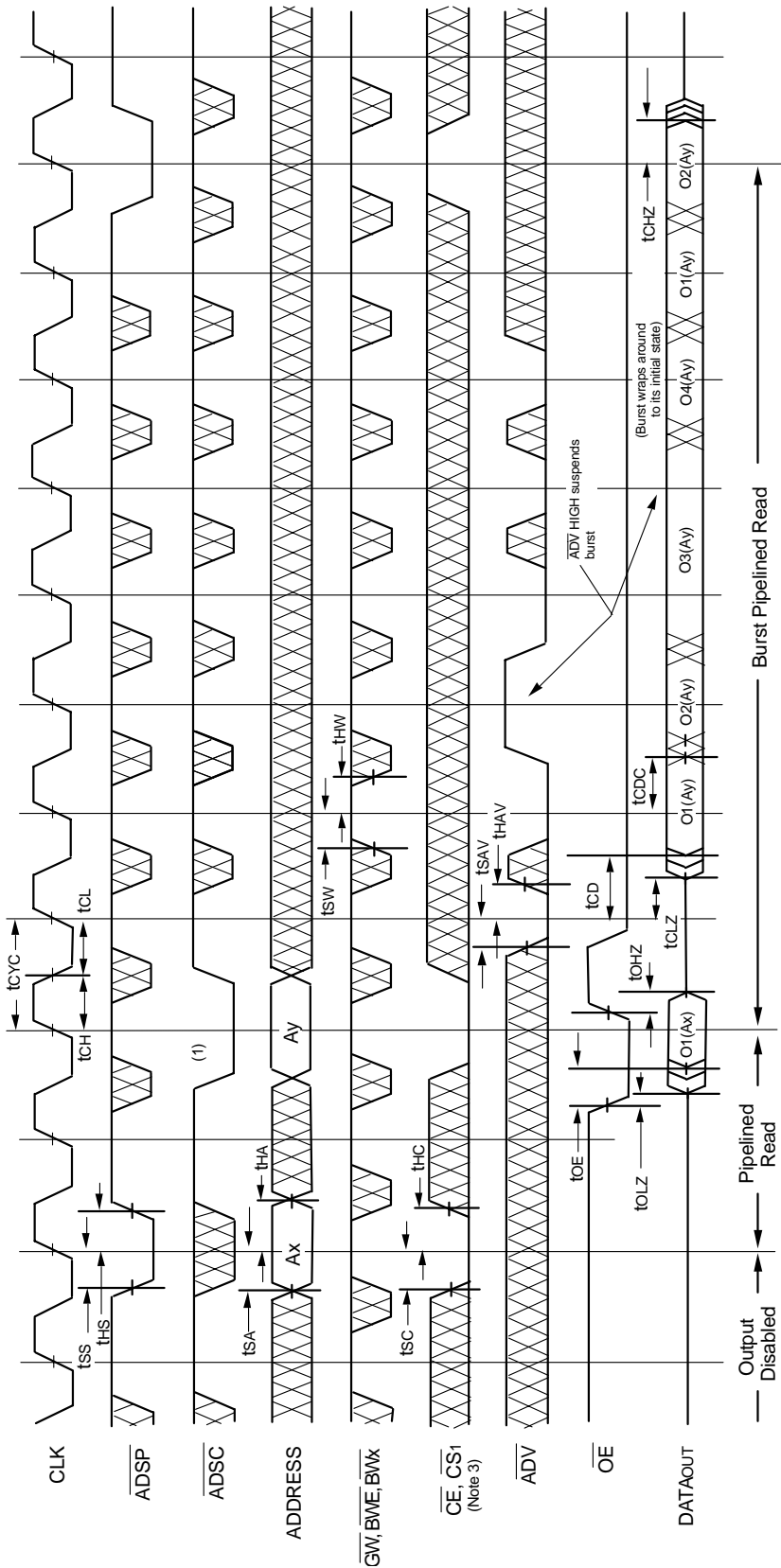

5279 drw 08

NOTES:

1. O1 (Ax) represents the first output from the external address Ax. O1 (Ay) represents the first output from the external address Ay; O2 (Ay) represents the next output data in the burst sequence of the base address Ay, etc. where A0 and A1 are advancing for the four word burst in the sequence defined by the state of the LBO input.
2. ZZ input is LOW and LBO is Don't Care for this cycle.
3. CS0 limiting transitions are identical but inverted to the CE and CS1 signals. For example, when CE and CS1 are LOW on this waveform, CS0 is HIGH.

Timing Waveform of Combined Pipelined Read and Write Cycles^(1,2,3)

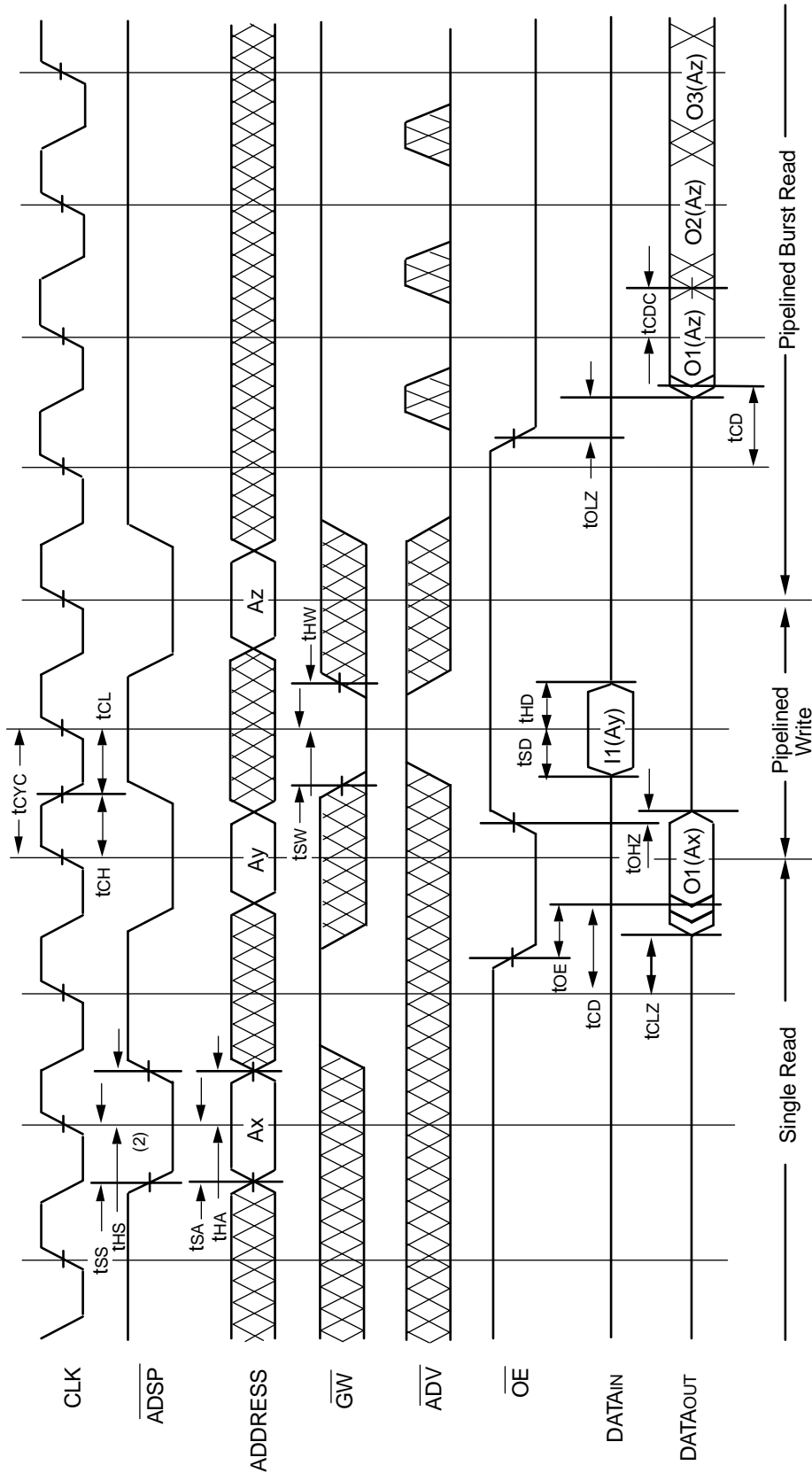

5279 drw 09

NOTES:

1. Device is selected through entire cycle; \overline{CE} and $\overline{CS1}$ are LOW, $\overline{CS0}$ is HIGH.
2. Zz input is LOW and \overline{LBO} is Don't Care for this cycle.
3. O1(Ax) represents the first output from the external address Ax. I1(Ay) represents the first input from the external address Ay. O1(Az) represents the first output from the external address Az. O2(Az) represents the next output data in the burst sequence of the base address Az, etc. where A0 and A1 are advancing for the four word burst in the sequence defined by the state of the \overline{LBO} input.

Timing Waveform of Write Cycle No. 1 - **GW** Controlled^(1,2,3)

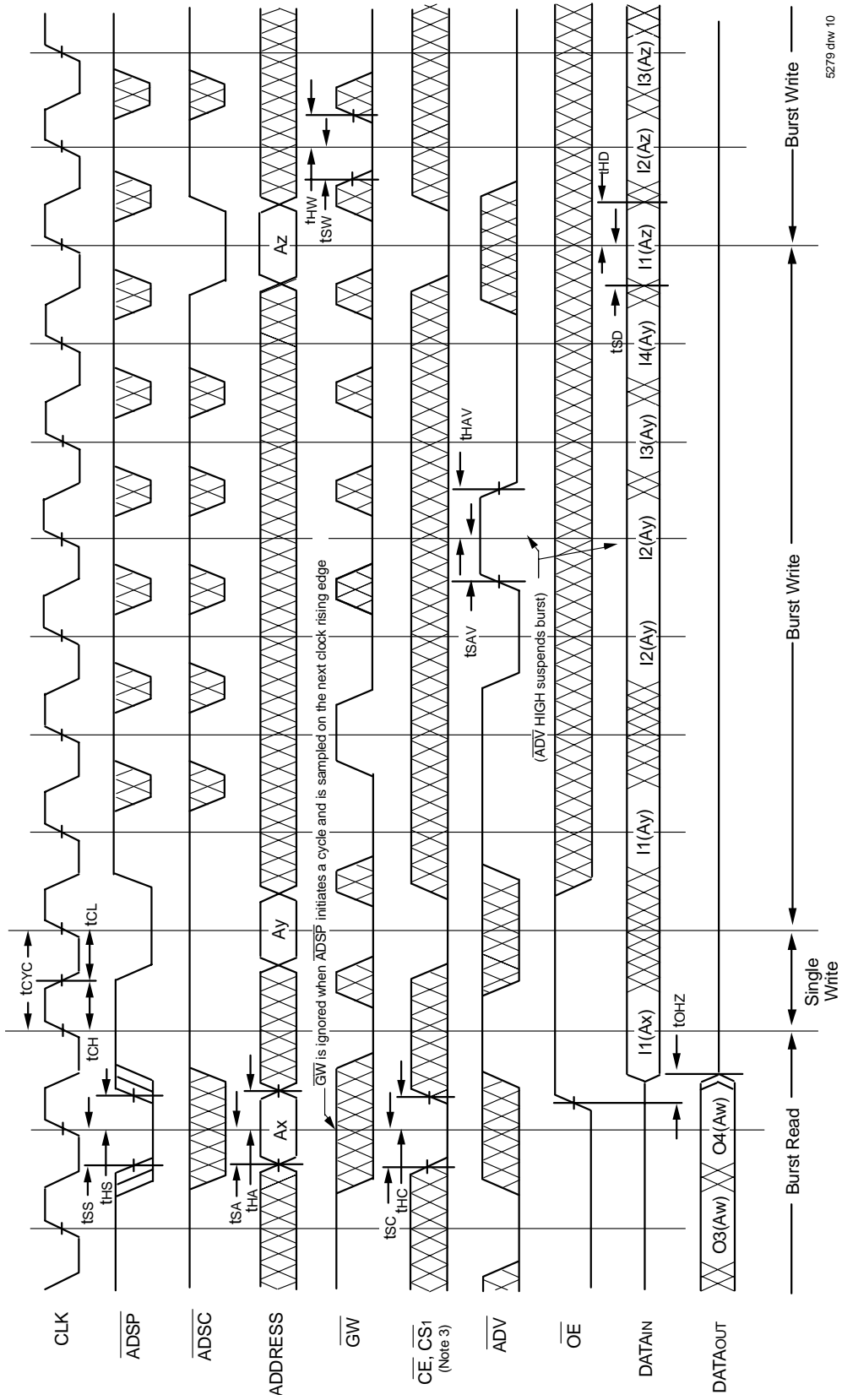

5279 drw 10

NOTES:

1. ZZ input is LOW, BWE is HIGH and LBO is Don't Care for this cycle.
2. O4(Aw) represents the final output data in the burst sequence of the base address Aw. I1(Ax) represents the first input from the external address Ax. I1(Ay) represents the first input from the external address Ay. I2(Ay) represents the next input data in the burst sequence of the base address Ay, etc. where A0 and A1 are advancing for the four word burst in the sequence defined by the state of the LBO input. In the case of input I2(Ay) this data is valid for two cycles because ADV is high and has suspended the burst.
3. CS0 timing transitions are identical but inverted to the CE and CS1 signals. For example, when CE and CS1 are LOW on this waveform, CS0 is HIGH.

Timing Waveform of Write Cycle No. 2 - Byte Controlled^(1,2,3)

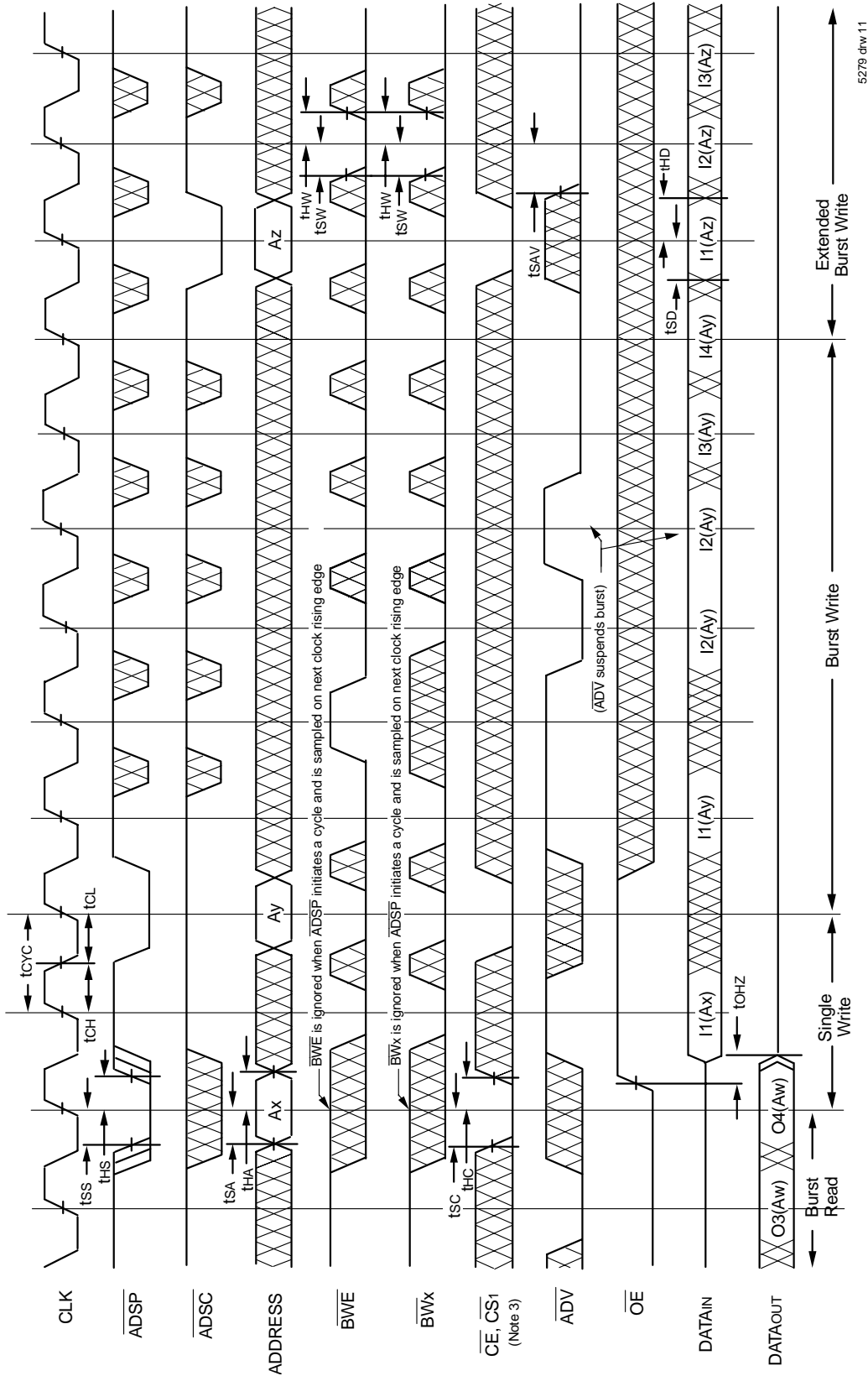

NOTES:

1. Zz input is LOW, \overline{GW} is HIGH and \overline{LBO} is Don't Care for this cycle.
2. O4(Aw) represents the final output data in the burst sequence of the base address Aw. I1(Ax) represents the first input from the external address Ax. I1(Ay) represents the first input from the external address Ay; I2(Ay) represents the next input data in the burst sequence of the base address Ay, etc. where A0 and A1 are advancing for the four word burst in the sequence defined by the state of the \overline{LBO} input. In the case of input I2(Ay) this data is valid for two cycles because ADV is high and has suspended the burst.
3. CS0 timing transitions are identical but inverted to the CE and $\overline{CS1}$ signals. For example, when CE and $\overline{CS1}$ are LOW on this waveform, CS0 is HIGH.

Timing Waveform of Sleep (ZZ) and Power-Down Modes^(1,2,3)

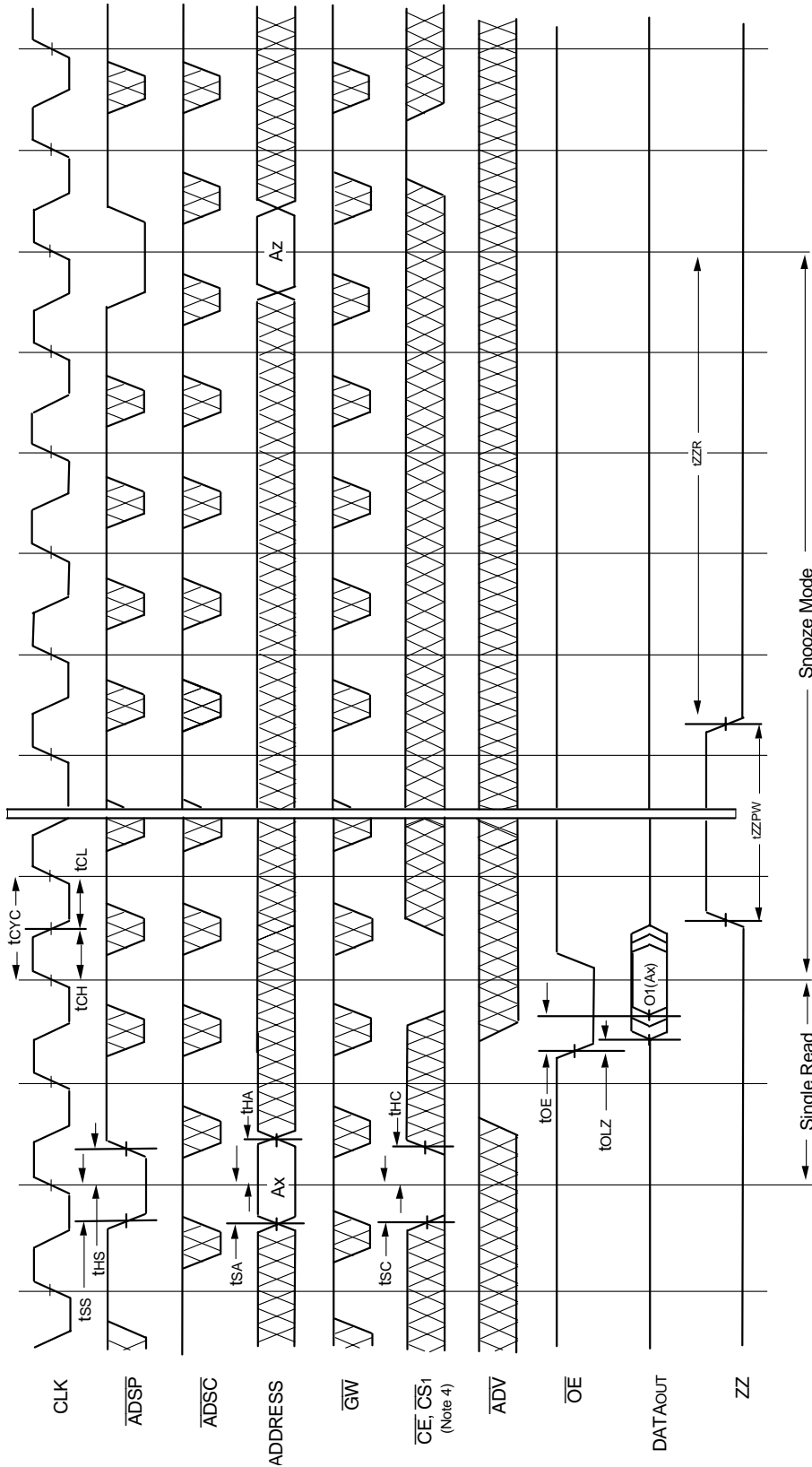

5279.drw 12

NOTES:

1. Device must power up in deselected Mode
2. LBO is Don't Care for this cycle.
3. It is not necessary to retain the state of the input registers throughout the Power-down cycle.
4. CS₀ timing transitions are identical but inverted to the \overline{CE} and $\overline{CS1}$ signals. For example, when \overline{CE} and $\overline{CS1}$ are LOW on this waveform, CS₀ is HIGH.

Non-Burst Read Cycle Timing Waveform

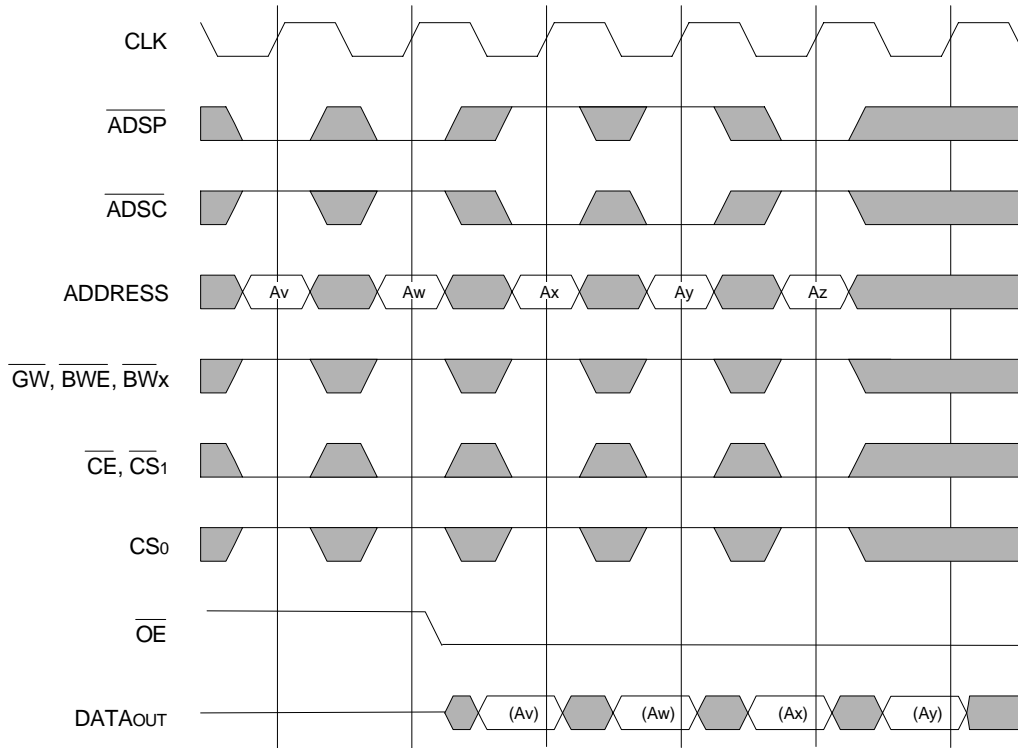

NOTES:

1. ZZ input is LOW, \overline{ADV} is HIGH and \overline{LBO} is Don't Care for this cycle.
2. (Ax) represents the data for address Ax, etc.
3. For read cycles, ADSP and ADSC function identically and are therefore interchangeable.

5279 drw 14

Non-Burst Write Cycle Timing Waveform

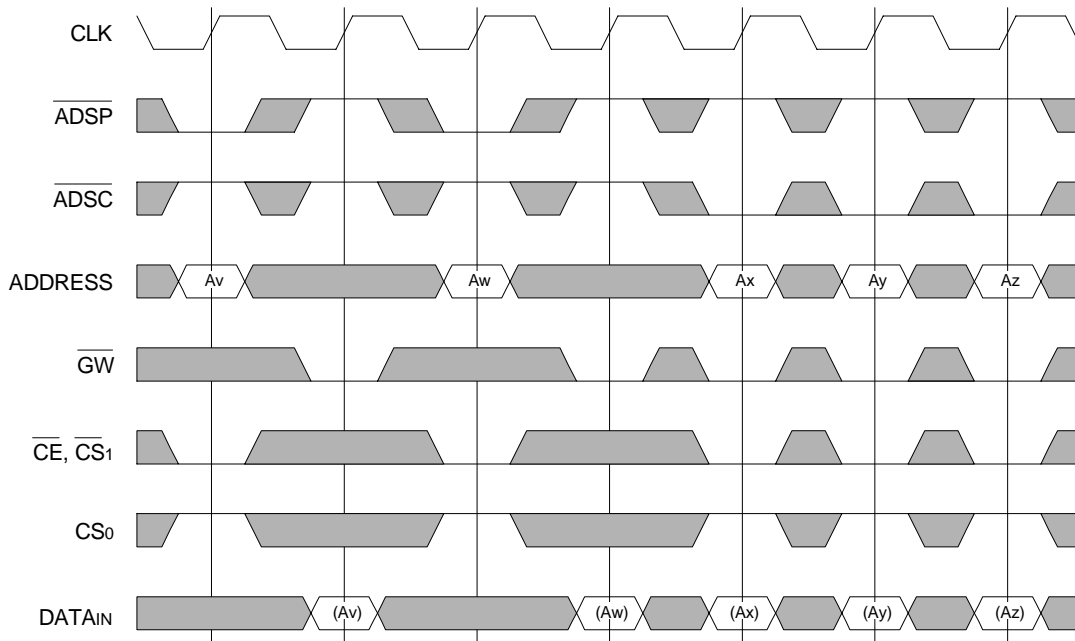

NOTES:

1. ZZ input is LOW, \overline{ADV} and \overline{OE} are HIGH, and \overline{LBO} is Don't Care for this cycle.
2. (Ax) represents the data for address Ax, etc.
3. Although only \overline{GW} writes are shown, the functionality of \overline{BWE} and \overline{BWx} together is the same as \overline{GW} .
4. For write cycles, \overline{ADSP} and \overline{ADSC} have different limitations.

5279 drw 15

Ordering Information

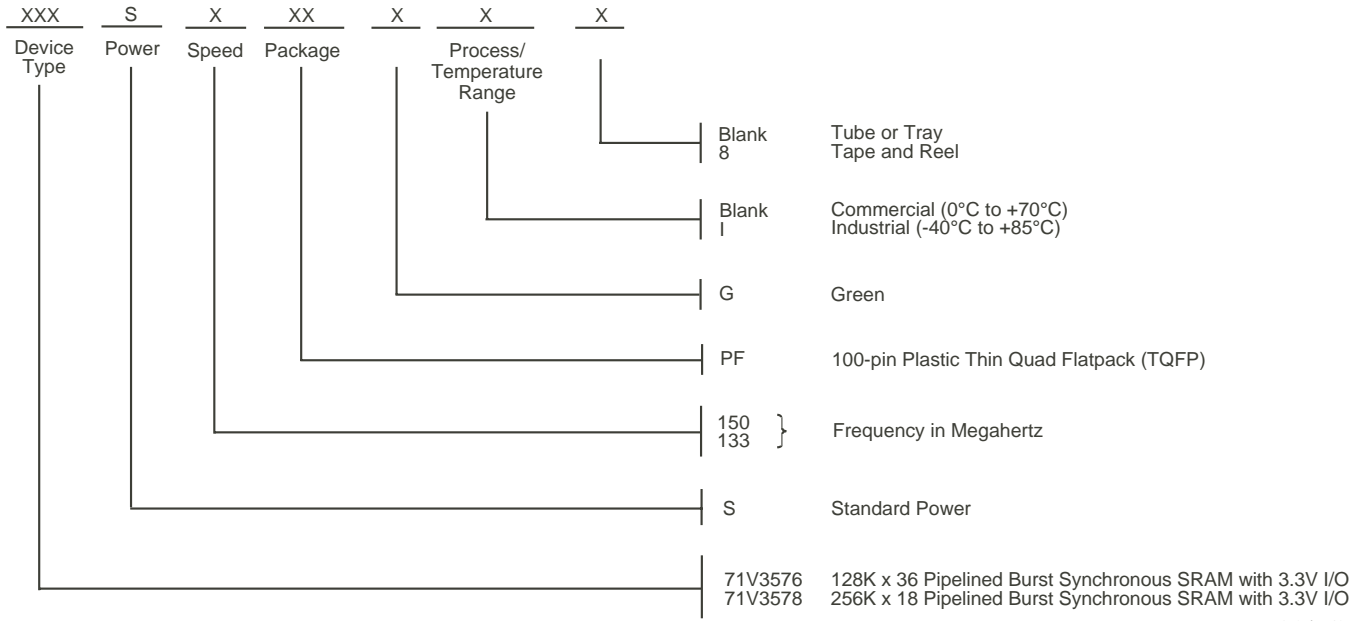

5279 drw 13

Package Information

100-Pin Thin Quad Plastic Flatpack (TQFP)

Information available on the IDT website

Datasheet Document History

7/26/99		Updated to new format
9/17/99	Pg. 8	Revised ISB1 and IZZ for speeds 100–200MHz
	Pg. 11	Revised tCDC (min.) at 166MHz
	Pg. 18	Added 119 BGA package diagram
	Pg. 20	Added Datasheet Document History
12/31/99	Pg. 1, 8, 11, 19	Removed 166, 183, and 200MHz speed grade offerings (see IDT71V35761 and IDT71V35781)
	Pg. 1, 4, 8, 11, 19	Added Industrial Temperature range offerings
04/04/00	Pg. 18	Added 100TQFP Package Diagram Outline
	Pg. 4	Add capacitance table for the BGA package; Add Industrial temperature to table; Insert note to Absolute Max Rating and Recommended Operating Temperature tables
	Pg. 7	Add note to BGA pin configurations; corrected typo in pinout
06/01/00		Add new package offering, 13 x 15mm fBGA
	Pg. 20	Correct BG119 Package Diagram Outline
07/15/00	Pg. 7	Add note reference to BG119 pinout
	Pg. 8	Add DNU reference note to BQ165 pinout
	Pg. 20	Update BG119 Package Diagram Outline Dimensions
10/25/00		Remove Preliminary Status
	Pg. 8	Add reference note to pin N5 on BQ165 pinout, reserved for JTAG $\overline{\text{TRST}}$
04/22/03	Pg. 4	Updated 165 BGA table information from TBD to 7
06/30/03	Pg. 1,2,3,5-9	Updated datasheet with JTAG information
	Pg. 5-8	Removed note for NC pins (38,39(PF package); L4, U4 (BG package) H2, N7 (BQ package)) requiring NC or connection to Vss.
	Pg. 19,20	Added two pages of JTAG Specification, AC Electrical, Definitions and Instructions
	Pg. 21-23	Removed old package information from the datasheet
	Pg. 24	Updated ordering information with JTAG and Y stepping information. Added information regarding packages available IDT website.
01/01/04	Pg.21	Added "Restricted hazardous substance device" to ordering information.
01/20/10	Pg.1,2,4,7,8	Combined S and YS datasheet into one datasheet. Deleted JTAG and packages BGA, fBGA.
	Pg.19,20,21	Removed "IDT" from orderable part number.
02/25/12	Pg.1,2,3,7,17	Removed YS. Deleted JTAG info from Functional Block diagram and Ordering information. Deleted JTAG pins TMS, TDI, TCK and TDO from 3 tables. Updated ordering information to include tube or tray and tape & reel.
02/08/13	Pg.1	Removed IDT in reference to fabrication.
	Pg.17	Updated the wording from Restricted Hazardous Substance Device to Green in the Ordering Information.
12/10/15	Pg. 17	Amended the Ordering Information drawing to restore the visibility of this information.



CORPORATE HEADQUARTERS
6024 Silver Creek Valley Road
San Jose, CA 95138

for SALES:
800-345-7015 or
408-284-8200
fax: 408-284-2775
www.idt.com

for Tech Support:
sramhelp@idt.com
408-284-4532

Looking for pricing, stock, or lifecycle information?

Click below to explore more details on WIN SOURCE:

-  [View IDT71V3576S150PF on WIN SOURCE](#)
-  [IDT, Integrated Device Technology Inc Information](#)

Optimize Your Supply Chain with WIN SOURCE Solutions

-  Global Sourcing Solution
-  Obsolete Management
-  Cost Control Management
-  Shortage Management
-  Alternative Solution
-  Excess Inventory Management