



**THE DATASHEET OF  
12VR1S20F4N103B1**





# Series 12VR

## 12mm Panel Potentiometer w/Illuminated Shaft

- Compact 12mm package size
- Single, dual and tri-color LED backlit shaft
- Rotational life (30,000 cycles)
- Switch life (20,000 cycles)
- Variety of standard resistances & tapers

### Applications

- Consumer portable electronics
- Commercial appliances
- Instrument amplifiers and guitar effects
- Keyboards and synthesizers
- Communications equipment

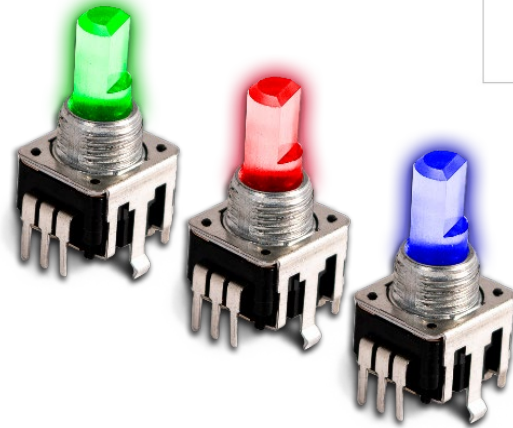

### Ordering Information

Series	LED Option	Terminal Configuration	Shaft Length	Shaft Trim	LED Color	Detent Option	Resistance Code	Resistance Taper
12VR	3	H	20	B	T	N	103	B1

Code	Spec.
H	Vertical/Rear Mount Thread Bushing, PC Pins
S	Horizontal/Side Mount Thread Bushing, PC Pins

Code	Spec.
B	Knurled (18 teeth)
F	Flatted

Code	Spec.
1	Red
2	Blue
3	Orange
4	White
5	Green
A	Blue/Orange
B	Green/Red
C	Blue/Green
D	Green/Orange
E	Blue/Red
T	Red/Green/Blue

Code	Spec.
N	No Detent

Code	Spec.*
A3	15% Log
B1	linear
C3	15% Antilog

Code	Spec.
1	1-Color (no switch)
2	2-Color (w/switch)
3	3-Color (w/switch)

Code	Spec.
15	15 mm
20	20 mm

Code	Spec.
502	5kΩ
103	10kΩ
203	20kΩ
503	50kΩ
104	100kΩ
254	250kΩ

\* Other JIS tapers are available. See charts.



## Electrical Specifications

		Min	Typical	Max	Unit
Total Resistance Tolerance	<250kΩ	-20	–	+20	%
	≥250kΩ	-30	–	+30	%
Power Rating		–	+0.05	–	watt
Operating Voltage		–	–	+50	VAC
		–	–	+10	VDC
Residual Resistance	10kΩ to 50kΩ	–	–	30	Ω
	>50kΩ	–	–	1	%
Slider Noise		–	–	+100	mV
Switch Rating	@ 5 VDC	–	+10	–	mA
Switch Contact Resistance		–	–	+100	mΩ
LED Reverse Voltage		–	+5	–	VDC
Insulation Resistance	250 VDC for 1 min.	+100			MΩ
Dielectric Strength	300 VAC for 1 min. no arcing				
Taper	Linear and audio options (see charts)				

## Mechanical

Total Mechanical Travel	300° ± 5°				
Operating Torque	No switch	10 to 120 gf-cm			
	With switch	10 to 80 gf-cm			
Shaft Wobble	0.7 x L/30mm p-p max.; L = Shaft Length				
Shaft Push-Pull Strength	8 kgf for 10 sec.				
Stop Strength	3 kgf-cm min.				
Rotational Life	No switch	15,000 cycles			
	With switch	30,000 cycles			
Switch Life	20,000 cycles				
Switch Type	SPST – Momentary Push				
Switch Stroke	0.30 ± 0.15 mm				
Shaft Push Force	450 ± 200 gf max.				
Panel Nut Tightening Torque	10 kgf-cm				
IP Rating	40				
Mounting Hardware	One flat washer and one mounting hex nut supplied with each unit				
Packaging	Tray. <a href="#">Furnish with washer and nut in separate package.</a>				
Weight	4 grams				

## Environmental

	Min	Typical	Max	Unit
Operating Temperature	-10	–	+70	°C
Storage Temperature	-30	–	+70	°C
Soldering Conditions				
Wave Solder	Preheat: 100°C max for 2 min max; Solder temperature: 260°C ± 5°C for 5 sec max.; No clean foam flux recommended			
Manual Solder	350°C ± 5°C for 3 sec max.; Sn95Ag5 no clean solder			
Wash	Not recommended			
Moisture Sensitivity Level	1			
ESD Classification (HBM)	Not applicable			

All testing is performed at room ambient conditions except as noted. Users should verify device actual performance in their specific applications  
 This product is compliant to RoHS3 Directive 2015/863 Amendments of Annex II on 31 March 2015, and REACH SVHC Directive EC 1907/2006 Amendments of Annex XIV & Annex XVII on 10 June 2022.  
 Custom and value-added options available on request. Please contact your sales representative for additional information.

## LED Specifications

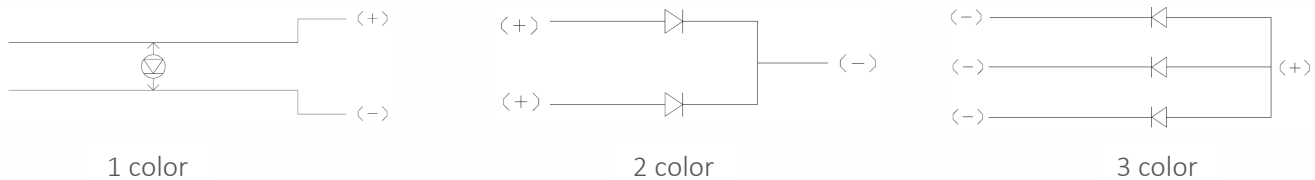

Emitted Color	Power Dissipation (mW)	DC Forward Current (mA)	Test Condition IF = 20 mA			
			Forward Voltage (V)			
			Minimum	Typical	Maximum	
Red	60	30	—	1.8	2.6	
Blue	72	20	—	3.2	3.6	
Orange	100	30	—	2.1	2.6	
White	72	20	—	3.2	3.6	
Green	72	20	—	3.2	3.6	
Blue/Orange	Blue	75	20	2.7	3.3	3.7
	Orange	60	25	1.7	2.0	2.4
Green/Red	Green	95	25	2.7	3.3	3.7
	Red	60	25	1.7	2.0	2.4
Blue/Green	Blue	75	20	2.7	3.3	3.7
	Green	95	25	2.7	3.3	3.7
Green/Orange	Green	95	25	2.7	3.3	3.7
	Orange	60	25	1.7	2.0	2.4
Blue/Red	Blue	75	20	2.7	—	3.7
	Red	60	25	1.7	—	2.4
Red/Green/Blue	Red	60	25	1.7	2.0	2.4
	Green	110	25	2.7	3.3	3.7
	Blue	110	25	2.7	3.3	3.7

### Mechanical Specifications

#### Series 12VR Horizontal/Side Mount with 1-Color LED

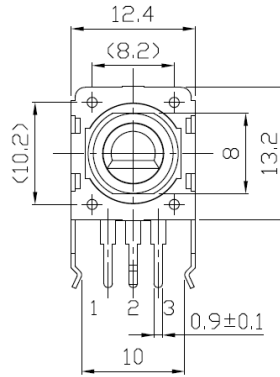
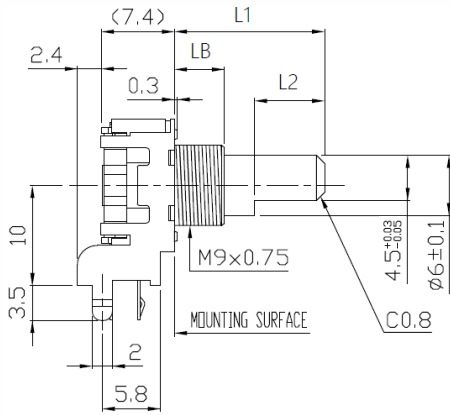

SHAFT SHOWN IN CENTER POSITION  
OR CENTER CLICK POSITION

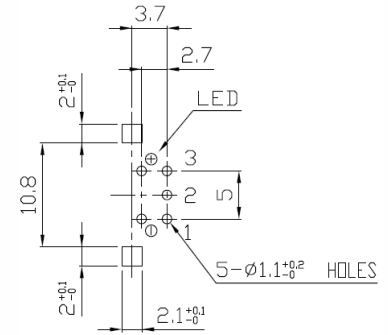

P.C.B. MOUNTING DETAIL  
(TOLERANCE±0.1)  
\*VIEWED FROM MOUNTING SIDE  
(P.C.B) t=1.4mm

#### Series 12VR Vertical/Rear Mount with 1-Color LED

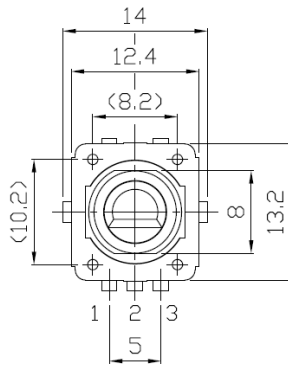
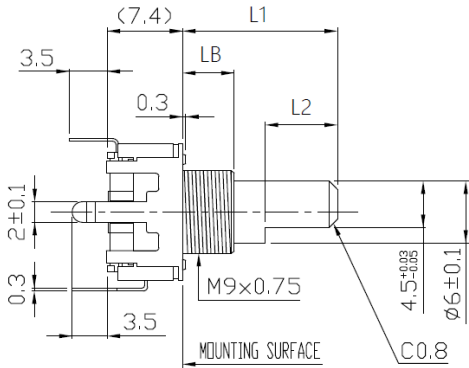

SHAFT SHOWN IN CENTER POSITION  
OR CENTER CLICK POSITION

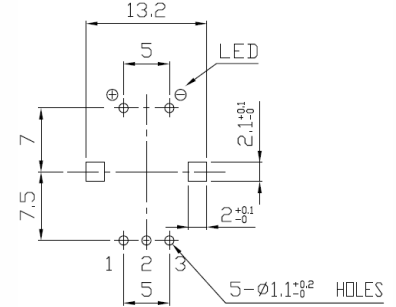

P.C.B. MOUNTING DETAIL  
(TOLERANCE±0.1)  
\*VIEWED FROM MOUNTING SIDE  
(P.C.B) t=1.6mm

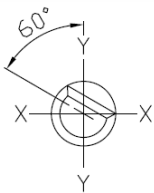

SHAFT SHOWN IN FULL CCW POSITION

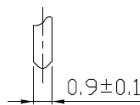

TERMINAL DETAIL

#### CIRCUIT DIAGRAM

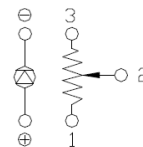

TOLERANCES UNLESS OTHERWISE SPEC	
$L \leq 10$	$\pm 0.3$
$10 < L \leq 100$	$\pm 0.5$
$100 < L$	$\pm 0.8$
ANGULAR DIMENSION	$\pm 5^\circ$

Unit: mm

### Mechanical Specifications

#### Series 12VR Horizontal/Side Mount with 2-Color LED

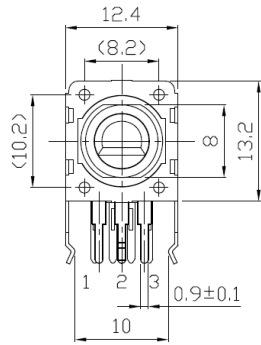
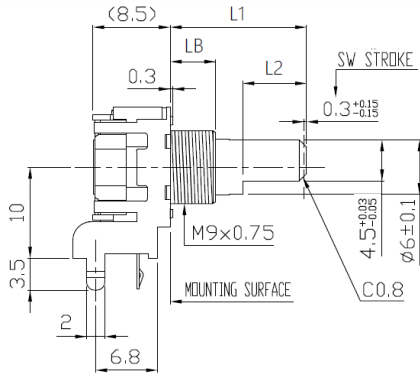

SHAFT SHOWN IN CENTER POSITION OR CENTER CLICK POSITION

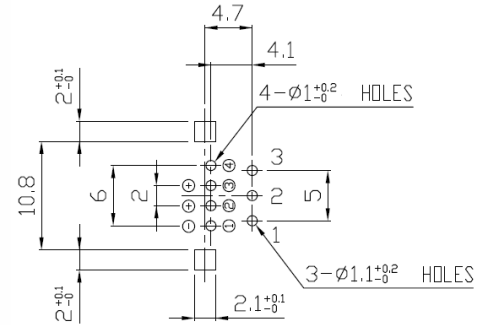

P.C.B. MOUNTING DETAIL (TOLERANCE±0.1)  
\*VIEWED FROM MOUNTING SIDE  
(P.C.B) t=1.4mm

#### Series 12VR Vertical/Rear Mount with 2-Color LED

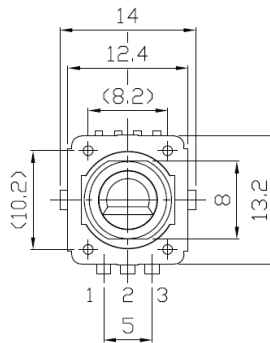
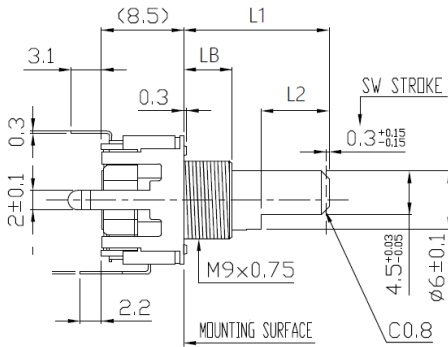

SHAFT SHOWN IN CENTER POSITION OR CENTER CLICK POSITION

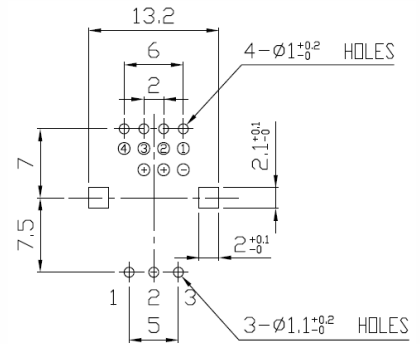

P.C.B. MOUNTING DETAIL (TOLERANCE±0.1)  
\*VIEWED FROM MOUNTING SIDE  
(P.C.B) t=1.4mm

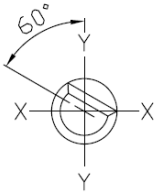

SHAFT SHOWN IN FULL CCW POSITION



TERMINAL DETAIL

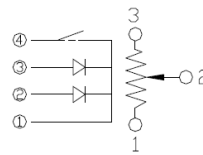

CIRCUIT DIAGRAM

TOLERANCES UNLESS OTHERWISE SPEC.	
L ≤ 10	±0.3
10 < L ≤ 100	±0.5
100 < L	±0.8
ANGULAR DIMENSION	±5°

Unit: mm

### Mechanical Specifications

#### Series 12VR Horizontal/Side Mount with 3-Color LED

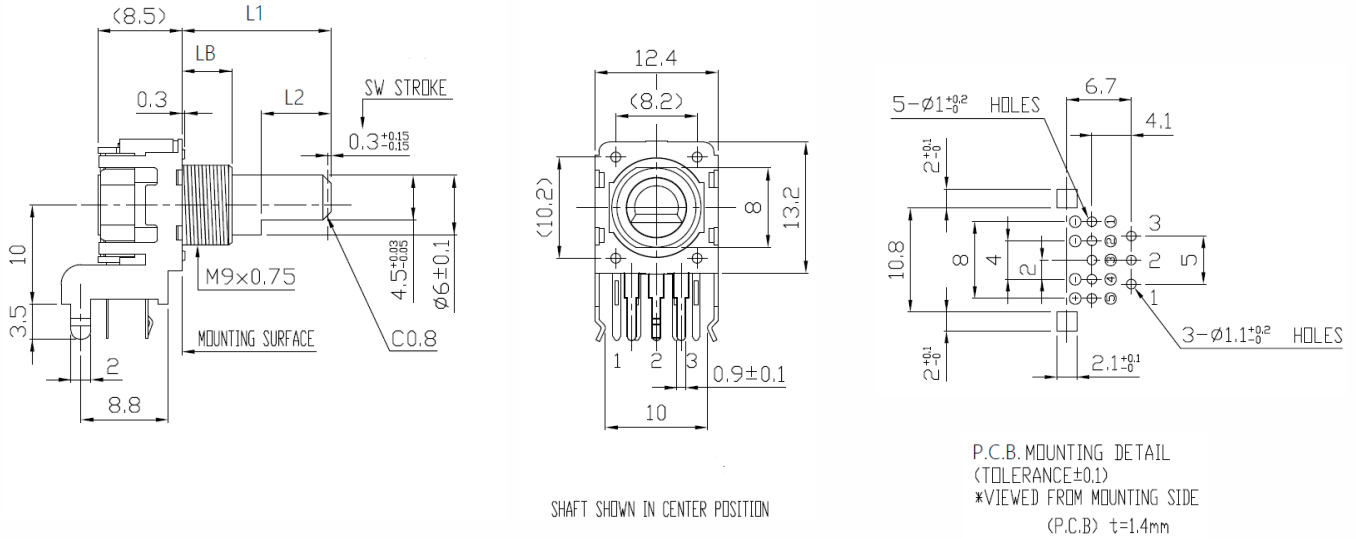

#### Series 12VR Vertical/Rear Mount with 3-Color LED

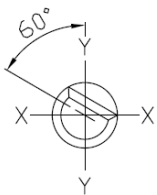
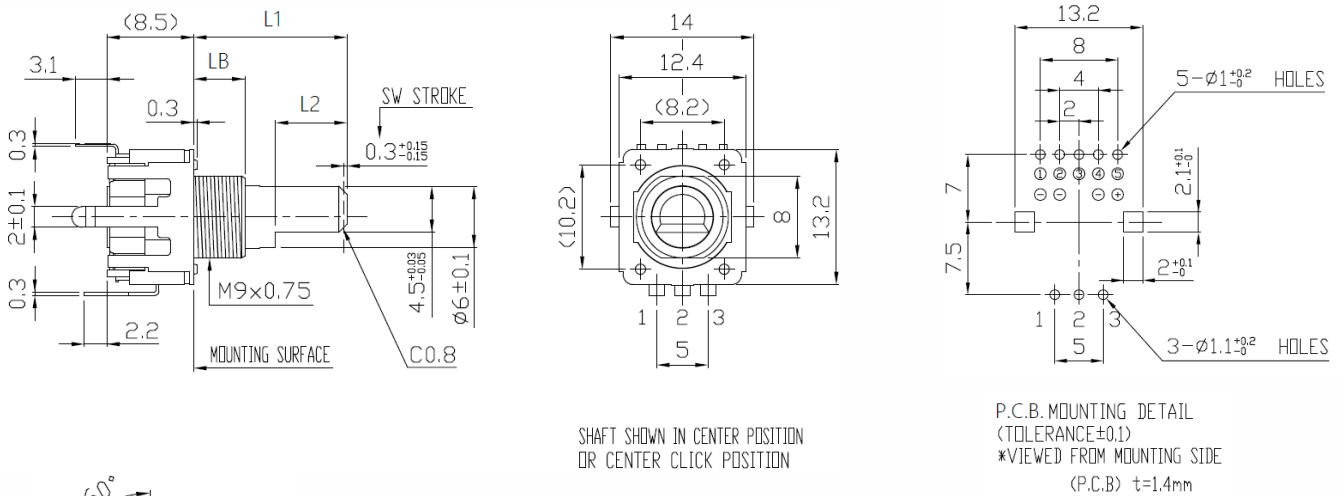

SHAFT SHOWN IN FULL CCW POSITION

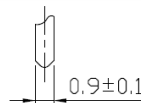

TERMINAL DETAIL

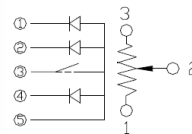

CIRCUIT DIAGRAM

TOLERANCES UNLESS OTHERWISE SPEC	
$L \leq 10$	$\pm 0.3$
$10 < L \leq 100$	$\pm 0.5$
$100 < L$	$\pm 0.8$
ANGULAR DIMENSION	$\pm 5^\circ$

Unit: mm

### Mechanical Specifications

#### Series 12VR Shaft Trim Options

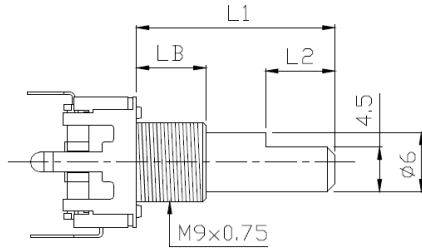

Flatted Shaft

LENGTH		
L1	L2	LB
15	7	5
20	7	7

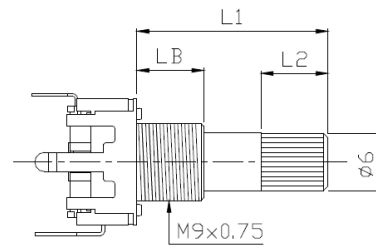

18 Tooth Knurled Shaft

LENGTH		
L1	L2	LB
15	7	5
20	7	7

### Electrical Specification

#### Series 12VR Taper Graphs

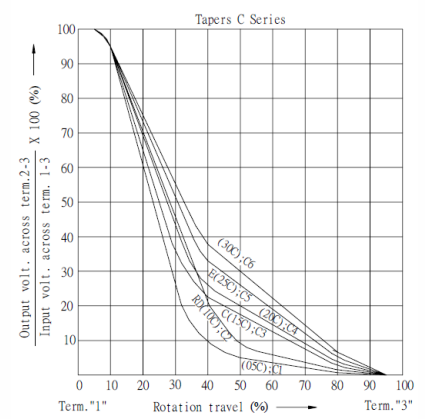
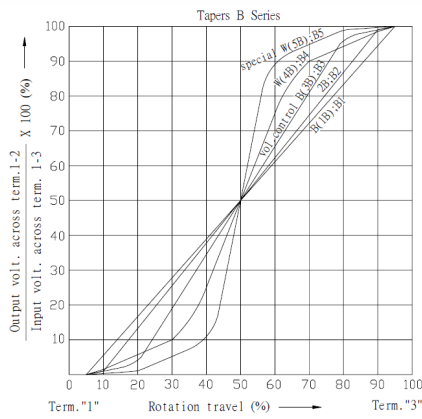
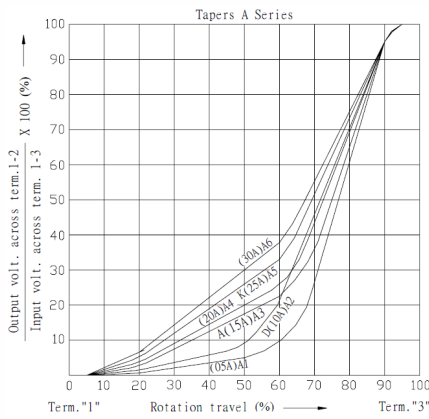

## Looking for pricing, stock, or lifecycle information?

Click below to explore more details on WIN SOURCE:

 [View 12VR1S20F4N103B1 on WIN SOURCE](#)

 [CTS Electrocomponents Information](#)

## Optimize Your Supply Chain with WIN SOURCE Solutions

-  Global Sourcing Solution
-  Obsolete Management
-  Cost Control Management
-  Shortage Management
-  Alternative Solution
-  Excess Inventory Management