



**THE DATASHEET OF
FN14074_STELLA-HB**



STELLA-HB

~75° high bay beam for warehouse and outdoor lighting. Compatible with up to 30 mm LES size. Variant with black frame. COBs.

SPECIFICATION:

Dimensions	Ø 90.0
Height	19.5 mm
Fastening	screw
Ingress protection classes	IP67
ROHS compliant	yes ⓘ



MATERIALS:

Component	Type	Material	Colour	Finish	Length (mm)
STELLA-FRAME	Holder	PA66	black		
STELLA-HB	Single lens	Silicone	clear		

ORDERING INFORMATION:

Component		Qty in box	MOQ	MPQ	Box weight (kg)
FN14074_STELLA-HB	Single lens	135	135	15	7.9
» Box size: 480 x 280 x 300 mm					

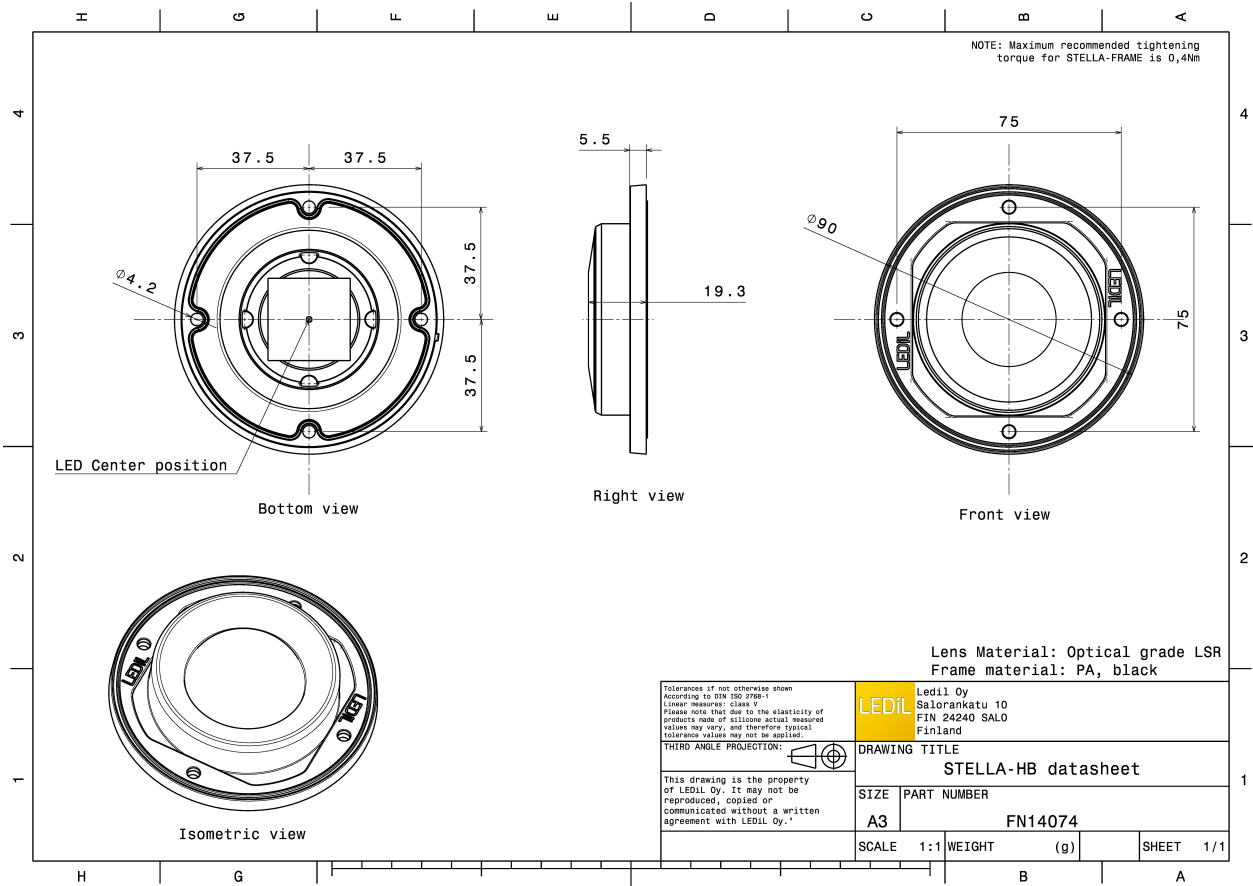

See also our general installation guide: www.ledil.com/installation_guide

OPTICAL RESULTS (MEASURED):

bridgelux

LED V18 Gen7
 FWHM / FWTM 80.0° / 101.0°
 Efficiency 93 %
 Peak intensity 0.6 cd/lm
 LEDs/each optic 1
 Light colour/type White
 Required components:

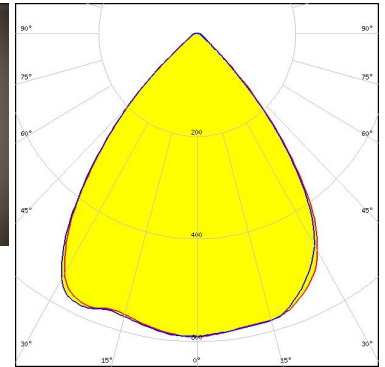
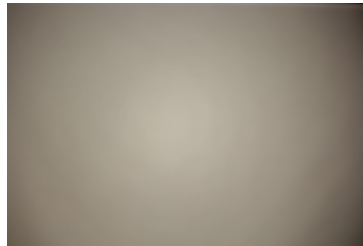

Light distribution files

bridgelux

LED V22 Gen7
 FWHM / FWTM 75.0° / 101.0°
 Efficiency 93 %
 Peak intensity 0.7 cd/lm
 LEDs/each optic 1
 Light colour/type White
 Required components:

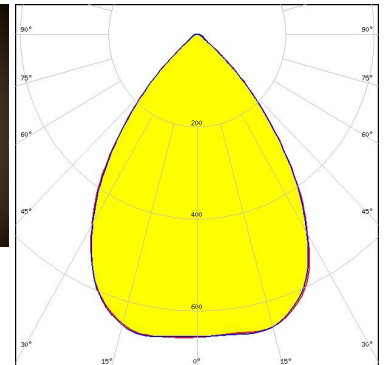
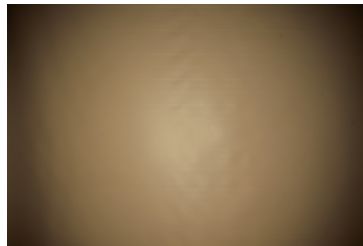

Light distribution files

bridgelux

LED VERO18
 FWHM / FWTM 75.0° / 96.0°
 Efficiency 93 %
 Peak intensity 0.7 cd/lm
 LEDs/each optic 1
 Light colour/type White
 Required components:

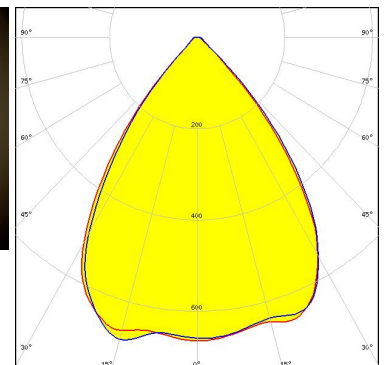
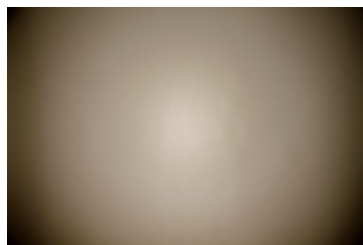

Light distribution files

OPTICAL RESULTS (MEASURED):



LED VERO29
FWHM / FWTM 69.0° / 104.0°
Efficiency 94 %
Peak intensity 0.7 cd/lm
LEDs/each optic 1
Light colour/type White
Required components:

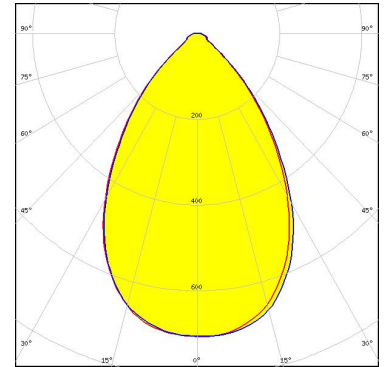

Light distribution files

CITIZEN

LED CLL05x/CLU05x
FWHM / FWTM 65.0° / 103.0°
Efficiency 94 %
Peak intensity 0.7 cd/lm
LEDs/each optic 1
Light colour/type White
Required components:
 Bender Wirth: 458 Typ L4

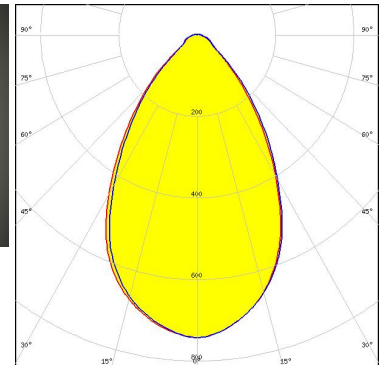
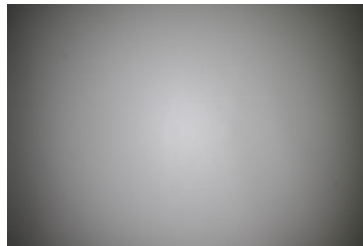

Light distribution files

CITIZEN

LED CLL05x/CLU05x
FWHM / FWTM 73.0° / 110.0°
Efficiency 93 %
Peak intensity 0.6 cd/lm
LEDs/each optic 1
Light colour/type White
Required components:

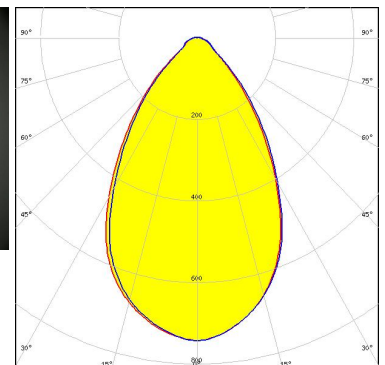
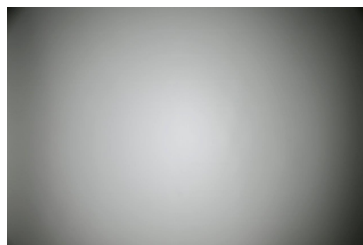

Light distribution files

OPTICAL RESULTS (MEASURED):

CITIZEN

LED CLU04x
 FWHM / FWTM 77.0° / 101.0°
 Efficiency 94 %
 Peak intensity 0.7 cd/lm
 LEDs/each optic 1
 Light colour/type White
 Required components:

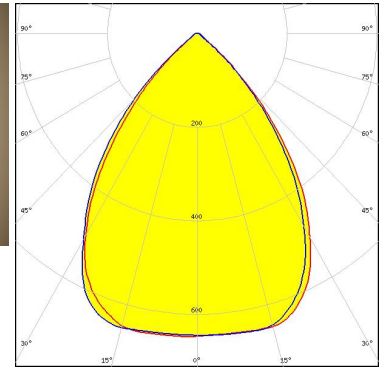
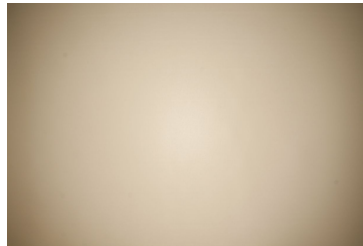

Light distribution files

CITIZEN

LED CLU04x
 FWHM / FWTM 68.0° / 94.0°
 Efficiency 93 %
 Peak intensity 0.8 cd/lm
 LEDs/each optic 1
 Light colour/type White
 Required components:
 Bender Wirth: 431 Typ L4

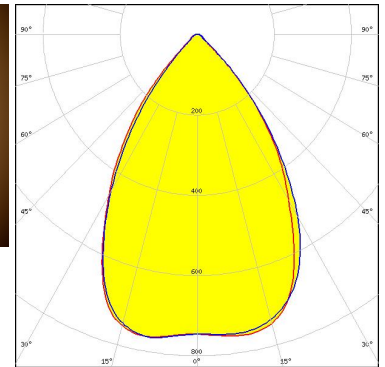
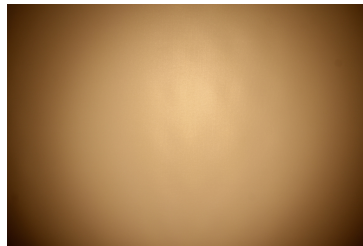

Light distribution files



LED CMA2550
 FWHM / FWTM 74.0° / 96.0°
 Efficiency 94 %
 Peak intensity 0.7 cd/lm
 LEDs/each optic 1
 Light colour/type White
 Required components:

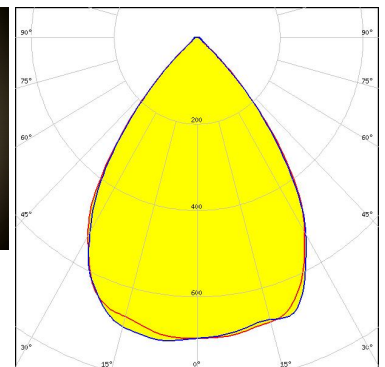
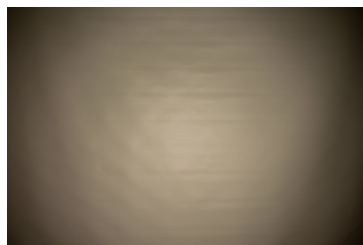

Light distribution files

OPTICAL RESULTS (MEASURED):



LED CMA3090
 FWHM / FWTM 67.0° / 96.0°
 Efficiency 96 %
 Peak intensity 0.8 cd/lm
 LEDs/each optic 1
 Light colour/type White
 Required components:

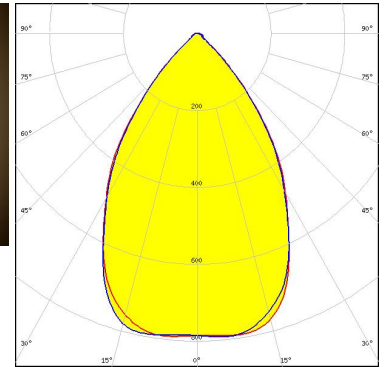

Light distribution files



LED CXA/B 1816 & CXA/B 1820 & CXA 1850
 FWHM / FWTM 87.0° / 104.0°
 Efficiency 93 %
 Peak intensity 0.6 cd/lm
 LEDs/each optic 1
 Light colour/type White
 Required components:

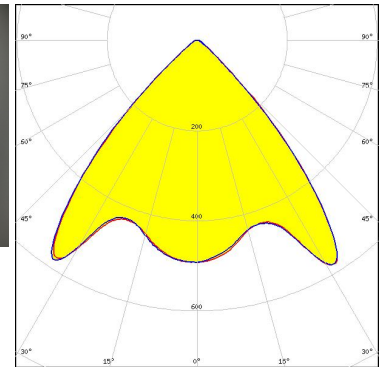
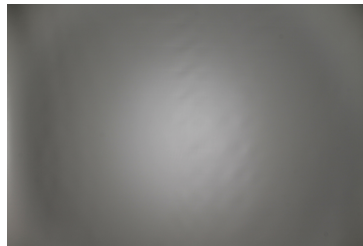

Light distribution files



LED CXA/B 25xx
 FWHM / FWTM 83.0° / 102.0°
 Efficiency 93 %
 Peak intensity 0.6 cd/lm
 LEDs/each optic 1
 Light colour/type White
 Required components:

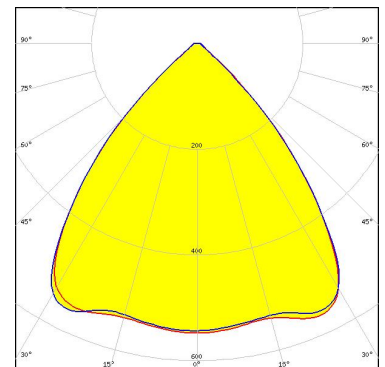

Light distribution files

OPTICAL RESULTS (MEASURED):



LED CXA/B 30xx
FWHM / FWTM 78.0° / 103.0°
Efficiency 93 %
Peak intensity 0.6 cd/lm
LEDs/each optic 1
Light colour/type White
Required components:

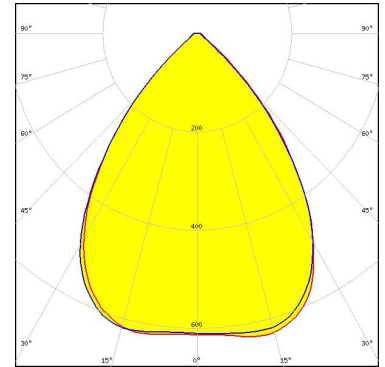

Light distribution files



LED CXA/B 3590
FWHM / FWTM 72.0° / 106.0°
Efficiency 93 %
Peak intensity 0.7 cd/lm
LEDs/each optic 1
Light colour/type White
Required components:

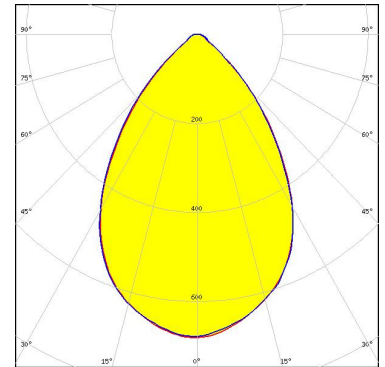

Light distribution files



LED LUXEON CoB 1211
FWHM / FWTM 71.0° / 93.0°
Efficiency 93 %
Peak intensity 0.7 cd/lm
LEDs/each optic 1
Light colour/type White
Required components:

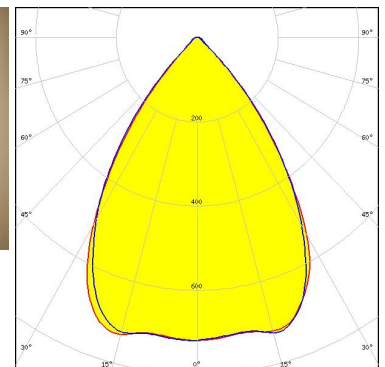
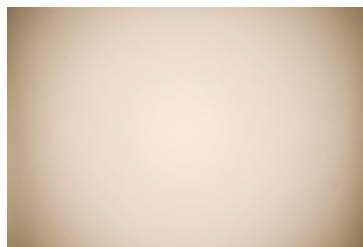

Light distribution files

OPTICAL RESULTS (MEASURED):



LED LUXEON CoB 1213/1216/1812
FWHM / FWTM 72.0° / 99.0°
Efficiency 94 %
Peak intensity 0.7 cd/lm
LEDs/each optic 1
Light colour/type White
Required components:

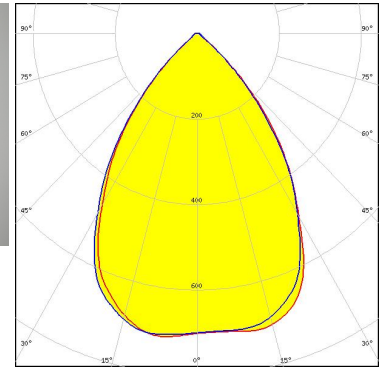

Light distribution files



LED LUXEON CoB 1321
FWHM / FWTM 71.0° / 108.0°
Efficiency 94 %
Peak intensity 0.7 cd/lm
LEDs/each optic 1
Light colour/type White
Required components:

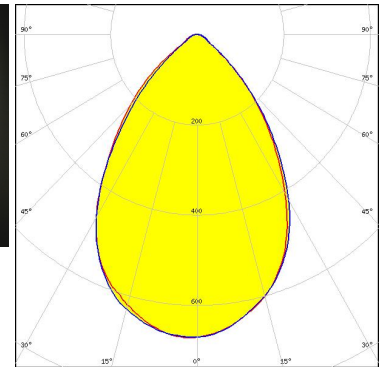
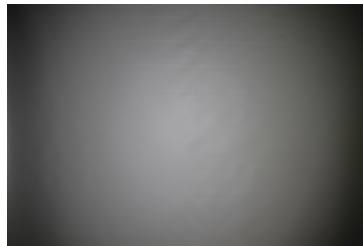

Light distribution files



LED LUXEON CoB 1825
FWHM / FWTM 72.0° / 111.0°
Efficiency 93 %
Peak intensity 0.6 cd/lm
LEDs/each optic 1
Light colour/type White
Required components:

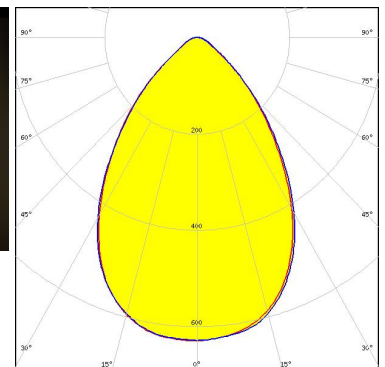
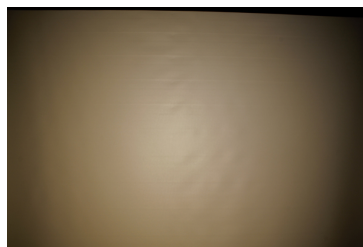

Light distribution files

OPTICAL RESULTS (MEASURED):



LED CxM-18 (21.5x21.5)
FWHM / FWTM 80.0° / 100.0°
Efficiency 93 %
Peak intensity 0.6 cd/lm
LEDs/each optic 1
Light colour/type White
Required components:

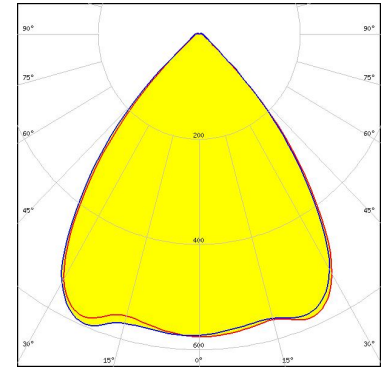

Light distribution files



LED CxM-22 (28x28)
FWHM / FWTM 73.0° / 100.0°
Efficiency 93 %
Peak intensity 0.7 cd/lm
LEDs/each optic 1
Light colour/type White
Required components:

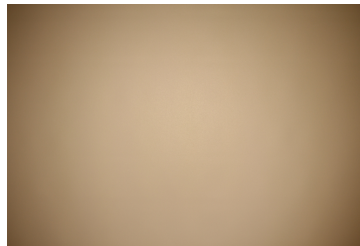

Light distribution files



LED COB H-Type
FWHM / FWTM 74.0° / 102.0°
Efficiency 94 %
Peak intensity 0.7 cd/lm
LEDs/each optic 1
Light colour/type White
Required components:

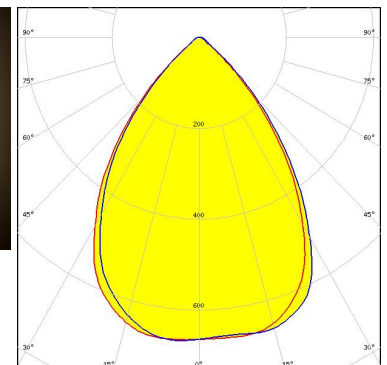
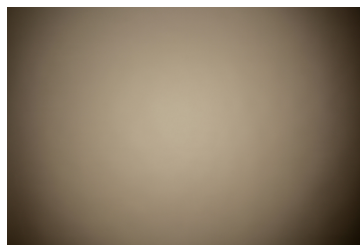

Light distribution files

OPTICAL RESULTS (MEASURED):



LED COB J-Type
FWHM / FWTM 84.0° / 102.0°
Efficiency 94 %
Peak intensity 0.6 cd/lm
LEDs/each optic 1
Light colour/type White
Required components:

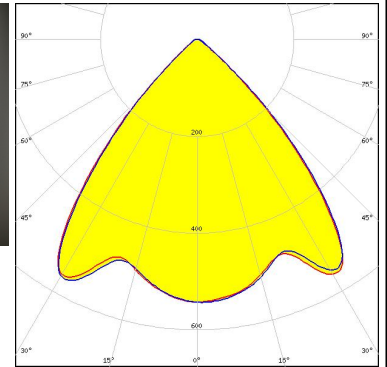
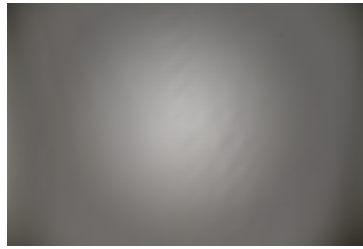

Light distribution files



LED Soleriq S19
FWHM / FWTM 84.0° / 101.0°
Efficiency 92 %
Peak intensity 0.6 cd/lm
LEDs/each optic 1
Light colour/type White
Required components:

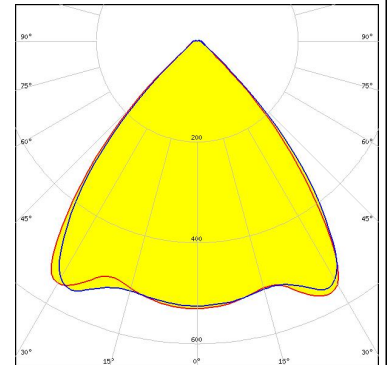

Light distribution files



LED Fortimo SLM L19 CoB
FWHM / FWTM 71.0° / 94.0°
Efficiency 94 %
Peak intensity 0.8 cd/lm
LEDs/each optic 1
Light colour/type White
Required components:
 Bender Wirth: 431 Typ L4

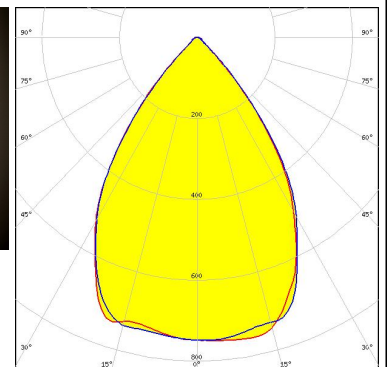
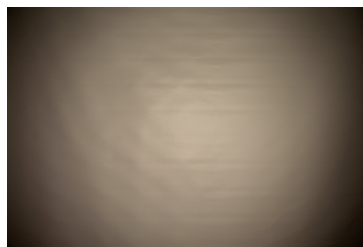

Light distribution files

OPTICAL RESULTS (MEASURED):

PHILIPS

LED Fortimo SLM L23 CoB
FWHM / FWTM 67.0° / 96.0°
Efficiency 94 %
Peak intensity 0.8 cd/lm
LEDs/each optic 1
Light colour/type White
Required components:
Bender Wirth: 431 Typ L4

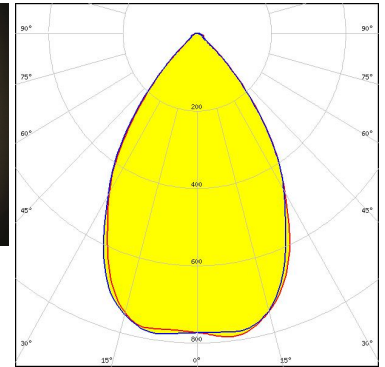

Light distribution files

SAMSUNG

LED LC016D / LC019D / LC026D / LC033D
FWHM / FWTM 83.0° / 101.0°
Efficiency 93 %
Peak intensity 0.6 cd/lm
LEDs/each optic 1
Light colour/type White
Required components:

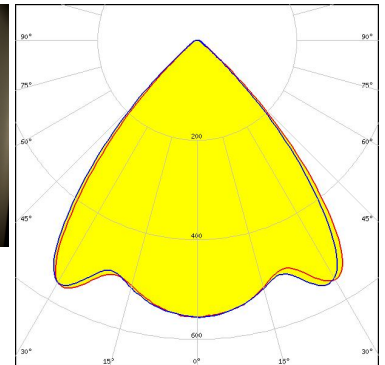
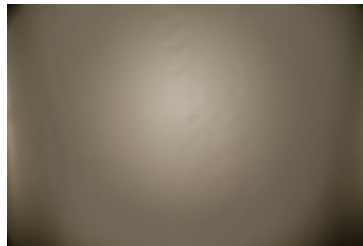

Light distribution files

SAMSUNG

LED LC040D / LC060D / LC080D
FWHM / FWTM 76.0° / 102.0°
Efficiency 93 %
Peak intensity 0.7 cd/lm
LEDs/each optic 1
Light colour/type White
Required components:

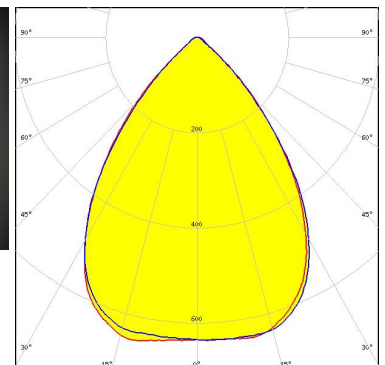
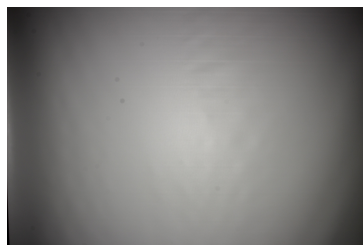

Light distribution files

OPTICAL RESULTS (MEASURED):

SAMSUNG

LED LC040D / LC060D / LC080D
FWHM / FWTM 77.0° / 104.0°
Efficiency 93 %
Peak intensity 0.6 cd/lm
LEDs/each optic 1
Light colour/type White
Required components:

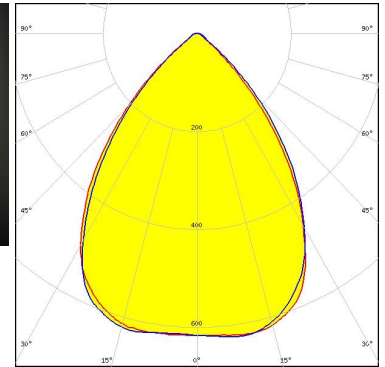
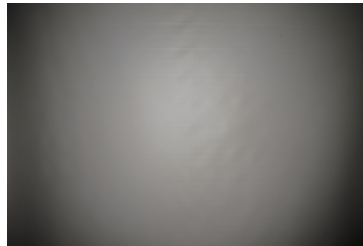

Light distribution files



LED MJT COB LES 33
FWHM / FWTM 68.0° / 106.0°
Efficiency 93 %
Peak intensity 0.7 cd/lm
LEDs/each optic 1
Light colour/type White
Required components:
Bender Wirth: 458 Typ L4

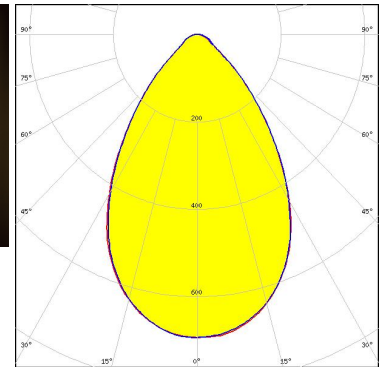
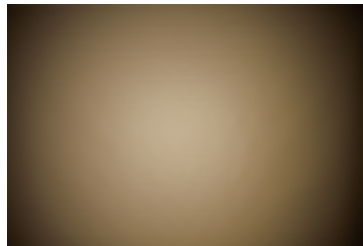

Light distribution files

OPTICAL RESULTS (SIMULATED):



LED V13 Gen 8-9
FWHM / FWTM 78.0° / 94.0°
Efficiency 91 %
Peak intensity 0.7 cd/lm
LEDs/each optic 1
Light colour/type White
Required components:

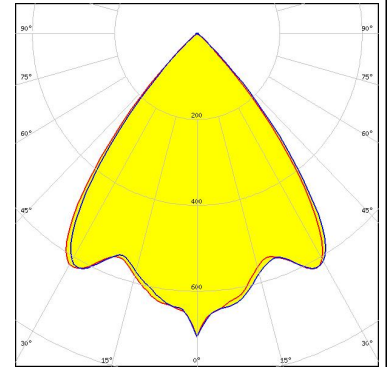

Light distribution files



LED V18 Gen 8-9
FWHM / FWTM 76.0° / 96.0°
Efficiency 90 %
Peak intensity 0.7 cd/lm
LEDs/each optic 1
Light colour/type White
Required components:

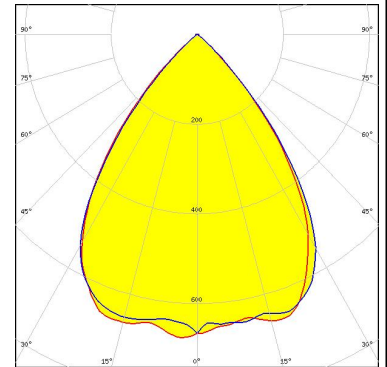

Bender Wirth: 462 Typ L4

Light distribution files



LED V22 Gen 8-9
FWHM / FWTM 72.0° / 97.0°
Efficiency 90 %
Peak intensity 0.7 cd/lm
LEDs/each optic 1
Light colour/type White
Required components:

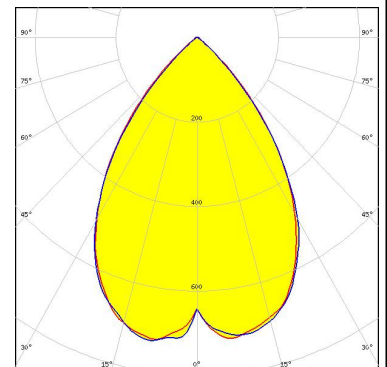

Bender Wirth: 431 Typ L4

Light distribution files

OPTICAL RESULTS (SIMULATED):



LED V22 Gen7
FWHM / FWTM 68.0° / 92.0°
Efficiency 94 %
Peak intensity 0.9 cd/lm
LEDs/each optic 1
Light colour/type White
Required components:

Bender Wirth: 431 Typ L4

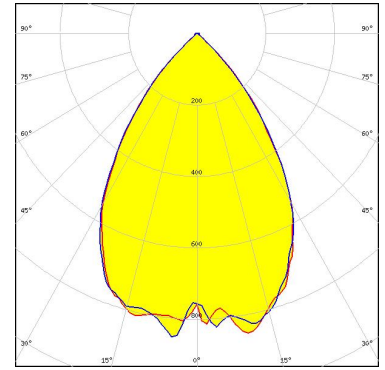

Light distribution files



LED Vesta TW 13mm (18W) DP
FWHM / FWTM 78.0° / 93.0°
Efficiency 91 %
Peak intensity 0.7 cd/lm
LEDs/each optic 1
Light colour/type Tunable White
Required components:

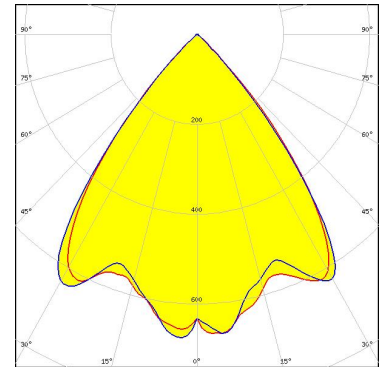

Light distribution files



LED Vesta TW 18mm (31W) DP
FWHM / FWTM 75.0° / 96.0°
Efficiency 91 %
Peak intensity 0.7 cd/lm
LEDs/each optic 1
Light colour/type Tunable White
Required components:

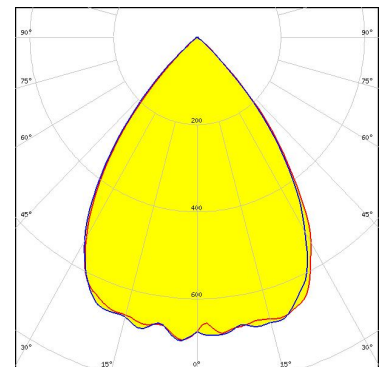

Light distribution files

OPTICAL RESULTS (SIMULATED):



LED Vesta TW 22mm DP
 FWHM / FWTM 72.0° / 97.0°
 Efficiency 91 %
 Peak intensity 0.7 cd/lm
 LEDs/each optic 1
 Light colour/type Tunable White
 Required components:

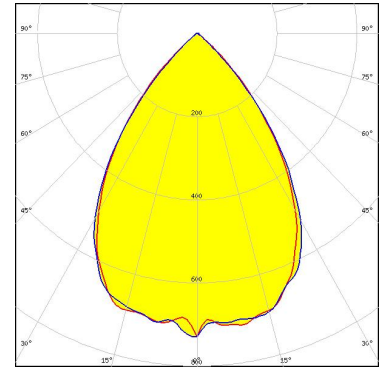

Light distribution files

CITIZEN

LED CLU03x
 FWHM / FWTM 76.0° / 93.0°
 Efficiency 96 %
 Peak intensity 0.7 cd/lm
 LEDs/each optic 1
 Light colour/type White
 Required components:

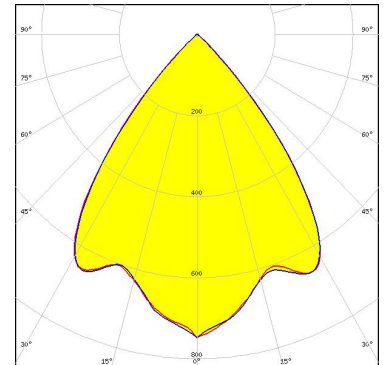

Light distribution files



LED CMA1303
 FWHM / FWTM 106.0° / 177.0°
 Efficiency 75 %
 Peak intensity 0.3 cd/lm
 LEDs/each optic 1
 Light colour/type White
 Required components:

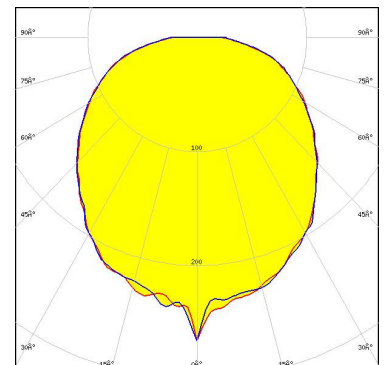

Light distribution files

OPTICAL RESULTS (SIMULATED):



LED CMA3090
FWHM / FWTM 73.0° / 100.0°
Efficiency 94 %
Peak intensity 0.8 cd/lm
LEDs/each optic 1
Light colour/type White
Required components:

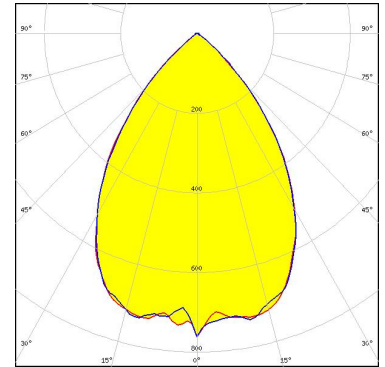

Light distribution files



LED CMT28xx
FWHM / FWTM 73.0° / 98.0°
Efficiency 91 %
Peak intensity 0.7 cd/lm
LEDs/each optic 1
Light colour/type White
Required components:

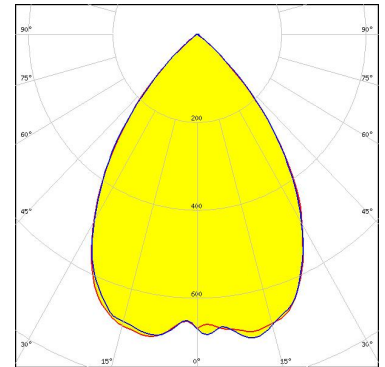

Light distribution files



LED CXM-32
FWHM / FWTM 68.0° / 104.0°
Efficiency 96 %
Peak intensity 0.7 cd/lm
LEDs/each optic 1
Light colour/type White
Required components:

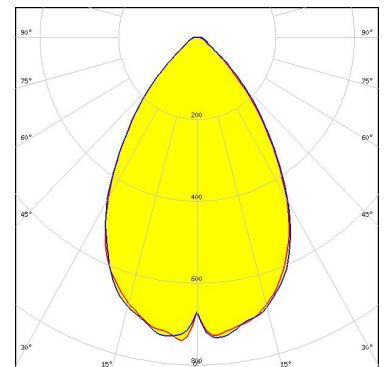

Light distribution files

OPTICAL RESULTS (SIMULATED):

PHILIPS

LED	Fortimo SLM L13 CoB
FWHM / FWTM	78.0° / 92.0°
Efficiency	91 %
Peak intensity	0.7 cd/lm
LEDs/each optic	1
Light colour/type	White
Required components:	

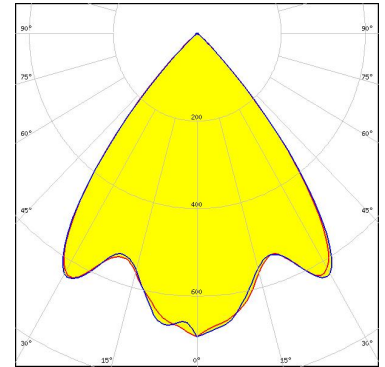

Light distribution files

TRIDONIC

LED	SLE 13mm 3000lm xxx R ADV8
FWHM / FWTM	82.0° / 96.0°
Efficiency	91 %
Peak intensity	0.6 cd/lm
LEDs/each optic	1
Light colour/type	White
Required components:	

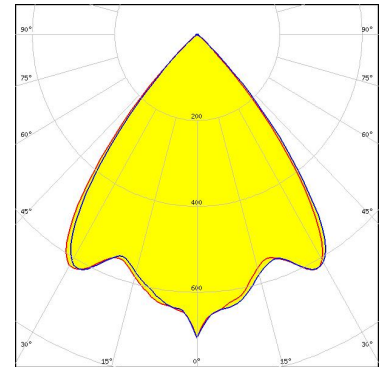

Light distribution files

TRIDONIC

LED	SLE 17mm 5000lm xxx R ADV8
FWHM / FWTM	78.0° / 98.0°
Efficiency	91 %
Peak intensity	0.6 cd/lm
LEDs/each optic	1
Light colour/type	White
Required components:	

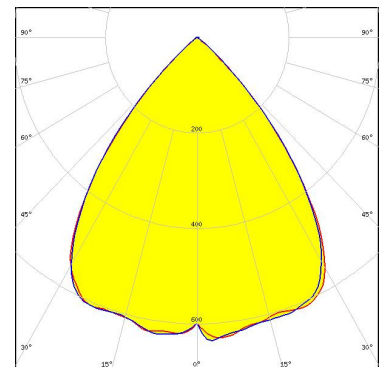

Bender Wirth: 466 Typ L4

Light distribution files

OPTICAL RESULTS (SIMULATED):

TRIDONIC

LED	SLE 21mm 6000lm xxx R ADV8
FWHM / FWTM	73.0° / 99.0°
Efficiency	91 %
Peak intensity	0.7 cd/lm
LEDs/each optic	1
Light colour/type	White
Required components:	

Bender Wirth: 466 Typ L4

Light distribution files

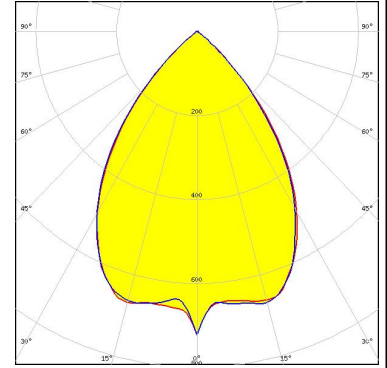

GENERAL INFORMATION:

NOTE: The typical beam angle will be changed by different color, chip size and chip position tolerance. The typical total beam angle is the full angle measured where the luminous intensity is half of the peak value.

Due to use of high power COB's with this product, special attention to proper thermal design is highly recommended. LEDiL has no liability for direct, indirect or consecutive damages arising from the LEDiL products being used outside of the recommended temperature range.

MATERIALS:

As part of our continuous research and improvement processes, and to ensure the best possible quality and availability of our products, LEDiL reserves the right to change material grades without notice.

PRODUCT DATA USER AGREEMENT AND DISCLAIMER:

The measured data in the provided downloadable LEDiL Product Datasheets and Mechanical 2D-Drawings is rounded and provided as reference for planning. LEDiL Oy's optical specifications have been verified by conducting performance testing of the products in accordance with the company's quality system. The reported data are averaged results of multiple measurements with typical variation. LEDiL Oy reserves the right to without prior notification make changes and improvements to its products.

LEDiL Oy assumes neither warranty, nor guarantee nor any other liability of any kind for the contents and correctness of the provided data. The provided data has been generated with highest diligence but the provided data may in reality not represent the complete possible variation range of all intrinsic parameters. Therefore, in certain cases a deviation from the provided data could occur.

LEDiL Oy reserves the right to undertake technical changes of its products without further notification which could lead to changes in the provided data. LEDiL Oy assumes no liability of any kind for the possible deviation from any provided data or any other damage resulting from the usage of the provided data.

The user agrees to this disclaimer and user agreement with the download or usage of the provided files.

LEDiL Oy

Joensuunkatu 7
FI-24100 SALO
Finland

LEDiL Inc.

228 West Page Street
Suite D
Sycamore IL 60178
USA

Ledil Optics Technology (Shenzhen) Co., Ltd.

405 , Block B
Casic Motor Building
Shenzhen 518057
P.R.CHINA

Local sales and technical support

[www.ledil.com/
where_to_buy](http://www.ledil.com/where_to_buy)

Shipping locations

Poznan, Poland
Hong Kong, China

Distribution Partners

[www.ledil.com/
where_to_buy](http://www.ledil.com/where_to_buy)

Looking for pricing, stock, or lifecycle information?

Click below to explore more details on WIN SOURCE:

 [View FN14074_STELLA-HB on WIN SOURCE](#)

 [Ledil Information](#)

Optimize Your Supply Chain with WIN SOURCE Solutions

-  Global Sourcing Solution
-  Obsolete Management
-  Cost Control Management
-  Shortage Management
-  Alternative Solution
-  Excess Inventory Management