

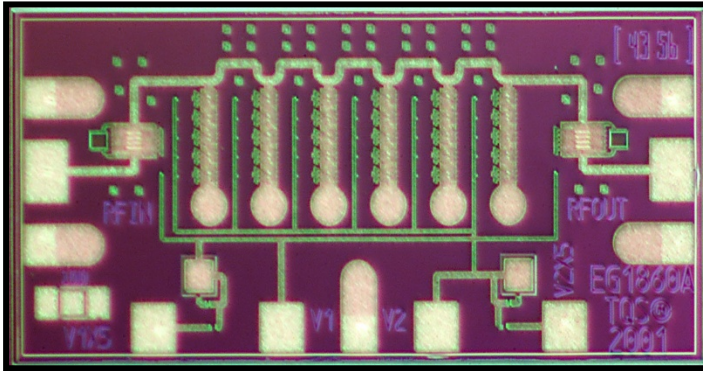

# 50 GHz Wideband Analog Attenuator

# TGL4203



Chip Dimensions 1.7mm x 0.8 mm x 0.1mm

## Key Features and Performance

- 0.25um 3MI MMW pHEMT
- Broadband Response DC to > 50 GHz
- 2dB typical Insertion Loss
- 17dB Variable Attenuation Range
- 15dB typical Return Loss
- Bias: -1V to 0V

## Primary Applications

- Point to Point Radio
- Fiber Optic
- Wideband Military & Space

## Typical Electrical Characteristics

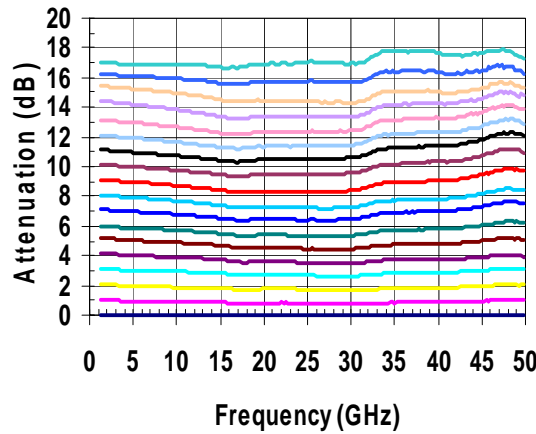
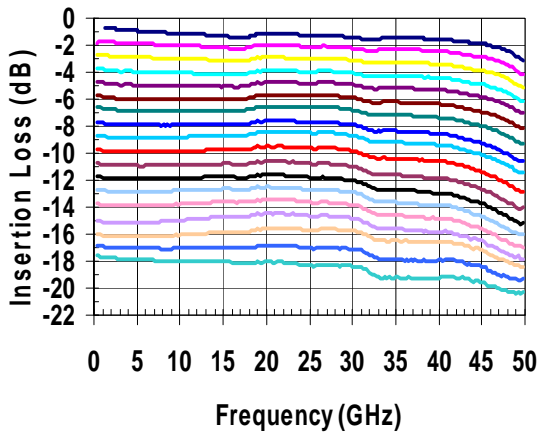

	V1 / V2
REF	0.000 / -1.000
1dB	-0.549 / -0.838
2dB	-0.606 / -0.752
3dB	-0.635 / -0.708
4dB	-0.659 / -0.680
5dB	-0.673 / -0.651
6dB	-0.679 / -0.626
7dB	-0.689 / -0.597
8dB	-0.705 / -0.578
9dB	-0.713 / -0.549
10dB	-0.719 / -0.518
11dB	-0.730 / -0.489
12dB	-0.744 / -0.461
13dB	-0.762 / -0.430
14dB	-0.794 / -0.392
15dB	-0.800 / -0.327
16dB	-0.851 / -0.267
17dB	-0.900 / -0.203

Bias Voltages Optimized for Flatness of Attenuation with respect to Reference over Frequency

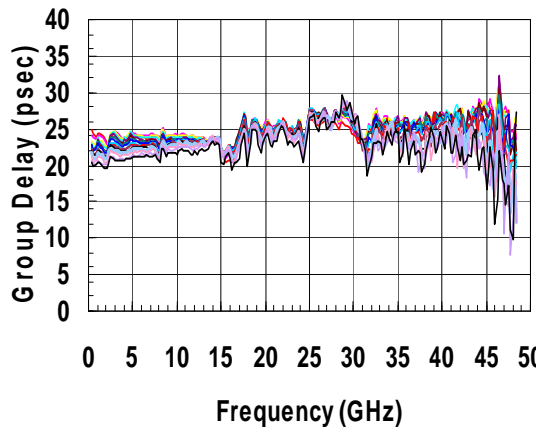
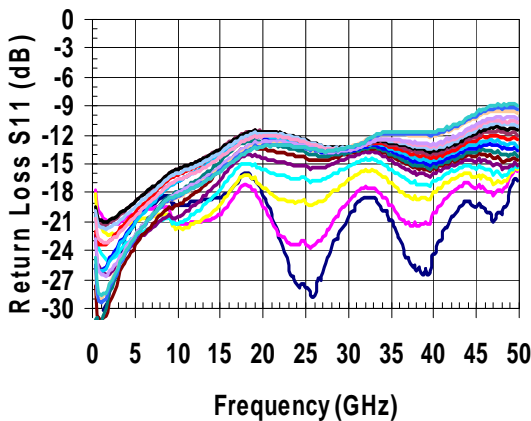

**TABLE I**  
**MAXIMUM RATINGS 1/**

SYMBOL	PARAMETER	VALUE	NOTES
	Attenuation Control Voltage Range	-5 to +0.5 V	
I <sub>G1</sub>	Gate 1 Supply Current	2.2 mA	
I <sub>G2</sub>	Gate 2 Supply Current	19.8 mA	
P <sub>IN</sub>	Input Continuous Wave Power	24 dBm	
P <sub>D</sub>	Power Dissipation	TBD	
T <sub>CH</sub>	Operating Channel Temperature	200 °C	<u>2/</u>
T <sub>M</sub>	Mounting Temperature (30 Seconds)	320 °C	
T <sub>STG</sub>	Storage Temperature	-65 to 150 °C	

1/ These ratings represent the maximum operable values for this device.

2/ Junction operating temperature will directly affect the device median time to failure (T<sub>M</sub>). For maximum life, it is recommended that junction temperatures be maintained at the lowest possible levels.

**TABLE II**  
**ELECTRICAL CHARACTERISTICS**

(T<sub>a</sub> = 25 °C Nominal)

PARAMETER		TEST CONDITIONS	MIN	TYP	MAX	UNIT
	Attenuation Control Voltage	DC ~ 50 GHz	-1.3	-1 to 0	0	V
IL	Insertion Loss	DC – 20 GHz		1.4	2	dB
		20 – 40 GHz		1.9	2.5	
		40 – 50 GHz		2.5	4	
	Maximum Attenuation (max – min) Insertion Loss	DC – 20 GHz	13	15	17	dB
		20 – 50 GHz	10	15	20	
IRL	Input Return Loss	DC ~ 50 GHz		15		dB
ORL	Output Return Loss	DC ~ 50 GHz		15		dB
Pin1dB	Input Power @ 1dB Atten. Change	5 to 25 GHz		*		dBm
	Group Delay Variation	DC ~ 50 GHz		+/-5		psec
	Max. Insertion Loss Ripple (peak to peak)	DC ~ 50 GHz		0.5		dB

\* Pin1dB varies depending on Attenuation State and frequency. See graphs on page 3 for details

**Typical Pin1dB vs Attenuation**

Ta = 25 °C Nominal

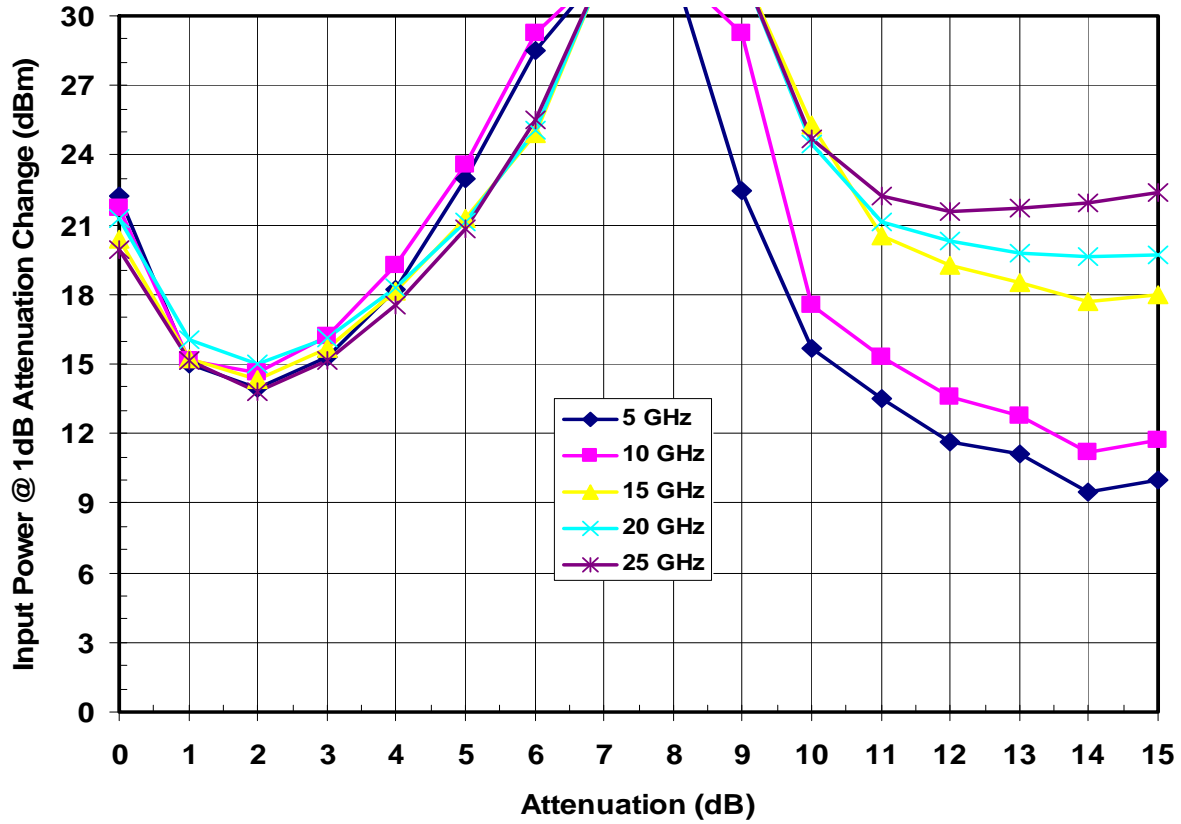

**Typical Attenuator Input TOI vs. Attenuation**

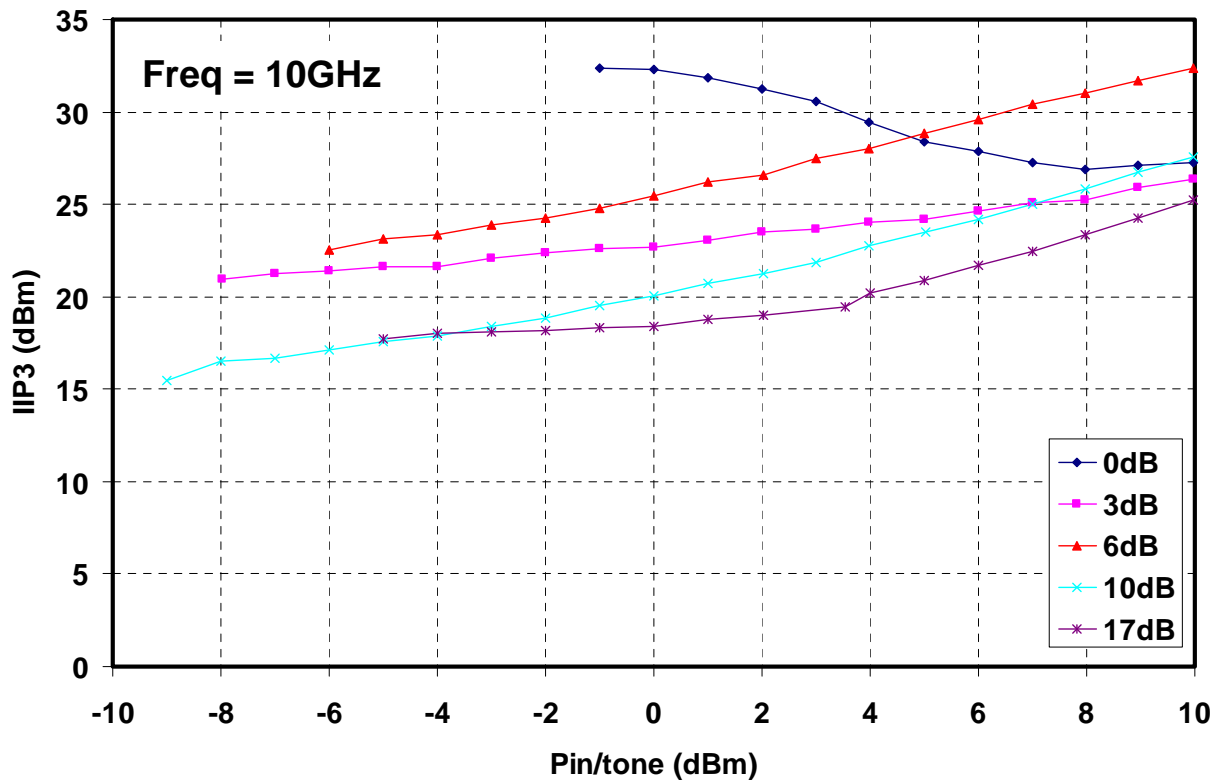
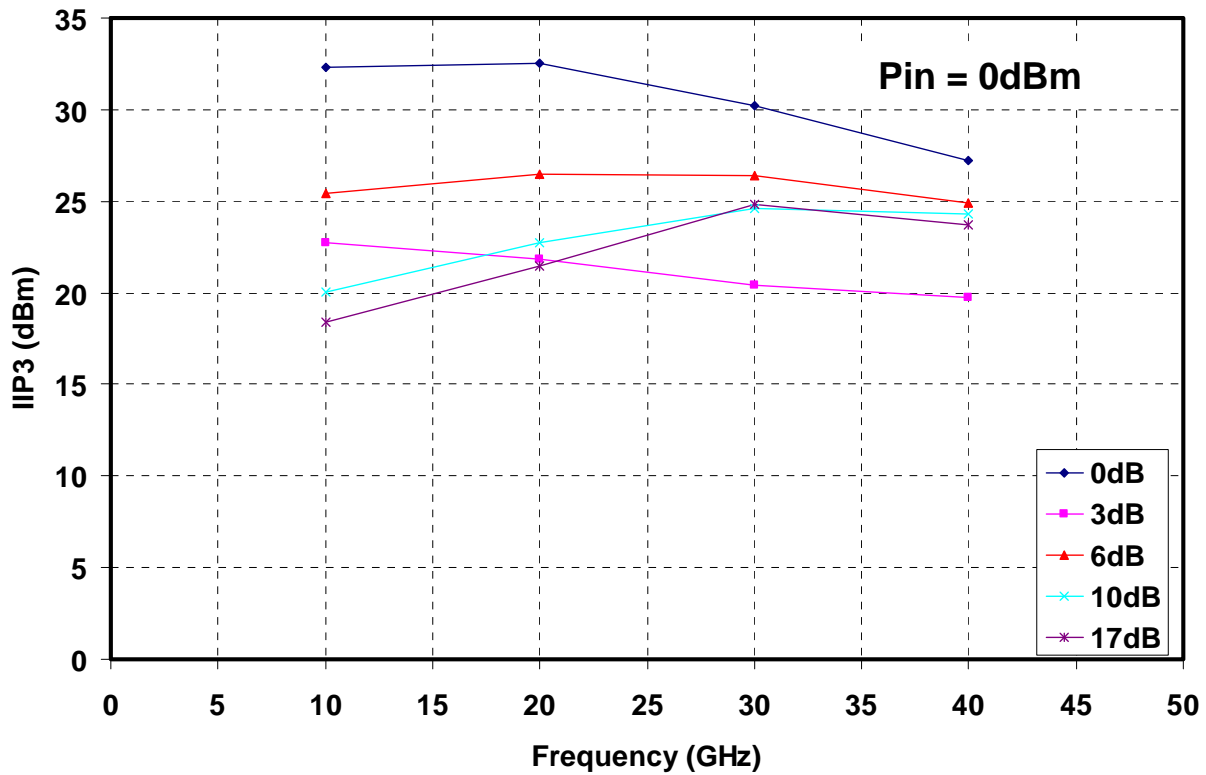

**Typical Attenuator Input TOI vs. Attenuation**

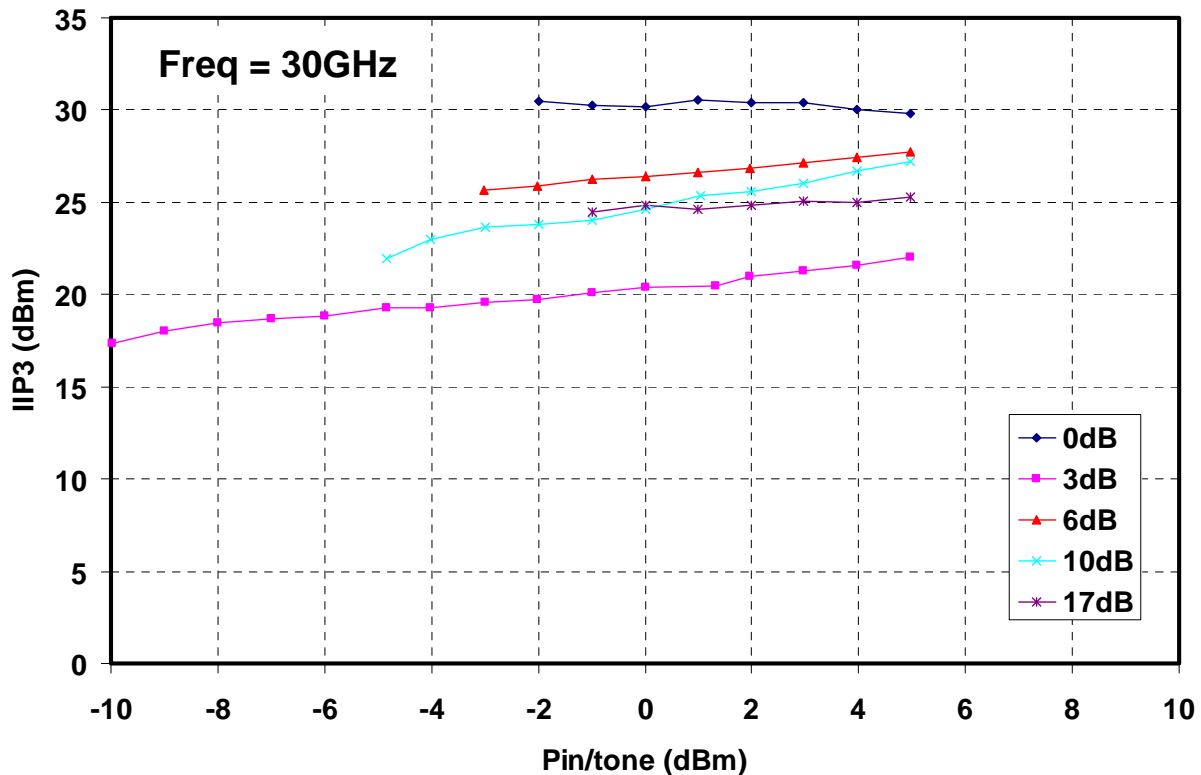
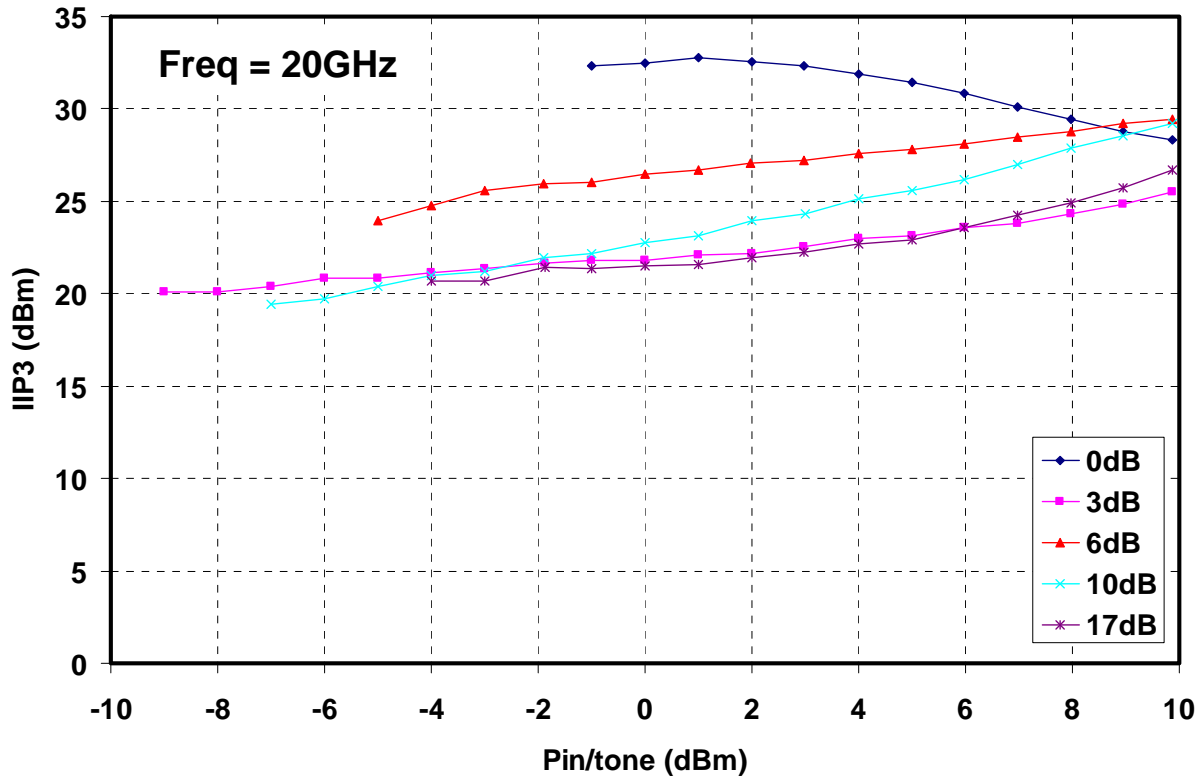

**Typical Measurement Over Temperature**

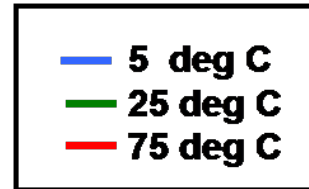
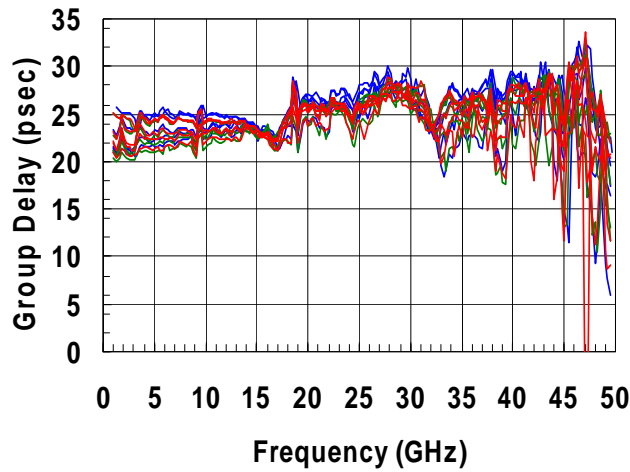
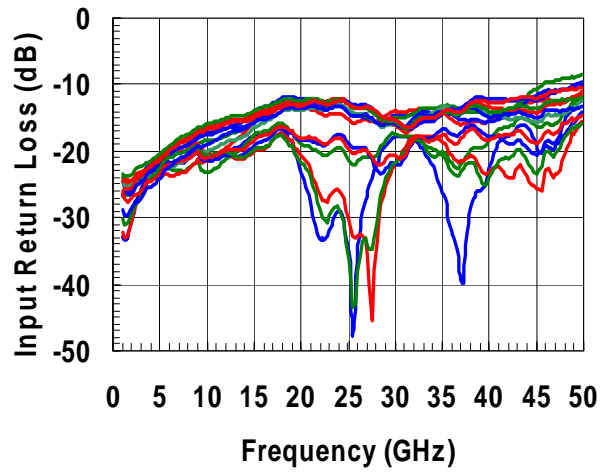
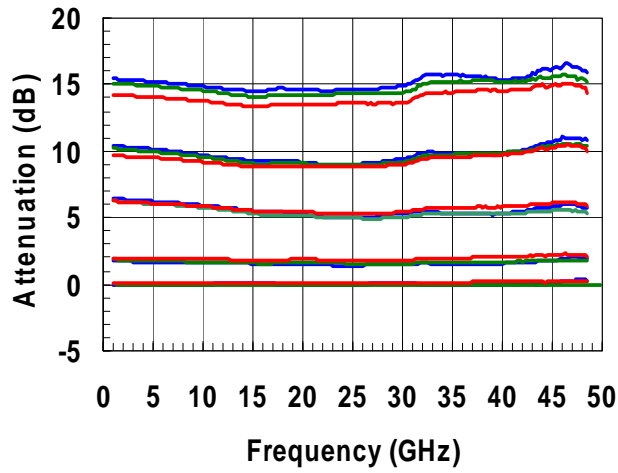

**Mechanical Drawing**

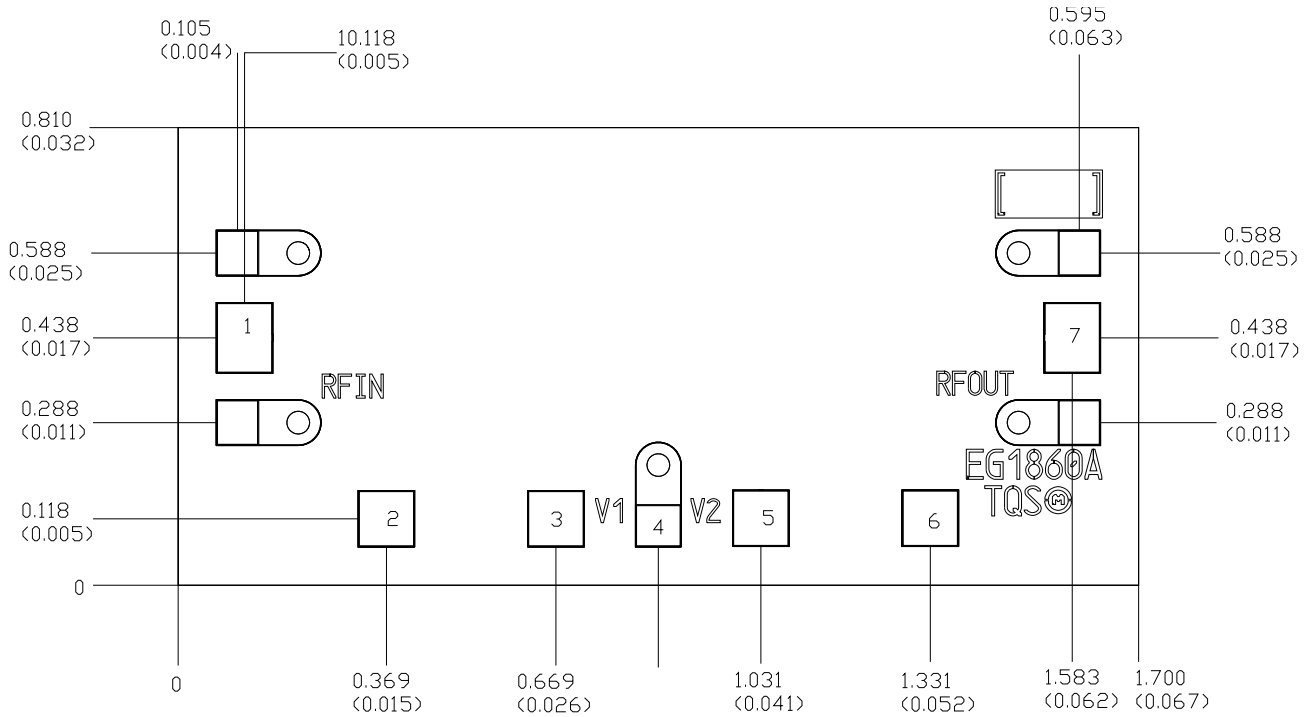

Units: millimeters (inches)  
 Thickness: 0.100 (0.004)  
 Chip edge to bond pad dimensions are shown to center of bond pad  
 Chip size tolerance: +/- 0.051 (0.002)  
 RF GND is back side of MMIC

Bond pad #1	(RF In)	0.100 x 0.125	(0.004 x 0.005)
Bond pad #2	(NC)	0.100 x 0.100	(0.004 x 0.004)
Bond pad #3	(VG1)	0.100 x 0.100	(0.004 x 0.004)
Bond pad #4	(DC GND)	0.081 x 0.075	(0.003 x 0.003)
Bond pad #5	(VG2)	0.100 x 0.100	(0.004 x 0.004)
Bond pad #6	(NC)	0.100 x 0.100	(0.004 x 0.004)
Bond pad #7	(RF Out)	0.100 x 0.125	(0.004 x 0.005)

**GaAs MMIC devices are susceptible to damage from Electrostatic Discharge. Proper precautions should be observed during handling, assembly and test.**

**DC Schematic**

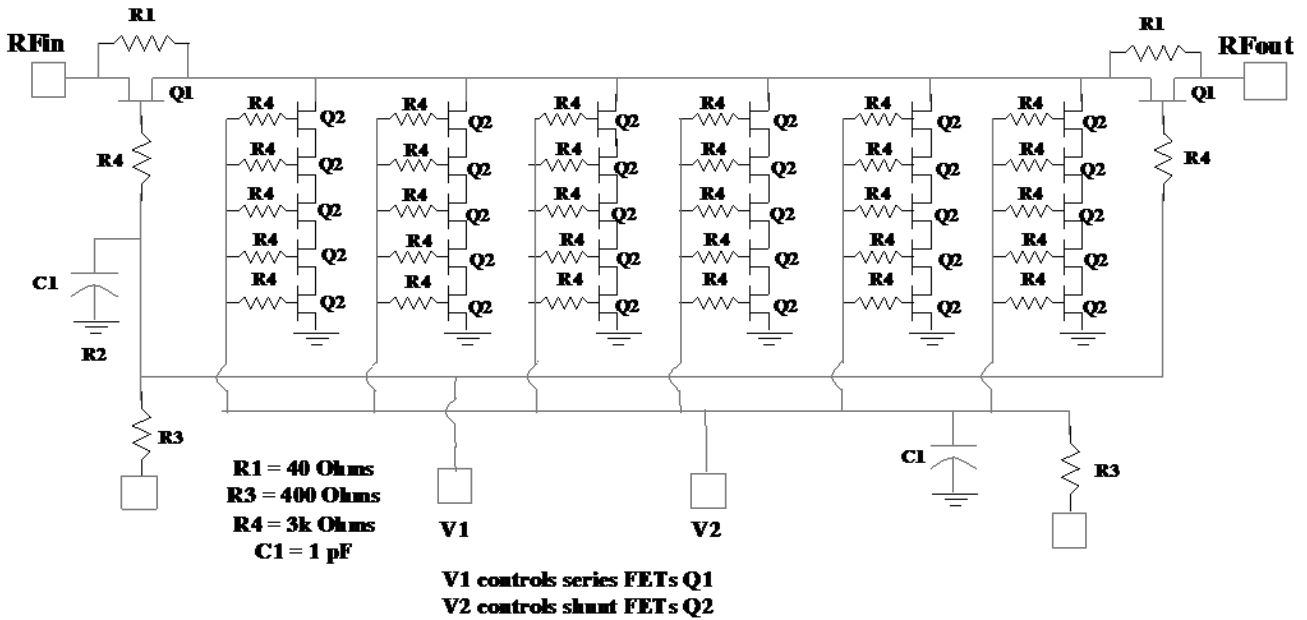

*GaAs MMIC devices are susceptible to damage from Electrostatic Discharge. Proper precautions should be observed during handling, assembly and test.*

### Chip Assembly Diagram

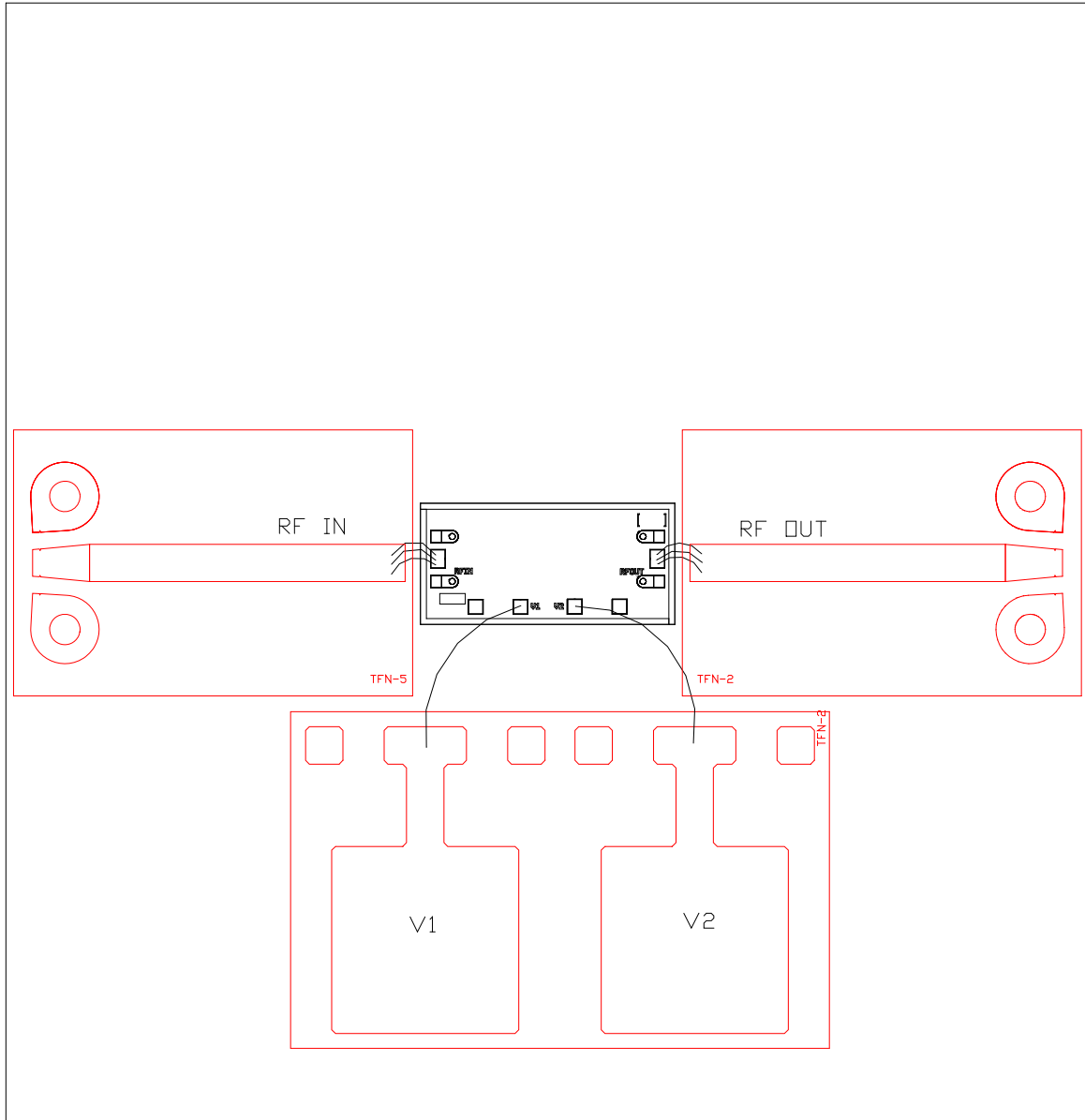

***RF Ports must be DC Blocked***

***GaAs MMIC devices are susceptible to damage from Electrostatic Discharge. Proper precautions should be observed during handling, assembly and test.***

## Assembly Process Notes

Reflow process assembly notes:

- Use AuSn (80/20) solder with limited exposure to temperatures at or above 300°C (30 seconds max).
- An alloy station or conveyor furnace with reducing atmosphere should be used.
- No fluxes should be utilized.
- Coefficient of thermal expansion matching is critical for long-term reliability.
- Devices must be stored in a dry nitrogen atmosphere.

Component placement and adhesive attachment assembly notes:

- Vacuum pencils and/or vacuum collets are the preferred method of pick up.
- Air bridges must be avoided during placement.
- The force impact is critical during auto placement.
- Organic attachment can be used in low-power applications.
- Curing should be done in a convection oven; proper exhaust is a safety concern.
- Microwave or radiant curing should not be used because of differential heating.
- Coefficient of thermal expansion matching is critical.

Interconnect process assembly notes:

- Thermosonic ball bonding is the preferred interconnect technique.
- Force, time, and ultrasonics are critical parameters.
- Aluminum wire should not be used.
- Discrete FET devices with small pad sizes should be bonded with 0.0007-inch wire.
- Maximum stage temperature is 200°C.

***GaAs MMIC devices are susceptible to damage from Electrostatic Discharge. Proper precautions should be observed during handling, assembly and test.***

## Looking for pricing, stock, or lifecycle information?

Click below to explore more details on WIN SOURCE:

 [View TGL4203 on WIN SOURCE](#)

 [Qorvo US Inc. Information](#)

## Optimize Your Supply Chain with WIN SOURCE Solutions

-  Global Sourcing Solution
-  Obsolete Management
-  Cost Control Management
-  Shortage Management
-  Alternative Solution
-  Excess Inventory Management