



**THE DATASHEET OF  
282T33L502A26A2**



# Series 282

## 16mm Precision Rotary Potentiometer

- Conductive Plastic Element
- Extended Rotational Life (2 Million Cycles)
- Precision Linearity ( $\pm 2\%$ )
- Ingress Protection (IP65 & IP67 Options)
- Wide Operating Temperature Range
- Shaft and Bushing Length Options
- Terminal Options
- Continuous Rotation Available



### Description

The 282 Series robust construction provides the user with a long life, highly reliable precision product in a sealed housing which meets up IP standards. Options include various terminal configurations, shaft and bushing lengths, shaft styles, resistance values and tolerances, and various rotation angles to meet design requirements.

### Ordering Information

Series	Terminal Styles	Bushing Length "A"	Shaft Length "L"	Shaft Trim	Resistance Code	Resistance Tolerance	Linearity	IP Rating	Rotational Angle	A/R Lug Options																																																																									
282	T	A	A	R	103	A	2	5	B	1																																																																									
<table border="1"> <thead> <tr> <th>Code</th> <th>Spec</th> </tr> </thead> <tbody> <tr> <td>T</td> <td>Solder lug</td> </tr> <tr> <td>S</td> <td>Solder lug formed to rear</td> </tr> <tr> <td>U</td> <td>PC formed to front</td> </tr> </tbody> </table>		Code	Spec	T	Solder lug	S	Solder lug formed to rear	U	PC formed to front	<table border="1"> <thead> <tr> <th>Code</th> <th>Spec.</th> </tr> </thead> <tbody> <tr> <td>1</td> <td>.625" (15.8mm)</td> </tr> <tr> <td>2</td> <td>.750" (18.4mm)</td> </tr> <tr> <td>3</td> <td>.875" (22.2mm)</td> </tr> <tr> <td>4</td> <td>1.000" (25.4mm)</td> </tr> <tr> <td>5</td> <td>1.125" (28.5mm)</td> </tr> <tr> <td colspan="2"><i>Diameter: 1/4"</i></td> </tr> <tr> <td colspan="2"><i>Length increment: 1/8"</i></td> </tr> <tr> <td>A</td> <td>10mm (.393")</td> </tr> <tr> <td>B</td> <td>15mm (.590")</td> </tr> <tr> <td>C</td> <td>20mm (.787")</td> </tr> <tr> <td>D</td> <td>25mm (.984")</td> </tr> <tr> <td>E</td> <td>30mm (1.181")</td> </tr> <tr> <td colspan="2"><i>Diameter: 6mm</i></td> </tr> <tr> <td colspan="2"><i>Length increment: 5mm</i></td> </tr> </tbody> </table>		Code	Spec.	1	.625" (15.8mm)	2	.750" (18.4mm)	3	.875" (22.2mm)	4	1.000" (25.4mm)	5	1.125" (28.5mm)	<i>Diameter: 1/4"</i>		<i>Length increment: 1/8"</i>		A	10mm (.393")	B	15mm (.590")	C	20mm (.787")	D	25mm (.984")	E	30mm (1.181")	<i>Diameter: 6mm</i>		<i>Length increment: 5mm</i>		<table border="1"> <thead> <tr> <th>Code</th> <th>Resistance</th> </tr> </thead> <tbody> <tr> <td>102</td> <td>1 k<math>\Omega</math></td> </tr> <tr> <td>252</td> <td>2.5 k<math>\Omega</math></td> </tr> <tr> <td>502</td> <td>5 k<math>\Omega</math></td> </tr> <tr> <td>103</td> <td>10 k<math>\Omega</math></td> </tr> <tr> <td>503</td> <td>50 k<math>\Omega</math></td> </tr> <tr> <td>104</td> <td>100 k<math>\Omega</math></td> </tr> <tr> <td>504</td> <td>500 k<math>\Omega</math></td> </tr> </tbody> </table>		Code	Resistance	102	1 k $\Omega$	252	2.5 k $\Omega$	502	5 k $\Omega$	103	10 k $\Omega$	503	50 k $\Omega$	104	100 k $\Omega$	504	500 k $\Omega$	<table border="1"> <thead> <tr> <th>Code</th> <th>Spec.</th> </tr> </thead> <tbody> <tr> <td>5</td> <td>IP54</td> </tr> <tr> <td>6</td> <td>IP67</td> </tr> </tbody> </table>		Code	Spec.	5	IP54	6	IP67	<table border="1"> <thead> <tr> <th>Code</th> <th>Spec.</th> </tr> </thead> <tbody> <tr> <td>2</td> <td><math>\pm 2\%</math></td> </tr> </tbody> </table>		Code	Spec.	2	$\pm 2\%$	<table border="1"> <thead> <tr> <th>Code</th> <th>Spec.</th> </tr> </thead> <tbody> <tr> <td>1</td> <td>Left side (10mm)</td> </tr> <tr> <td>2</td> <td>Left side (8mm)</td> </tr> <tr> <td>3</td> <td>No lug</td> </tr> </tbody> </table>		Code	Spec.	1	Left side (10mm)	2	Left side (8mm)	3	No lug
Code	Spec																																																																																		
T	Solder lug																																																																																		
S	Solder lug formed to rear																																																																																		
U	PC formed to front																																																																																		
Code	Spec.																																																																																		
1	.625" (15.8mm)																																																																																		
2	.750" (18.4mm)																																																																																		
3	.875" (22.2mm)																																																																																		
4	1.000" (25.4mm)																																																																																		
5	1.125" (28.5mm)																																																																																		
<i>Diameter: 1/4"</i>																																																																																			
<i>Length increment: 1/8"</i>																																																																																			
A	10mm (.393")																																																																																		
B	15mm (.590")																																																																																		
C	20mm (.787")																																																																																		
D	25mm (.984")																																																																																		
E	30mm (1.181")																																																																																		
<i>Diameter: 6mm</i>																																																																																			
<i>Length increment: 5mm</i>																																																																																			
Code	Resistance																																																																																		
102	1 k $\Omega$																																																																																		
252	2.5 k $\Omega$																																																																																		
502	5 k $\Omega$																																																																																		
103	10 k $\Omega$																																																																																		
503	50 k $\Omega$																																																																																		
104	100 k $\Omega$																																																																																		
504	500 k $\Omega$																																																																																		
Code	Spec.																																																																																		
5	IP54																																																																																		
6	IP67																																																																																		
Code	Spec.																																																																																		
2	$\pm 2\%$																																																																																		
Code	Spec.																																																																																		
1	Left side (10mm)																																																																																		
2	Left side (8mm)																																																																																		
3	No lug																																																																																		
<table border="1"> <thead> <tr> <th>Code</th> <th>Spec.</th> </tr> </thead> <tbody> <tr> <td>2</td> <td>.250" (6.35mm)</td> </tr> <tr> <td>3</td> <td>.375" (9.53mm)</td> </tr> <tr> <td>4</td> <td>.500" (12.7mm)</td> </tr> <tr> <td colspan="2"><i>Diameter: 3/8" - 32UNEF-2A</i></td> </tr> <tr> <td colspan="2"><i>Length increment: 1/8"</i></td> </tr> <tr> <td>A</td> <td>5.0mm (.196")</td> </tr> <tr> <td>B</td> <td>7.5mm (.295")</td> </tr> <tr> <td>C</td> <td>10.0mm (.393")</td> </tr> <tr> <td colspan="2"><i>Diameter: M9 x .75P</i></td> </tr> <tr> <td colspan="2"><i>Length increment: 2.5mm</i></td> </tr> </tbody> </table>		Code	Spec.	2	.250" (6.35mm)	3	.375" (9.53mm)	4	.500" (12.7mm)	<i>Diameter: 3/8" - 32UNEF-2A</i>		<i>Length increment: 1/8"</i>		A	5.0mm (.196")	B	7.5mm (.295")	C	10.0mm (.393")	<i>Diameter: M9 x .75P</i>		<i>Length increment: 2.5mm</i>		<table border="1"> <thead> <tr> <th>Code</th> <th>Spec.</th> <th>Dia.</th> </tr> </thead> <tbody> <tr> <td>R*</td> <td>Round</td> <td>6mm</td> </tr> <tr> <td>F</td> <td>Flatted</td> <td>6mm</td> </tr> <tr> <td>K</td> <td>Split Knurl (24 Teeth)</td> <td>6mm</td> </tr> <tr> <td>S</td> <td>Slotted</td> <td>6mm</td> </tr> <tr> <td>O*</td> <td>Round</td> <td>.250"</td> </tr> <tr> <td>L</td> <td>Flatted</td> <td>.250"</td> </tr> <tr> <td>D</td> <td>Slotted</td> <td>.250"</td> </tr> </tbody> </table>		Code	Spec.	Dia.	R*	Round	6mm	F	Flatted	6mm	K	Split Knurl (24 Teeth)	6mm	S	Slotted	6mm	O*	Round	.250"	L	Flatted	.250"	D	Slotted	.250"	<table border="1"> <thead> <tr> <th>Code</th> <th>Spec.</th> </tr> </thead> <tbody> <tr> <td>A</td> <td><math>\pm 10\%</math></td> </tr> <tr> <td>B</td> <td><math>\pm 20\%</math></td> </tr> </tbody> </table>		Code	Spec.	A	$\pm 10\%$	B	$\pm 20\%$	<table border="1"> <thead> <tr> <th>Code</th> <th>Total</th> <th>Electrical</th> </tr> </thead> <tbody> <tr> <td>A</td> <td>250°</td> <td>240°</td> </tr> <tr> <td>B</td> <td>300°</td> <td>280°</td> </tr> <tr> <td>C</td> <td>360°</td> <td>340°</td> </tr> </tbody> </table>		Code	Total	Electrical	A	250°	240°	B	300°	280°	C	360°	340°												
Code	Spec.																																																																																		
2	.250" (6.35mm)																																																																																		
3	.375" (9.53mm)																																																																																		
4	.500" (12.7mm)																																																																																		
<i>Diameter: 3/8" - 32UNEF-2A</i>																																																																																			
<i>Length increment: 1/8"</i>																																																																																			
A	5.0mm (.196")																																																																																		
B	7.5mm (.295")																																																																																		
C	10.0mm (.393")																																																																																		
<i>Diameter: M9 x .75P</i>																																																																																			
<i>Length increment: 2.5mm</i>																																																																																			
Code	Spec.	Dia.																																																																																	
R*	Round	6mm																																																																																	
F	Flatted	6mm																																																																																	
K	Split Knurl (24 Teeth)	6mm																																																																																	
S	Slotted	6mm																																																																																	
O*	Round	.250"																																																																																	
L	Flatted	.250"																																																																																	
D	Slotted	.250"																																																																																	
Code	Spec.																																																																																		
A	$\pm 10\%$																																																																																		
B	$\pm 20\%$																																																																																		
Code	Total	Electrical																																																																																	
A	250°	240°																																																																																	
B	300°	280°																																																																																	
C	360°	340°																																																																																	

\*Not available with 360° rotation

### Electrical Specifications

Parameter	Conditions & Remarks	Min	Max	Unit
Resistance Range	Linear	1k	500k	Ω
	Audio	100k	500k	Ω
Resistance Tolerance	Standard	-20	+20	%
	Special	-10	+10	%
Dielectric Strength	1 minute		750	VDC
Power Rating (Standard)	@ 55°C		0.25	watt
Power Rating (Special)	@ 75°C		0.50	watt
Operating Voltage			500	VDC
Insulation Resistance	500 VDC	1000		MΩ
Linearity		+2	-2	%

### Mechanical and Environmental

Parameter	Conditions & Remarks	Min	Max	Unit
Operating Temperature		-40	+125	°C
Storage Temperature		-55	+150	°C
Rotational Torque		20	180	gf-cm
Rotational Life		2,000,000		cycles
Stop Strength		9		kgf-cm
Mechanical Angle	250°, 300° & 360°			
Vibration	15 G, 10 to 2000 Hz			
Push-Pull Strength of Shaft	13.6 kg for 10 seconds			
Ingress Protection Rating	IP54 & IP67			
Soldering Condition:	Maximum temperature of 350°C for 5 seconds			
Mounting Information	Bushing mount			
Packaging:	Standard tray packaging			

All testing is performed at room ambient conditions except as noted. Users should verify device actual performance in their specific applications. This product is compliant to RoHS3 Directive 2015/863 Amendments of Annex II on 31 March 2015, and REACH SVHC Directive EC 1907/2006 Amendments of Annex XIV & Annex XVII on 15 January 2018. Custom and value-added options available on request. Please contact your sales representative for additional information.

### Electrical and Mechanical Specifications

#### Resistance Tapers

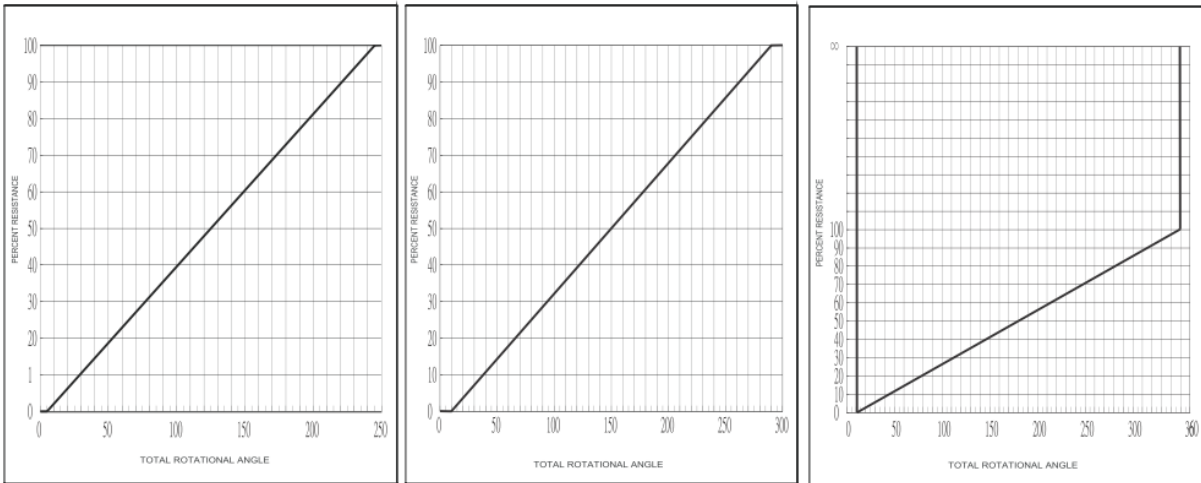

TOTAL ROTATIONAL ANGLE: 250

TOTAL ROTATIONAL ANGLE: 300°

TOTAL ROTATIONAL ANGLE: 360°

### Electrical and Mechanical Specifications

Series 282T Metal Shaft, Bushing Mount, Solder Lug "T" Type Terminals, 8 mm Locating Lug

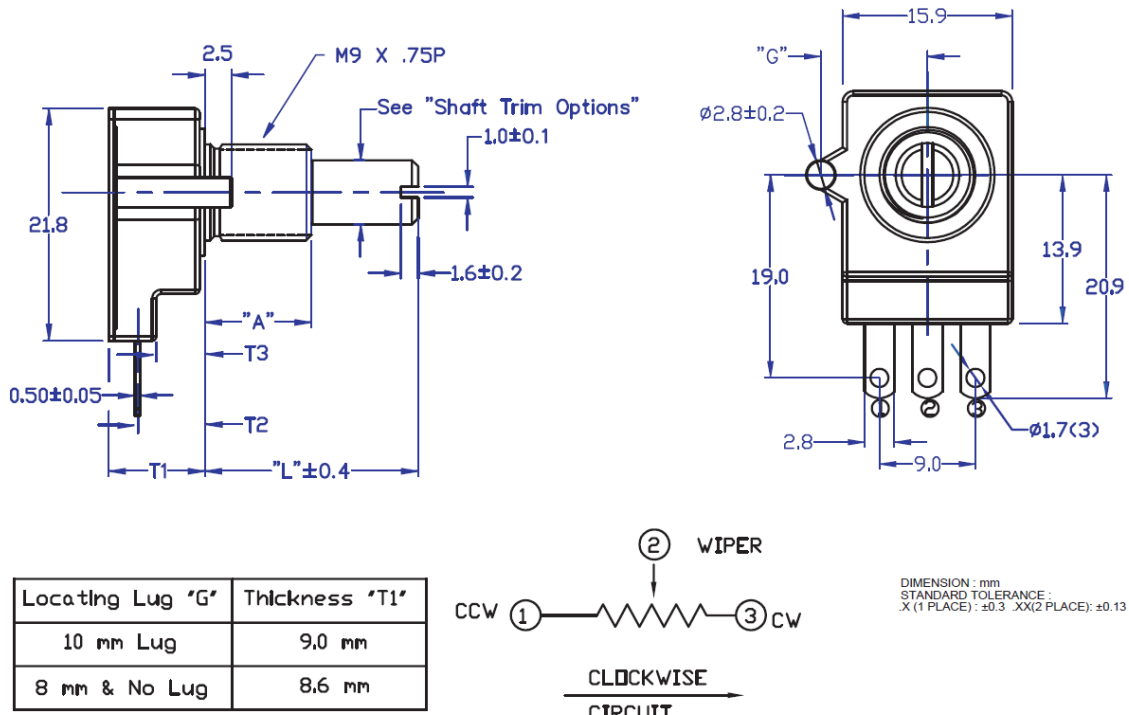

Series 282S Metal Shaft, Bushing Mount, Solder Lug "S" Type Terminal Formed to Rear

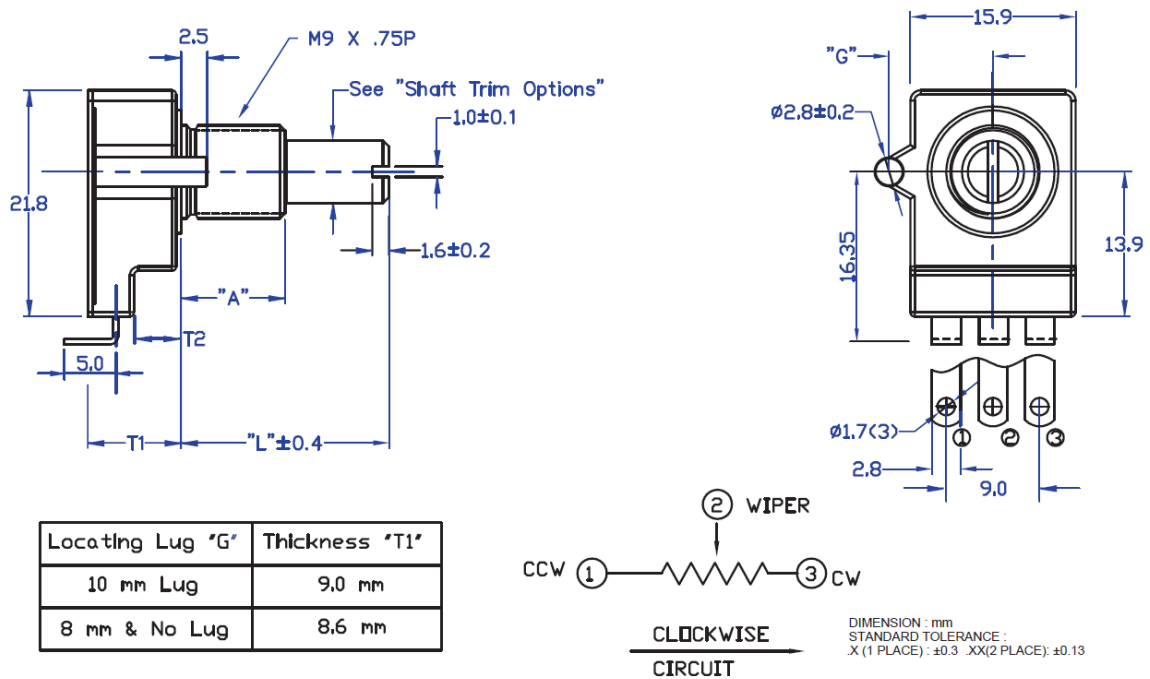

## Electrical and Mechanical Specifications

Series 282U Metal Shaft, Bushing Mount, PC "U" Type Terminal Formed to Front

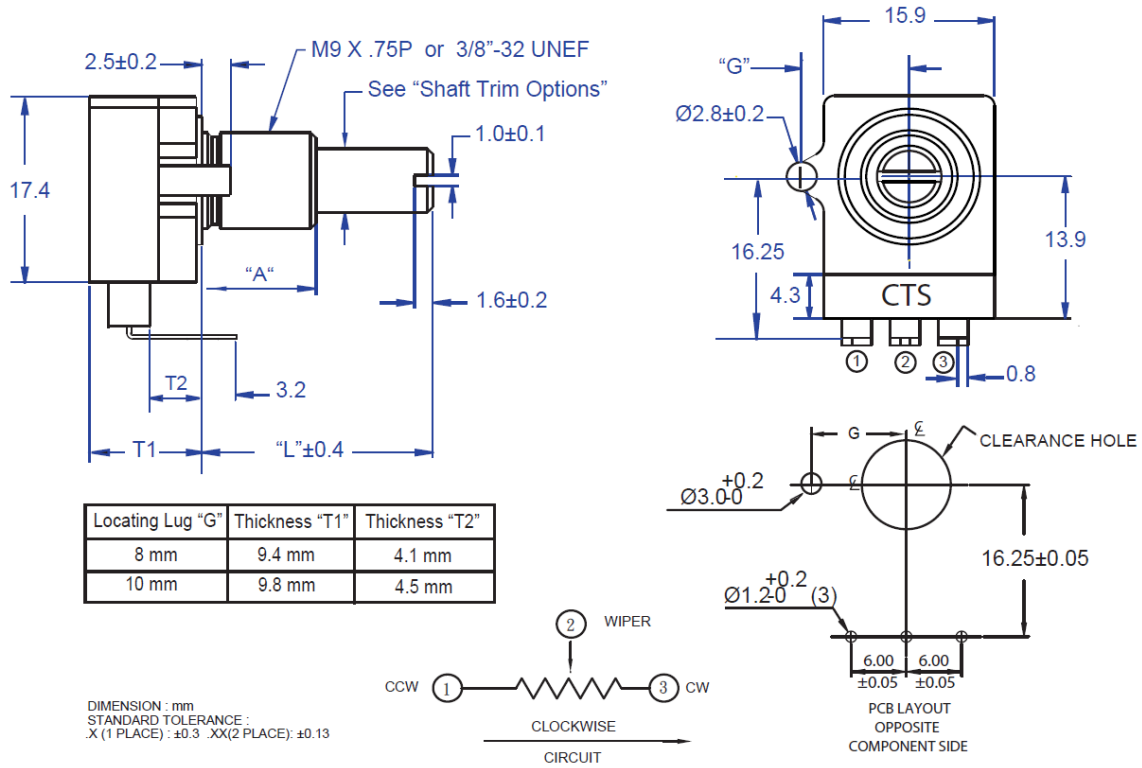

## Shaft Trim and Diameter Options



Shaft Trim	Diameter
R	.236" (6.00 mm)
O	.250" (6.35 mm)

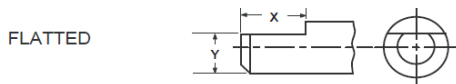

Shaft Trim	Diameter	X	Y
F	.236" (6.00 mm)	.375" (9.52 mm)	.156" (3.96 mm)
L	.250" (6.35 mm)	.440" (11.18 mm)	.217" (5.50 mm)

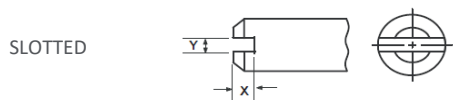

Shaft Trim	Diameter	X	Y
S	.236" (6.00 mm)	.063" (1.6mm)	.039" (1.0mm)
D	.250" (6.35 mm)	.063" (1.6mm)	.039" (1.0mm)

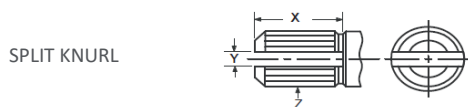

Shaft Trim	Diameter	X	Y	Z
K	.236" (6.00 mm)	.344" (8.74 mm)	.063" (1.60 mm)	24 Teeth

## Looking for pricing, stock, or lifecycle information?

Click below to explore more details on WIN SOURCE:

- ⊖ [View 282T33L502A26A2 on WIN SOURCE](#)
- ⊖ [CTS Electrocomponents Information](#)

## Optimize Your Supply Chain with WIN SOURCE Solutions

- ✓ Global Sourcing Solution
- ✓ Obsolete Management
- ✓ Cost Control Management
- ✓ Shortage Management
- ✓ Alternative Solution
- ✓ Excess Inventory Management