



**THE DATASHEET OF**  
**4752.5000**



Strip Block for Snap-in Mounting with 4 IEC Appliance Outlets F



Snap-in version

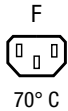

See below:  
[Approvals and Compliances](#)

**Description**

- Panel mount :  
 Snap-in version front side
- 1 Function :  
 Module of 4 outlets , Pin temperature 70 °C , Protection class I
- Solder / Quick Connect

**Characteristics**

- Busbar is of single piece (no soldering)
- Insulation cover on the rear-side
- Suitable for use in equipment according to IEC/UL 62368-1

**Weblinks**

[pdf data sheet](#), [html datasheet](#), [General Product Information](#), [Approvals](#), [Distributor-Stock-Check](#), [Accessories](#), [Detailed request for product](#)

**Technical Data**

Ratings IEC	10A / 250VAC; 50Hz	Appliance inlet/-outlet	F acc. to IEC 60320-3
Ratings UL/CSA	15A / 250VAC; 60Hz		UL 60320-1 CSA C22.2 no. 60320-1
Dielectric Strength	> 2 kVAC between L-N > 2 kVAC between L/N-PE (1 min/50Hz)		(for cold conditions) pin-temperature 70 °C, 10A, Protection Class I
Allowable Operation Temperature	-25 °C to 70 °C		
IP-Protection	front side IP30 acc. to IEC 60529		
Protection against electric shock	Suitable for appliances with protection class I acc. to IEC 61140		
Terminal	Solder / Quick Connect		
Panel Thickness S	Snap-in/1.2/1.5/2/2.5/3 mm tolerance +/- 0.05		
Material: Housing	Thermoplastic, black, UL 94V-0		

**Approvals and Compliances**

Detailed information on product approvals, code requirements, usage instructions and detailed test conditions can be looked up in [Details about Approvals](#)

SCHURTER products are designed for use in industrial environments. They have approvals from independent testing bodies according to national and international standards. Products with specific characteristics and requirements such as required in the automotive sector according to IATF 16949, medical technology according to ISO 13485 or in the aerospace industry can be offered exclusively with customer-specific, individual agreements by SCHURTER.

**Approvals**



The approval mark is used by the testing authorities to certify compliance with the safety requirements placed on electronic products.

Approval Reference Type:

Approval Logo	Certificates	Certification Body	Description
	<a href="#">VDE Approvals</a>	VDE	Certificate Number: 40030337
	<a href="#">UL Approvals</a>	UL	UR File Number: E103791
	<a href="#">CCC Approvals</a>	CCC	CCC Certificate Number: 2021180204021184

**Product standards**

Product standards that are referenced

Organization	Design	Standard	Description
	Designed according to	IEC 60320-1	Appliance couplers for household and similar general purposes
	Designed according to	IEC 60320-3	Appliance couplers for household and similar general purposes
	Designed according to	UL 60320-1	Standard for Attachment Plugs and Receptacles
	Designed according to	CSA C22.2 no. 60320-1	General Use Receptacles, Attachment Plugs, and Similar Wiring Devices





**Application standards**

Application standards where the product can be used

Organization	Design	Standard	Description
	Suitable for applications acc.	IEC/UL 62368-1	Audio/video, information and communication technology equipment - Part 1: Safety requirements

**Compliances**

The product complies with following Guide Lines

Identification	Details	Initiator	Description
	<a href="#">CE declaration of conformity</a>	SCHURTER AG	The CE marking declares that the product complies with the applicable requirements laid down in the harmonisation of Community legislation on its affixing in accordance with EU Regulation 765/2008.
	<a href="#">UKCA declaration of conformity</a>	SCHURTER AG	The UKCA marking declares that the product complies with the applicable requirements laid down in the British Amendment of Regulation (EC) 765/2008.
	RoHS	SCHURTER AG	Directive RoHS 2011/65/EU, Amendment (EU) 2015/863
	China RoHS	SCHURTER AG	The law SJ / T 11363-2006 (China RoHS) has been in force since 1 March 2007. It is similar to the EU directive RoHS.
	REACH	SCHURTER AG	On 1 June 2007, Regulation (EC) No 1907/2006 on the Registration, Evaluation, Authorization and Restriction of Chemicals 1 (abbreviated as "REACH") entered into force.

**Dimensions [mm]**

Quadbloc 4752

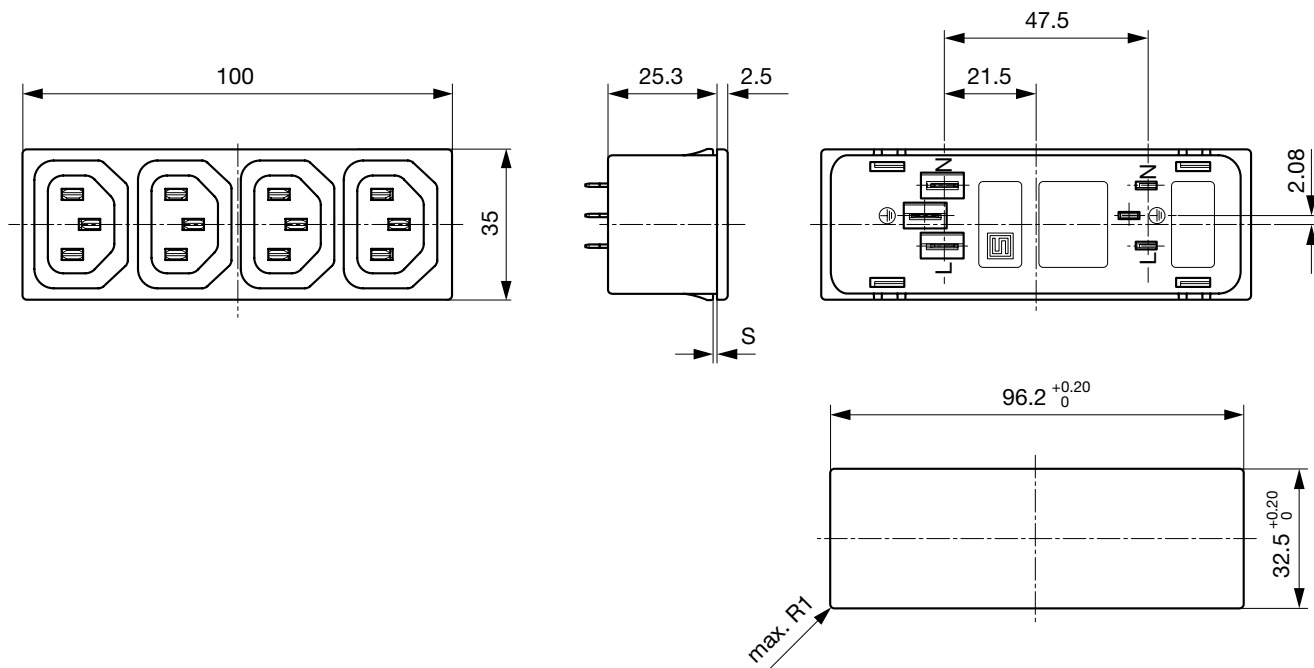

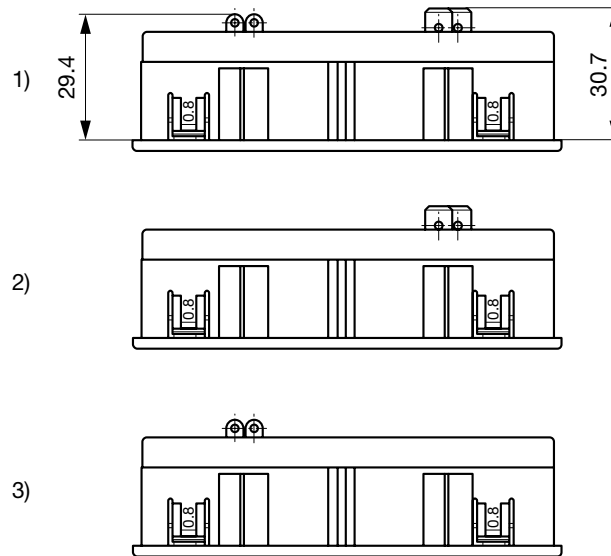

- 1) Solder and quick connect terminals 6.3x0.8 mm
- 2) only quick connect terminals 6.3x0.8 mm
- 3) only solder terminals

### Variants

Panel Thickness s [mm]	Terminal	Length [mm]	Order Number
1	Quick connect terminals 6.3 x 0.8 mm	100 mm	4752.3200
1.2	Quick connect terminals 6.3 x 0.8 mm	100 mm	4752.8200
1.5	Quick connect terminals 6.3 x 0.8 mm	100 mm	4752.4200
2	Quick connect terminals 6.3 x 0.8 mm	100 mm	4752.5200
2.5	Quick connect terminals 6.3 x 0.8 mm	100 mm	4752.6200
3	Quick connect terminals 6.3 x 0.8 mm	100 mm	4752.7200
1	Solder terminals 4 x 0.8 mm	100 mm	4752.3400
1.2	Solder terminals 4 x 0.8 mm	100 mm	4752.8400
1.5	Solder terminals 4 x 0.8 mm	100 mm	4752.4400
2	Solder terminals 4 x 0.8 mm	100 mm	4752.5400
2.5	Solder terminals 4 x 0.8 mm	100 mm	4752.6400
3	Solder terminals 4 x 0.8 mm	100 mm	4752.7400
1	Solder terminals 4 x 0.8 mm / quick connect terminals 6.3 x 0.8 mm	100 mm	4752.3000
1.2	Solder terminals 4 x 0.8 mm / quick connect terminals 6.3 x 0.8 mm	100 mm	4752.8000
1.5	Solder terminals 4 x 0.8 mm / quick connect terminals 6.3 x 0.8 mm	100 mm	4752.4000
2	Solder terminals 4 x 0.8 mm / quick connect terminals 6.3 x 0.8 mm	100 mm	4752.5000
2.5	Solder terminals 4 x 0.8 mm / quick connect terminals 6.3 x 0.8 mm	100 mm	4752.6000
3	Solder terminals 4 x 0.8 mm / quick connect terminals 6.3 x 0.8 mm	100 mm	4752.7000

Availability for all products can be searched real-time: <https://www.schurter.com/en/info-center/support-tools/stock-check-distributors>

Please note, all quadblocs are available in protection-class II upon request.

Cord retaining clamp see accessories

### Packaging unit

50 Pcs

**Mating Inlets/Plugs**

**Category / Description**

[Plug Overview complete](#)



4732, Mounting: Power Cord, Plug: IEC E, Cable	4732
4735, Mounting: Power Cord, Plug: IEC E, Cable	4735
9009, Mounting: Plug: IEC E, Screw clamps	9009
4733, Mounting: Power Cord, Plug: IEC E, Cable	4733
4736, Mounting: Power Cord, Plug: IEC E, Cable	4736
	...

## Looking for pricing, stock, or lifecycle information?

Click below to explore more details on WIN SOURCE:

 [View 4752.5000 on WIN SOURCE](#)

 [Schurter Inc. Information](#)

## Optimize Your Supply Chain with WIN SOURCE Solutions

-  Global Sourcing Solution
-  Obsolete Management
-  Cost Control Management
-  Shortage Management
-  Alternative Solution
-  Excess Inventory Management